



Online User's Guide

HL-L9310CDW

Table of Contents

Before You Use Your Brother Machine	1
Definitions of Notes	2
Notice - Disclaimer of Warranties (USA and Canada)	3
Trademarks	4
Important Note	5
Introduction to Your Brother Machine.....	6
Before Using Your Machine	7
Front View and Back View	8
Control Panel Overview	9
Touchscreen LCD Overview.....	11
How to Navigate the Touchscreen LCD	13
Access Brother Utilities (Windows®)	15
Uninstall the Brother Software and Drivers (Windows®)	17
Paper Handling.....	18
Load Paper.....	19
Load and Print Using the Paper Tray	20
Load and Print Using the Multi-purpose Tray (MP Tray)	24
Paper Settings.....	32
Change the Paper Size and Paper Type.....	33
Change the Check Paper Size Setting	34
Unprintable Area	35
Recommended Print Media	36
Using Special Paper.....	37
Print	38
Print from Your Computer (Windows®)	39
Print a Document (Windows®).....	40
Print Settings (Windows®).....	42
Secure Print (Windows®).....	46
Change the Default Print Settings (Windows®).....	47
Print a Document Using the BR-Script3 Printer Driver (PostScript® 3™ Language Emulation) (Windows®)	49
Monitor the Status of the Machine from Your Computer (Windows®)	50
Print from Your Computer (Macintosh).....	51
Print a Document (Macintosh).....	52
Print Options (Macintosh).....	53
Secure Print (Macintosh).....	59
Print a Document Using the BR-Script3 Printer Driver (PostScript® 3™ language emulation) (Macintosh).....	60
Monitor the Status of the Machine from Your Computer (Macintosh).....	61
Cancel a Print Job.....	63
Test Print	64
Print Data Directly from a USB Flash Drive	65
Compatible USB Flash Drives.....	66
Print Data Directly from a USB Flash Drive or Digital Camera Supporting Mass Storage.....	67

Create a PRN File for Direct Printing (Windows®)	69
Network	70
Supported Basic Network Features	71
Network Management Software and Utilities	72
Learn about Network Management Software and Utilities	73
Additional Methods of Configuring Your Brother Machine for a Wireless Network	74
Before Configuring Your Brother Machine for a Wireless Network.....	75
Configure Your Machine for a Wireless Network.....	76
Configure Your Machine for a Wireless Network Using the One Push Method of Wi-Fi Protected Setup™ (WPS).....	77
Configure Your Machine for a Wireless Network Using the PIN Method of Wi-Fi Protected Setup™ (WPS).....	78
Configure Your Machine for a Wireless Network Using the Machine's Control Panel Setup Wizard .	81
Configure Your Machine for a Wireless Network When the SSID Is Not Broadcast	83
Configure Your Machine for an Enterprise Wireless Network	85
Use Wi-Fi Direct®	88
Advanced Network Features.....	97
Print the Network Configuration Report.....	98
Print the WLAN Report.....	99
Configure the SNMP Protocol Using Web Based Management	102
Technical Information for Advanced Users.....	104
Gigabit Ethernet (Wired Network Only)	105
Reset the Network Settings to the Factory Settings.....	107
Security	108
Lock the Machine Settings	109
Setting Lock Overview.....	110
Network Security Features.....	114
Before Using Network Security Features	115
Secure Function Lock 3.0.....	116
Use Active Directory® Authentication	122
Use LDAP Authentication	126
Manage Your Network Machine Securely Using SSL/TLS.....	130
Manage Your Network Machine Securely Using IPsec	163
Send an Email Securely	181
Use IEEE 802.1x Authentication for a Wired or a Wireless Network	186
Store Print Log to Network	191
Mobile/Web Connect.....	196
Brother Web Connect.....	197
Brother Web Connect Overview	198
Online Services Used with Brother Web Connect.....	199
Conditions for Using Brother Web Connect.....	201
Set Up Brother Web Connect.....	205
Download and Print Documents Using Brother Web Connect	213
Google Cloud Print.....	215
Google Cloud Print Overview	216
Before Using Google Cloud Print	217
Print from Google Chrome™ or Chrome OS™	221

Print from Google Drive™ for Mobile	222
Print from Gmail™ Webmail Service for Mobile	223
AirPrint	224
AirPrint Overview	225
Before Using AirPrint	226
Print Using AirPrint	229
Mobile Printing for Windows®	233
Mopria® Print Service	234
Brother iPrint&Scan	235
Near-Field Communication (NFC)	236
Register an External IC Card Reader	237
Troubleshooting	238
Error and Maintenance Messages	239
Error Messages When Using the Brother Web Connect Feature	244
Paper Jams	246
Paper is Jammed in the MP tray	247
Paper is Jammed in the Paper Tray	248
Paper is Jammed in the Back of the Machine	250
Paper is Jammed Inside the Machine	252
Paper is Jammed underneath the Paper Tray	255
Printing Problems	257
Improve the Print Quality	260
Network Problems	266
Error Messages	267
Use the Network Connection Repair Tool (Windows®)	269
Where Can I Find My Brother Machine's Network Settings?	270
I Cannot Complete the Wireless Network Setup Configuration	271
My Brother Machine Cannot Print over the Network	273
I Want to Check that My Network Devices are Working Correctly	275
Google Cloud Print Problems	276
AirPrint Problems	277
Other Problems	278
Check the Machine Information	280
Reset Functions	281
Machine Reset	282
Network Reset	283
Factory Reset	284
Routine Maintenance	285
Replace Supplies	286
Replace the Toner Cartridge	288
Replace the Drum Unit	291
Replace the Belt Unit	295
Replace the Waste Toner Box	298
Reset the Drum Counter	302
Reset the Belt Unit Counter	303
Clean the Machine	304







Clean the Laser Scanner Windows	306
Clean the Touchscreen LCD	309
Clean the Corona Wires	310
Clean the Drum Unit.....	312
Clean the Paper Pick-up Rollers	317
Calibrate Color Output	318
Reset the Machine's Calibration Settings.....	319
Correct Color Print Alignment (Color Registration)	320
Check the Remaining Part Life	321
Pack and Ship Your Brother Machine	322
Replace Periodic Maintenance Parts	324
Machine Settings.....	325
Change Machine Settings from the Control Panel.....	326
General Settings.....	327
Settings and Features Tables	336
Change Machine Settings from Your Computer.....	347
Change Machine Settings Using Web Based Management	348
Appendix.....	352
Specifications	353
How to Enter Text on Your Brother Machine	358
Supplies	359
Important Information About Toner Cartridge Life	361
Accessories.....	362
Brother Numbers.....	363

Before You Use Your Brother Machine

- [Definitions of Notes](#)
- [Notice - Disclaimer of Warranties \(USA and Canada\)](#)
- [Trademarks](#)
- [Important Note](#)

Definitions of Notes

We use the following symbols and conventions throughout this User's Guide:

 WARNING	WARNING indicates a potentially hazardous situation which, if not avoided, could result in death or serious injuries.
 CAUTION	CAUTION indicates a potentially hazardous situation which, if not avoided, may result in minor or moderate injuries.
IMPORTANT	IMPORTANT indicates a potentially hazardous situation which, if not avoided, may result in damage to property or loss of product functionality.
NOTE	NOTE specifies the operating environment, conditions for installation, or special conditions of use.
	Tips icons indicate helpful hints and supplementary information.
	Electrical Hazard icons alert you to possible electrical shock.
	Fire Hazard icons alert you to the possibility of a fire.
	Hot Surface icons warn you not to touch hot machine parts.
	Prohibition icons indicate actions you must not perform.
Bold	Bold style identifies buttons on the machine's control panel or computer screen.
<i>Italics</i>	Italicized style emphasizes an important point or refers you to a related topic.
Courier New	Courier New font identifies messages shown on the machine's LCD.

Related Information

- [Before You Use Your Brother Machine](#)

Notice - Disclaimer of Warranties (USA and Canada)

BROTHER'S LICENSOR(S), AND THEIR DIRECTORS, OFFICERS, EMPLOYEES OR AGENTS (COLLECTIVELY BROTHER'S LICENSOR) MAKE NO WARRANTIES, EXPRESS OR IMPLIED, INCLUDING WITHOUT LIMITATION THE IMPLIED WARRANTIES OF MERCHANTABILITY AND FITNESS FOR A PARTICULAR PURPOSE, REGARDING THE SOFTWARE. BROTHER'S LICENSOR(S) DOES NOT WARRANT, GUARANTEE OR MAKE ANY REPRESENTATIONS REGARDING THE USE OR THE RESULTS OF THE USE OF THE SOFTWARE IN TERMS OF ITS CORRECTNESS, ACCURACY, RELIABILITY, CURRENTNESS OR OTHERWISE. THE ENTIRE RISK AS TO THE RESULTS AND PERFORMANCE OF THE SOFTWARE IS ASSUMED BY YOU. THE EXCLUSION OF IMPLIED WARRANTIES IS NOT PERMITTED BY SOME STATES IN THE USA AND SOME PROVINCES IN CANADA. THE ABOVE EXCLUSION MAY NOT APPLY TO YOU.

IN NO EVENT WILL BROTHER'S LICENSOR(S) BE LIABLE TO YOU FOR ANY CONSEQUENTIAL, INCIDENTAL OR INDIRECT DAMAGES (INCLUDING DAMAGES FOR LOSS OF BUSINESS PROFITS, BUSINESS INTERRUPTION, LOSS OF BUSINESS INFORMATION, AND THE LIKE) ARISING OUT OF THE USE OR INABILITY TO USE THE SOFTWARE EVEN IF BROTHER'S LICENSOR HAS BEEN ADVISED OF THE POSSIBILITY OF SUCH DAMAGES. BECAUSE SOME STATES IN THE USA AND SOME PROVINCES IN CANADA DO NOT ALLOW THE EXCLUSION OR LIMITATION OF LIABILITY FOR CONSEQUENTIAL OR INCIDENTAL DAMAGES, THE ABOVE LIMITATIONS MAY NOT APPLY TO YOU. IN ANY EVENT BROTHER'S LICENSOR'S LIABILITY TO YOU FOR ACTUAL DAMAGES FROM ANY CAUSE WHATSOEVER, AND REGARDLESS OF THE FORM OF THE ACTION (WHETHER IN CONTRACT, TORT (INCLUDING NEGLIGENCE), PRODUCT LIABILITY OR OTHERWISE), WILL BE LIMITED TO \$50.



Related Information

- [Before You Use Your Brother Machine](#)

Trademarks

BROTHER is either a trademark or a registered trademark of Brother Industries, Ltd.

Microsoft, Windows, Windows Server, Internet Explorer, Active Directory, OneNote and OneDrive are either registered trademarks or trademarks of Microsoft Corporation in the United States and/or other countries.

Apple, Macintosh, Safari, iPad, iPhone and iPod touch are trademarks of Apple Inc., registered in the United States and other countries.

AirPrint and macOS are trademarks of Apple Inc.

PostScript and PostScript 3 are either registered trademarks or trademarks of Adobe Systems Incorporated in the United States and/or other countries.

Wi-Fi, Wi-Fi Alliance and Wi-Fi Direct are registered trademarks of Wi-Fi Alliance®.

WPA, WPA2, Wi-Fi CERTIFIED, Wi-Fi Protected Setup and Wi-Fi Protected Setup logo are trademarks of Wi-Fi Alliance®.

Android, Gmail, Google Cloud Print, Google Drive, Google Chrome, Chrome OS and Google Play are trademarks of Google, Inc. Use of these trademarks is subject to Google Permissions.

Mopria® is a registered trademark and a service mark of Mopria Alliance, Inc. in the United States and other countries. Unauthorized use is strictly prohibited.

Mozilla and Firefox are registered trademarks of the Mozilla Foundation.

Intel is a trademark of Intel Corporation in the U.S. and/or other countries.

Evernote is a trademark of Evernote Corporation and used under a license.

The Bluetooth word mark is owned by the Bluetooth SIG, Inc. and any use of such marks by Brother Industries, Ltd. is under license.

PictBridge is a trademark.

Each company whose software title is mentioned in this manual has a Software License Agreement specific to its proprietary programs.

Any trade names and product names of companies appearing on Brother products, related documents and any other materials are all trademarks or registered trademarks of those respective companies.



Related Information

- [Before You Use Your Brother Machine](#)

Important Note

- Do not use this product outside the country of purchase as it may violate the wireless telecommunication and power regulations of that country.
- Not all models are available in all countries.
- Windows® 10 in this document represents Windows® 10 Home, Windows® 10 Pro, Windows® 10 Education and Windows® 10 Enterprise.
- Windows Server® 2008 in this document represents Windows Server® 2008 and Windows Server® 2008 R2.
- The screens in this User's Guide are for illustration purposes only and may differ from the actual screens.
- Unless otherwise specified, the screens in this manual are from Windows® 7 and macOS v10.10.5 Screens on your computer may vary depending on your operating system.
- The contents of this guide and the specifications of this product are subject to change without notice.
- Not all features are available in countries subject to applicable export restrictions.



Related Information

- [Before You Use Your Brother Machine](#)
-

Introduction to Your Brother Machine

- [Before Using Your Machine](#)
- [Front View and Back View](#)
- [Control Panel Overview](#)
- [Touchscreen LCD Overview](#)
- [How to Navigate the Touchscreen LCD](#)
- [Access Brother Utilities \(Windows®\)](#)

Before Using Your Machine

Before attempting any printing operation, confirm the following:

- Make sure you have installed the printer driver.
- For USB or network cable users: Make sure the interface cable is physically secure.

Firewall (Windows®)

If your computer is protected by a firewall and you are unable to network print, you may need to configure the firewall settings. If you are using the Windows® Firewall and you installed the drivers using the steps in the installer, the necessary firewall settings have been already set. If you are using any other personal firewall software, see the User's Guide for your software or contact the software manufacturer.



Related Information

- [Introduction to Your Brother Machine](#)
-

Front View and Back View

Front View

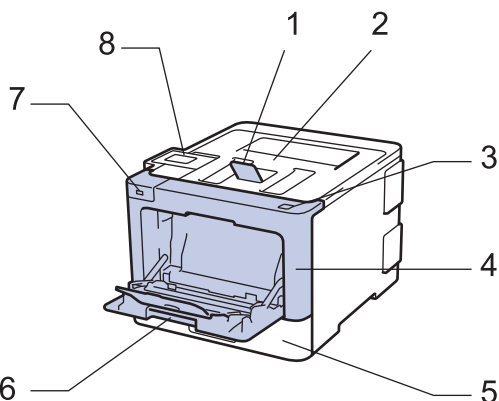

Back View

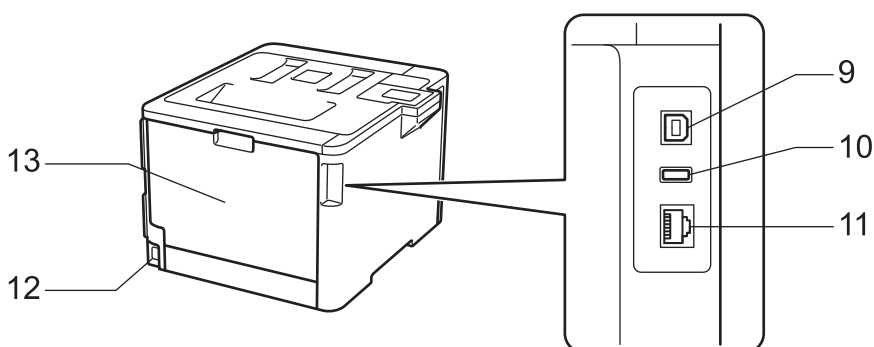

1. Face down output tray support flap (support flap)
2. Face down output tray
3. Front cover release button
4. Front cover
5. Paper tray
6. Multi-purpose tray (MP tray)
7. USB accessory port
8. Touch panel with a tiltable Touchscreen LCD
9. USB port
10. USB accessory port (HL-L9310CDW)
11. (For wired network models)
10BASE-T / 100BASE-TX / 1000BASE-T port
12. AC power connector / cord
13. Back cover (Face up output tray)



Related Information

- [Introduction to Your Brother Machine](#)

Control Panel Overview

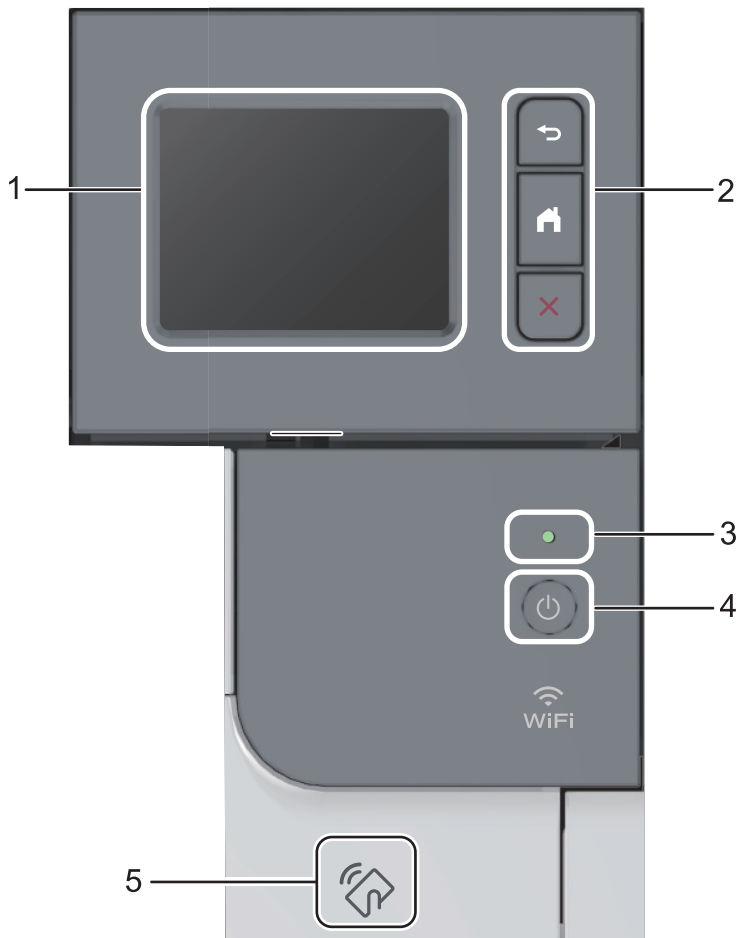

1. Touchscreen Liquid Crystal Display (LCD)

Access menus and options by pressing them on the Touchscreen.

2. Menu buttons



(Back)

Press to go back to the previous menu.



(Home)

Press to return to the Home screen.





(Cancel)

Press to cancel an operation.

3. LED Power Indicator

The LED lights up depending on the machine's power status.

4. Power On/Off

- Turn on the machine by pressing .
- Turn off the machine by pressing and holding down .

5. Near Field Communication (NFC) Reader

You can use card authentication by touching the IC card to the NFC Reader on the control panel. If your Android™ device supports the NFC feature, you can print from your device in the same way.



Related Information

- [Introduction to Your Brother Machine](#)
-

Touchscreen LCD Overview

From the Home screen, access the WiFi setup, Toner level, Settings, and Functions screens.

The Home screen displays the machine's status when the machine is idle. When displayed, this screen indicates that your machine is ready for the next command.

If Active Directory® Authentication or LDAP Authentication is enabled, the machine's control panel is locked.

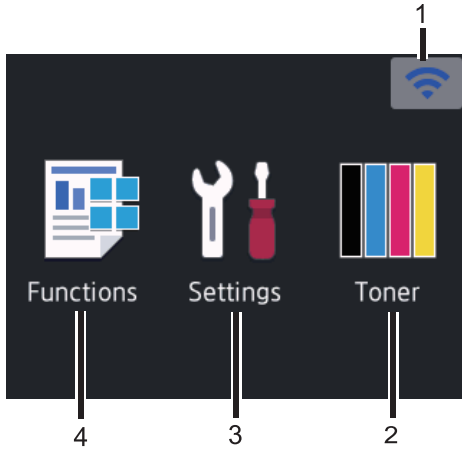

1. (Wireless Status)

If you are using a wireless connection, a four-level indicator in the Home screen displays the current wireless signal strength.



- If you see  at the top on the screen, press to select a wireless connection method, or edit an existing wireless connection.

2. [Toner]

Displays the remaining toner life. Press to access the [Toner] menu.

3. [Settings]



Press to access the [Settings] menu.

Use the Settings menu to access all of your Brother machine's settings.

If Setting Lock has been turned on, a lock icon  appears on the LCD. You must unlock the machine to change any settings.

4. [Functions]

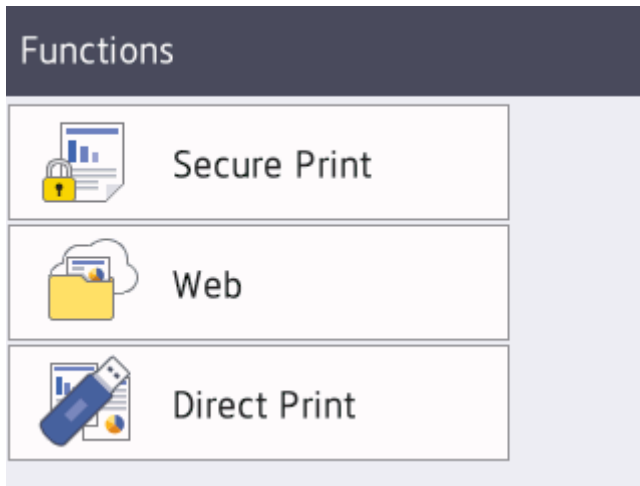

Press to access the Functions screen.

-  [Secure Print]
Press to access the Secure Print option.
-  [Web]
Press to connect the Brother machine to an Internet service.
-  [Direct Print]
Press to access the Direct Print menu.

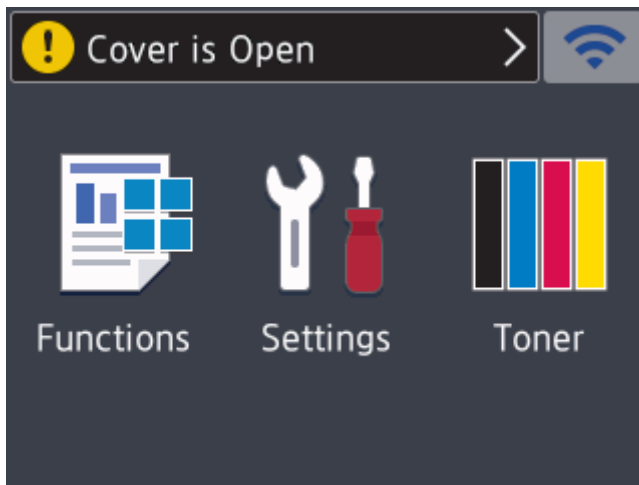

Warning icon



The warning icon  appears when there is an error or maintenance message; press  to view it, and then press  to return to Ready Mode.

NOTE

This product adopts the font of ARPHIC TECHNOLOGY CO.,LTD.

Related Information

- [Introduction to Your Brother Machine](#)

How to Navigate the Touchscreen LCD

Press your finger on the LCD to operate it. To display and access all the options, press ▲ or ▼ on the LCD to scroll through them.

The following steps explain how to navigate through changing the machine's setting. In this example, the LCD Backlight setting is changed from [Light] to [Med]:

IMPORTANT

DO NOT press the LCD with a sharp object such as a pen or stylus. It may damage the machine.

NOTE

DO NOT touch the LCD immediately after plugging in the power cord or turning on the machine. Doing this may cause an error.

1. Press  [Settings] > [All Settings].
2. Press ▲ or ▼ to display the [General Setup] option, and then press [General Setup].

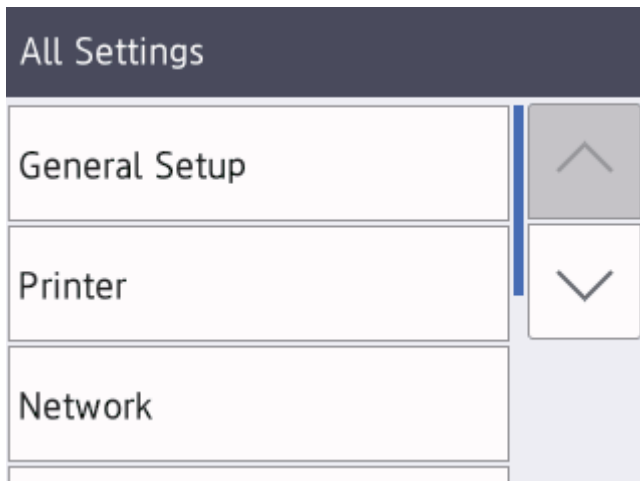

3. Press ▲ or ▼ to display the [LCD Settings] option, and then press [LCD Settings].

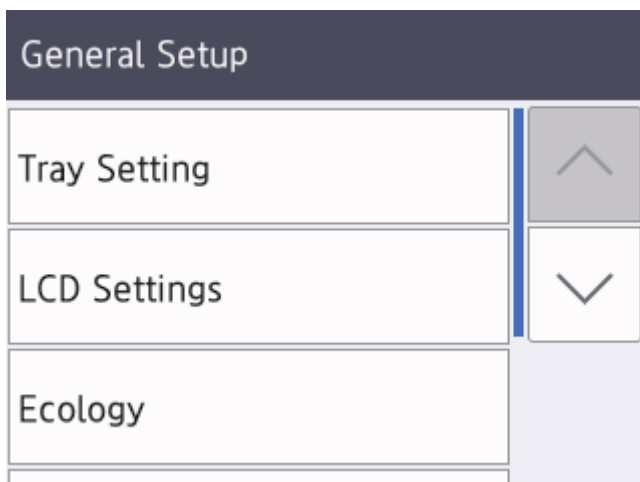

4. Press [Backlight].

LCD Settings

Backlight	Light
-----------	-------

Dim Timer	30Secs
-----------	--------

5. Press [Med].

Backlight

Light

Med

Dark

6. Press .



Related Information

- [Introduction to Your Brother Machine](#)

Access Brother Utilities (Windows®)

Brother Utilities is an application launcher that offers convenient access to all Brother applications installed on your computer.

1. Do one of the following:

- (Windows® 7, Windows Server® 2008 and Windows Server® 2008 R2)

Click  (**Start**) > **All Programs** > **Brother** > **Brother Utilities**.

- (Windows® 8 and Windows Server® 2012)

Tap or click  (**Brother Utilities**) either on the **Start** screen or the desktop.

- (Windows® 8.1 and Windows Server® 2012 R2)

Move your mouse to the lower left corner of the **Start** screen and click  (if you are using a touch-based device, swipe up from the bottom of the **Start** screen to bring up the **Apps** screen).

When the **Apps** screen appears, tap or click  (**Brother Utilities**).

- (Windows® 10 and Windows Server® 2016)

Click  **Brother** > **Brother Utilities**.

2. Select your machine (where XXXX is the name of your model).

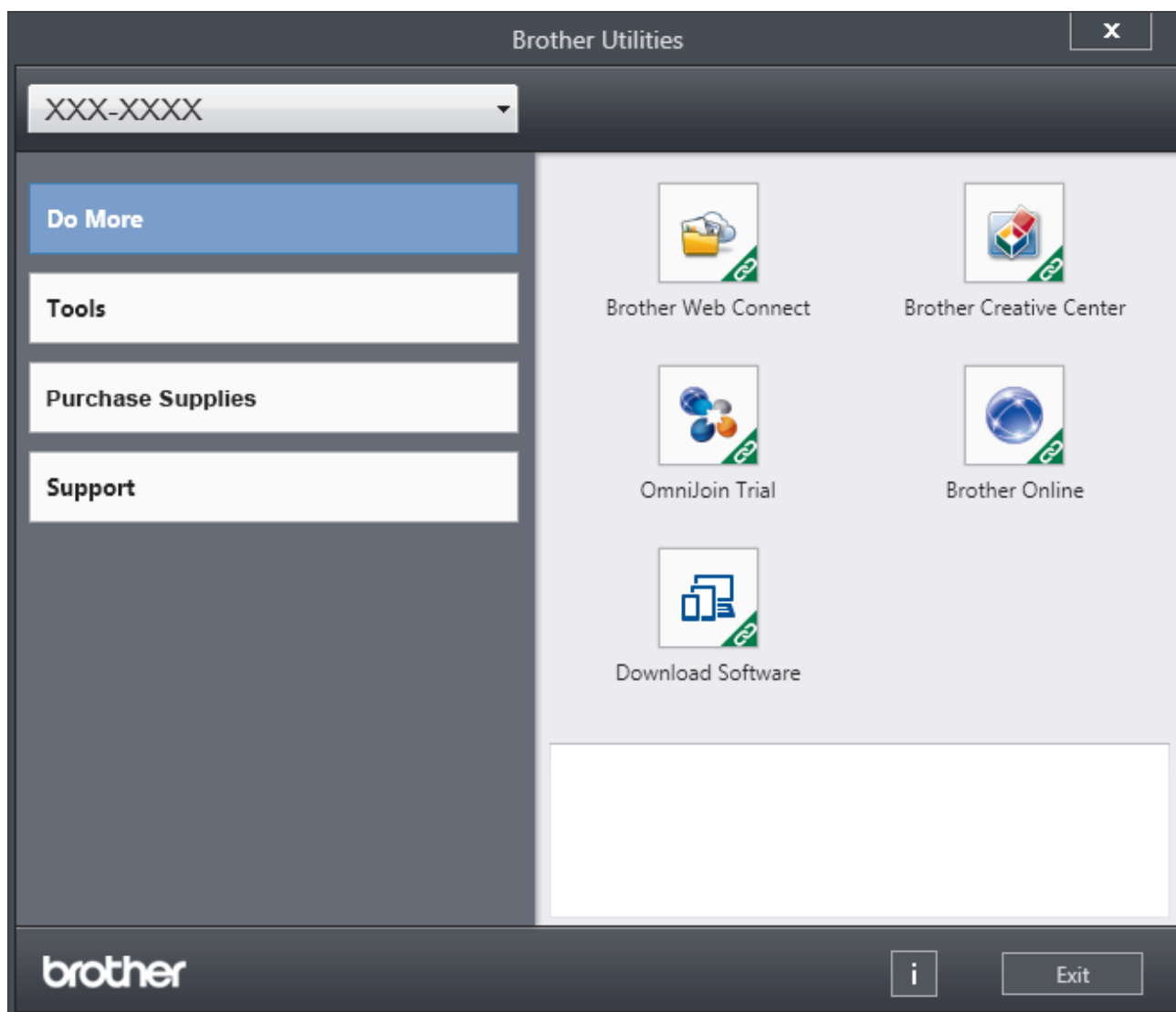

3. Choose the operation you want to use.



Related Information

- [Introduction to Your Brother Machine](#)
 - [Uninstall the Brother Software and Drivers \(Windows®\)](#)
-

Uninstall the Brother Software and Drivers (Windows®)

1. Do one of the following:

- (Windows® 7, Windows Server® 2008 and Windows Server® 2008 R2)

Click  (**Start**) > **All Programs** > **Brother** > **Brother Utilities**.

- (Windows® 8 and Windows Server® 2012)

Tap or click  (**Brother Utilities**) either on the **Start** screen or the desktop.

- (Windows® 8.1 and Windows Server® 2012 R2)

Move your mouse to the lower left corner of the **Start** screen and click  (if you are using a touch-based device, swipe up from the bottom of the **Start** screen to bring up the **Apps** screen).

When the **Apps** screen appears, tap or click  (**Brother Utilities**).

- (Windows® 10 and Windows Server® 2016)

Click  **Brother** > **Brother Utilities**.

2. Click the drop-down list, and then select your model name (if not already selected). Click **Tools** in the left navigation bar, and then click **Uninstall**.

Follow the instructions in the dialog box to uninstall the software and drivers.



Related Information

- [Access Brother Utilities \(Windows®\)](#)

Paper Handling

- [Load Paper](#)
- [Paper Settings](#)
- [Unprintable Area](#)
- [Recommended Print Media](#)
- [Using Special Paper](#)

Load Paper

- [Load and Print Using the Paper Tray](#)
- [Load and Print Using the Multi-purpose Tray \(MP Tray\)](#)

Load and Print Using the Paper Tray

- [Load Paper in the Paper Tray](#)
- [Printing Problems](#)
- [Error and Maintenance Messages](#)

Load Paper in the Paper Tray

- If the Check Size setting is set to On and you pull the paper tray out of the machine, a message appears on the LCD asking if you want to change the paper size and paper type. Change the paper size and paper type settings if needed, following the LCD instructions.
- When you load a different size and type of paper in the tray, you must also change the Paper Size and Paper Type settings in the machine, or on your computer.

1. Pull the paper tray completely out of the machine.

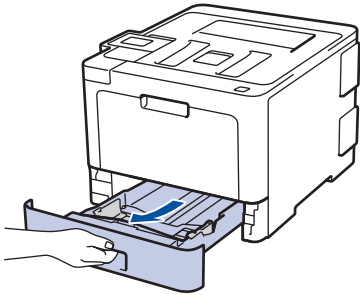

2. Press and slide the paper guides to fit the paper.
Press the green release levers to slide the paper guides.

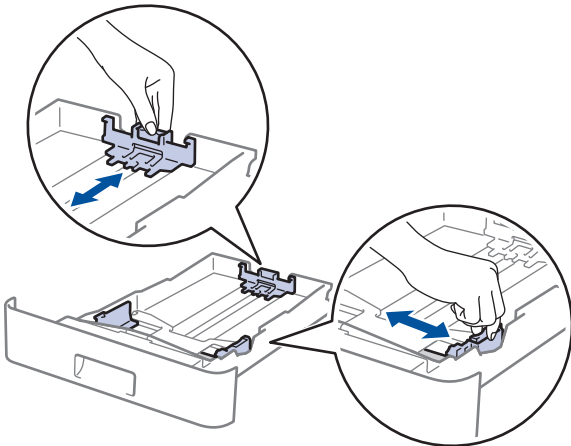

3. Fan the stack of paper well.
4. Load paper in the paper tray with the printing surface *face down*.



When you use letterhead or preprinted paper, load the paper in the correct orientation. See *Related Information: Change Machine Settings to Print on Letterhead or Preprinted Paper Using the Paper Tray*.

5. Make sure the paper is below the maximum paper mark (▼▼▼).
Overfilling the paper tray will cause paper jams.

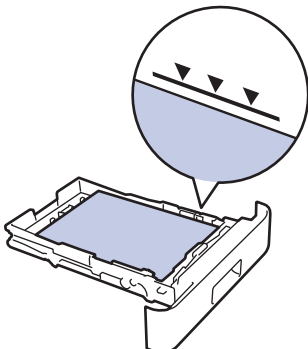

6. Slowly push the paper tray completely into the machine.

7. Lift the support flap to prevent paper from sliding off the output tray.

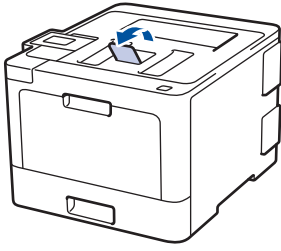

Related Information

- [Load and Print Using the Paper Tray](#)
 - [Change Machine Settings to Print on Letterhead or Preprinted Paper Using the Paper Tray](#)
-

Change Machine Settings to Print on Letterhead or Preprinted Paper Using the Paper Tray



When you use letterhead or preprinted paper for 2-sided printing, change the machine's settings.

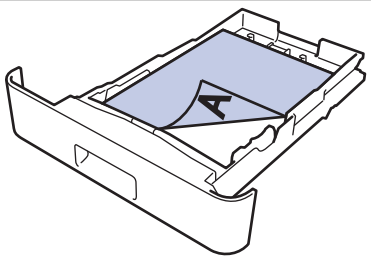
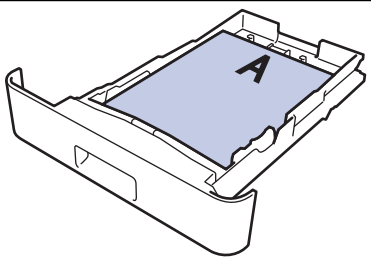

DO NOT load different sizes and types of paper in the paper tray at the same time. Doing this may cause the paper to jam or misfeed.

Orientation

	<p>For 1-sided printing</p> <ul style="list-style-type: none">• face down• top edge toward the front of the paper tray
	<p>For automatic 2-sided printing (long edge binding)</p> <ul style="list-style-type: none">• face up• bottom edge toward the front of the paper tray

1. Press  [Settings] > [All Settings] > [Printer] > [2-sided] > [Single Image] > [2-sided Feed].
2. Press .



Related Information

- [Load Paper in the Paper Tray](#)

Load and Print Using the Multi-purpose Tray (MP Tray)

You can load letterhead, colored paper, thin paper, thick paper, recycled paper, bond paper, labels, glossy paper, up to 50 sheets of plain paper, or up to ten envelopes in the MP tray.

- [Load Paper in the Multi-purpose Tray \(MP Tray\)](#)
- [Load and Print Labels Using the MP Tray](#)
- [Load and Print Envelopes Using the MP Tray](#)
- [Printing Problems](#)
- [Error and Maintenance Messages](#)

Load Paper in the Multi-purpose Tray (MP Tray)

When you load a different size and type of paper in the tray, you must also change the Paper Size and Paper Type settings in the machine, or on your computer.

- Plain Paper
- Letterhead
- Colored Paper
- Thin Paper
- Thick Paper
- Recycled Paper
- Bond
- Glossy Paper

1. Lift the support flap to prevent paper from sliding off the face down output tray.

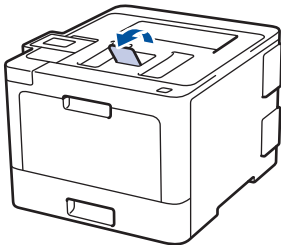

2. Open the MP tray and lower it gently.

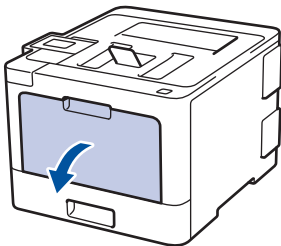

3. Pull out the MP tray support (1) and unfold the flap (2).

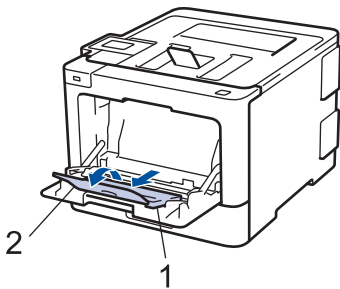

4. Slide the MP tray paper guides to fit the width of the paper you are using. If the paper guide on the right side has a lever, press it and slide the paper guide.

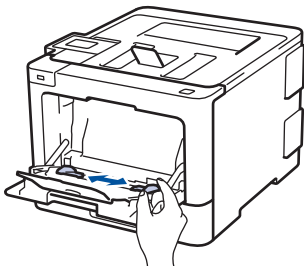

5. Load paper with the printing surface *face up* in the MP tray.

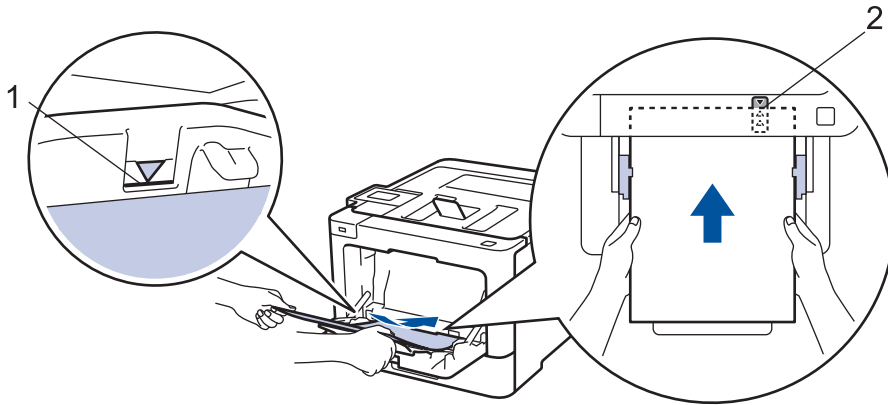

- Make sure the paper is below the maximum paper mark (1).
- Place the paper's leading edge (top of paper) between the ▲ and ▼ arrows (2).
- When using glossy paper, load only one sheet at a time in the MP tray to avoid a paper jam.
- When you use letterhead or preprinted paper, load the paper in the correct orientation. See *Related Information: Change Machine Settings to Print on Letterhead or Preprinted Paper Using the MP Tray*.



Related Information

- [Load and Print Using the Multi-purpose Tray \(MP Tray\)](#)
- [Change Machine Settings to Print on Letterhead or Preprinted Paper Using the MP Tray](#)

Change Machine Settings to Print on Letterhead or Preprinted Paper Using the MP Tray



When you use letterhead or preprinted paper for 2-sided printing, change the machine's settings.

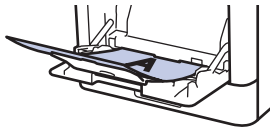
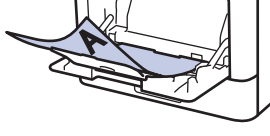

DO NOT load different sizes and types of paper in the paper tray at the same time. Doing this may cause the paper to jam or misfeed.

Orientation

	For 1-sided printing <ul style="list-style-type: none">• face up• top edge first
	For automatic 2-sided printing (long edge binding) <ul style="list-style-type: none">• face down• bottom edge first

1. Press  [Settings] > [All Settings] > [Printer] > [2-sided] > [Single Image] > [2-sided Feed].
2. Press .



Related Information

- [Load Paper in the Multi-purpose Tray \(MP Tray\)](#)

Load and Print Labels Using the MP Tray

When the back cover (face up output tray) is pulled down, the machine has a straight paper path from the MP tray through to the back of the machine. Use this paper feed and output method when you print on labels.

When you load a different size and type of paper in the tray, you must also change the Paper Size and Paper Type settings in the machine, or on your computer.

1. Open the machine's back cover (the face up output tray).

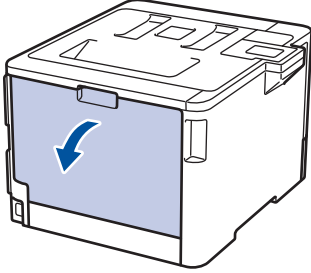

2. On the front of the machine, open the MP tray and lower it gently.

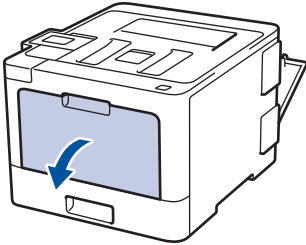

3. Pull out the MP tray support (1) and unfold the flap (2).

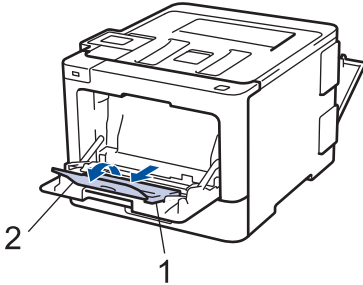

4. Slide the MP tray paper guides to fit the width of the paper that you are using. If the paper guide on the right side has a lever, press it and slide the paper guide.

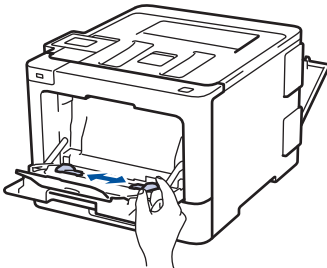

5. Load paper with the printing surface *face up* in the MP tray.

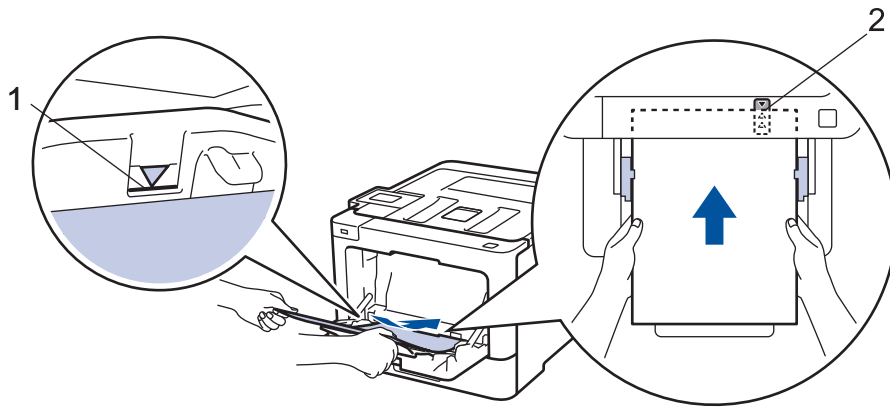

- Make sure the paper is below the maximum paper mark (1).
- Place the paper's leading edge (top of paper) between the ▲ and ▼ arrows (2).

6. Change your print preferences in the Print screen before sending the print job from your computer.
7. Send your print job to the machine.
8. Close the back cover (the face up output tray) until it locks in the closed position.



Related Information

- [Load and Print Using the Multi-purpose Tray \(MP Tray\)](#)

Load and Print Envelopes Using the MP Tray

You can load up to ten envelopes in the MP tray.

Before loading, press the corners and sides of the envelopes to make them as flat as possible.

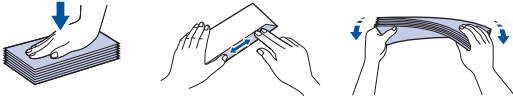

When you load a different size and type of paper in the tray, you must also change the Paper Size and Paper Type settings in the machine, or on your computer.

1. Open the machine's back cover (the face up output tray).

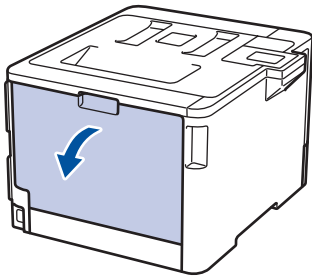

2. Pull down the two gray levers, one on the left side and one on the right side, as shown in the illustration.

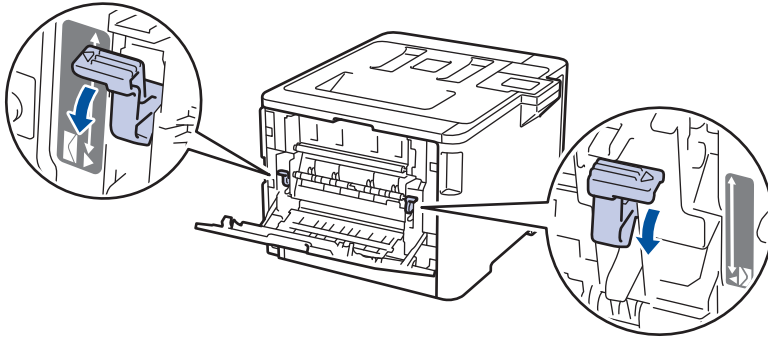

3. On the front of the machine, open the MP tray and lower it gently.

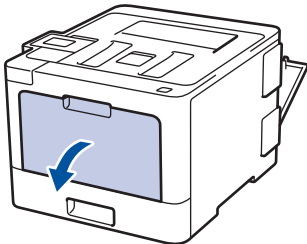

4. Pull out the MP tray support (1) and unfold the flap (2).

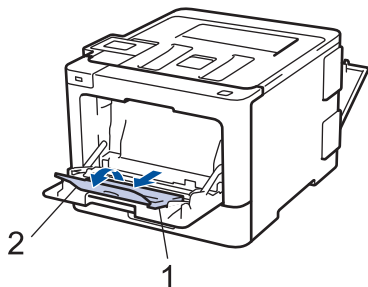

5. Slide the MP tray paper guides to fit the width of the envelopes that you are using.

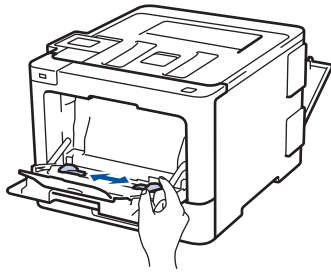

6. Load paper with the printing surface *face up* in the MP tray.

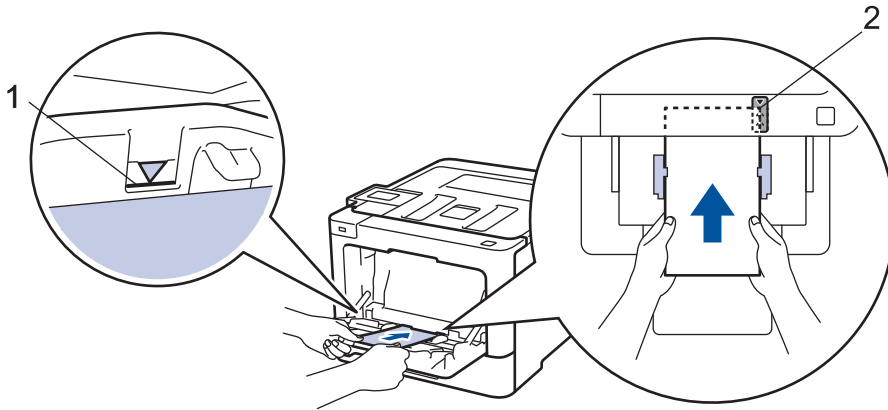

- Load up to 10 envelopes in the MP tray with the printing surface face up. Make sure the envelopes are below the maximum paper mark (1). Loading more than 10 envelopes may cause paper jams.
- Place the paper's leading edge (top of paper) between the ▲ and ▼ arrows (2).

7. Change your print preferences in the Print dialog box before sending the print job from your computer.

Settings	Options for Envelopes
Paper Size	Com-10 DL C5 Monarch
Media Type	Envelopes Env. Thick Env. Thin

- Send your print job to the machine.
- When you have finished printing, return the two gray levers you adjusted in the earlier step back to their original positions.
- Close the back cover (the face up output tray) until it locks in the closed position.



Related Information



- [Load and Print Using the Multi-purpose Tray \(MP Tray\)](#)

Paper Settings

- [Change the Paper Size and Paper Type](#)
- [Change the Check Paper Size Setting](#)

Change the Paper Size and Paper Type

When you change the size and type of the paper you load in the tray, you must change the Paper Size and Paper Type settings on the LCD at the same time.

1. Press  [Settings] > [All Settings] > [General Setup] > [Tray Setting] > [Paper Type].
2. Press ▲ or ▼ to display the paper tray options, and then press the option you want.
3. Press ▲ or ▼ to display the paper type options, and then press the option you want.
4. Press .
5. Press ▲ or ▼ to display the [Paper Size] option.
6. Press ▲ or ▼ to display the paper tray options, and then press the option you want.
7. Press ▲ or ▼ to display the paper size options, and then press the option you want.
8. Press .





Related Information

- [Paper Settings](#)

Change the Check Paper Size Setting

When you turn on your machine's Check Size setting, the machine displays a message when you remove a paper tray or load paper using the MP tray, asking if you changed the paper size and paper type.

The default setting is On.

1. Press  [Settings] > [All Settings] > [General Setup] > [Tray Setting] > [Check Size].
2. Press [On] or [Off].
3. Press .



Related Information

- [Paper Settings](#)
-

Unprintable Area

The measurements in the table below show maximum unprintable areas from the edges of the most commonly-used paper sizes. The measurements may vary depending on the paper size or settings in the application you are using.

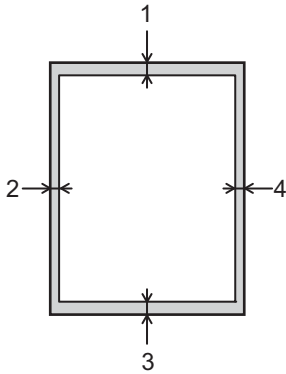

Do not attempt to print into these areas; your output will not reflect anything in these areas.

Usage	Document Size	Top (1) Bottom (3)	Left (2) Right (4)
Print	Letter	0.16 in. (4.23 mm)	0.16 in. (4.23 mm)
	A4	0.16 in. (4.23 mm)	0.16 in. (4.23 mm)
	Legal	0.16 in. (4.23 mm)	0.16 in. (4.23 mm)



Related Information

- [Paper Handling](#)

Recommended Print Media

To get the best print quality, we recommend using the paper listed in the table.

Paper Type	Item
Plain Paper	Xerox Vitality Multipurpose Printer Paper, 20 lb (20 lb = 75 g/m ²)
	Hammermill Laser Print (24 lb = 90 g/m ²)
Recycled Paper	No specific brand recommended
Labels	Avery laser labels white #5160
Envelopes	No specific brand recommended
Glossy Paper	NewPage Futura Laser Gloss 80 lb Text (80 lb = 118 g/m ²)



Related Information

- [Paper Handling](#)
- [Improve the Print Quality](#)

Using Special Paper

Always test paper samples before purchasing them to ensure desirable performance.

- DO NOT use inkjet paper; it may cause a paper jam or damage your machine.
- If you use bond paper, paper with a rough surface, or paper that is wrinkled or creased, the paper may exhibit degraded performance.

Store paper in its original packaging and keep it sealed. Keep the paper flat and away from moisture, direct sunlight and heat.

IMPORTANT

Some types of paper may not perform well or may cause damage to your machine.

DO NOT use paper:

- that is highly textured
- that is extremely smooth or shiny
- that is curled or warped
- that is coated or has a chemical finish
- that is damaged, creased or folded
- that exceeds the recommended weight specification in this guide
- with tabs and staples
- with letterheads using low temperature dyes or thermography
- that is multipart or carbonless
- that is designed for inkjet printing

If you use any of the types of paper listed above, they may damage your machine. This damage is not covered under any Brother warranty or service agreement.



Related Information

- [Paper Handling](#)

Print

- [Print from Your Computer \(Windows®\)](#)
- [Print from Your Computer \(Macintosh\)](#)
- [Cancel a Print Job](#)
- [Test Print](#)

Print from Your Computer (Windows®)

- [Print a Document \(Windows®\)](#)
- [Print Settings \(Windows®\)](#)
- [Secure Print \(Windows®\)](#)
- [Change the Default Print Settings \(Windows®\)](#)
- [Print a Document Using the BR-Script3 Printer Driver \(PostScript® 3™ Language Emulation\) \(Windows®\)](#)
- [Monitor the Status of the Machine from Your Computer \(Windows®\)](#)

Print a Document (Windows®)

1. Select the print command in your application.
2. Select **Brother XXX-XXXX** (where XXXX is the name of your model), and then click the printing properties or preferences button.

The printer driver window appears.

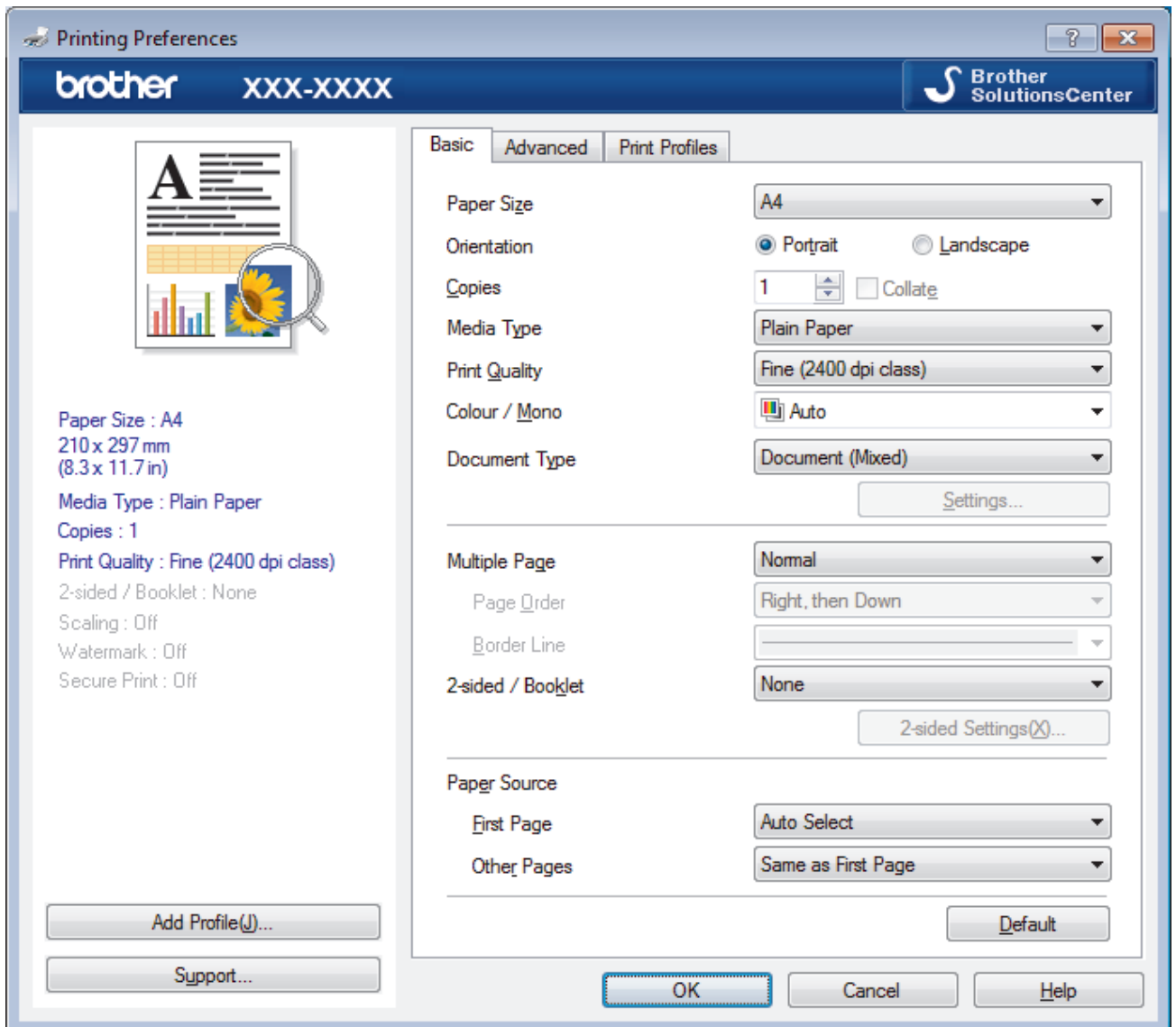

3. Make sure you have loaded the correct size paper in the paper tray.
4. Click the **Paper Size** drop-down list, and then select your paper size.
5. In the **Orientation** field, select the **Portrait** or **Landscape** option to set the orientation of your printout.



If your application contains a similar setting, we recommend that you set the orientation using the application.

6. Type the number of copies (1-999) you want in the **Copies** field.
7. Click the **Media Type** drop-down list, and then select the type of paper you are using.
8. To print multiple pages on a single sheet of paper or print one page of your document on multiple sheets, click the **Multiple Page** drop-down list, and then select your options.
9. Change other printer settings if needed.
10. Click **OK**.
11. Complete your print operation.



Related Information

- [Print from Your Computer \(Windows®\)](#)
- [Print Settings \(Windows®\)](#)

Print Settings (Windows®)

Basic Tab

The screenshot shows the 'Printing Preferences' dialog box for a Brother printer. The 'Basic' tab is active, displaying various settings. On the left, there is a preview of a document with a magnifying glass over a sunflower image. Below the preview, the current settings are listed: Paper Size: A4 (210 x 297 mm / 8.3 x 11.7 in), Media Type: Plain Paper, Copies: 1, Print Quality: Fine (2400 dpi class), 2-sided / Booklet: None, Scaling: Off, Watermark: Off, and Secure Print: Off. The main settings area includes Paper Size (A4), Orientation (Portrait selected), Copies (1), Collate (unchecked), Media Type (Plain Paper), Print Quality (Fine (2400 dpi class)), Colour / Mono (Auto), Document Type (Document (Mixed)), Multiple Page (Normal), Page Order (Right, then Down), Border Line, 2-sided / Booklet (None), Paper Source (First Page: Auto Select, Other Pages: Same as First Page). Buttons for 'Add Profile(J)...', 'Support...', 'Settings...', '2-sided Settings(O)...', and 'Default' are present. At the bottom are 'OK', 'Cancel', and 'Help' buttons.

1. Paper Size

Select the size of the paper you want to use. You can either choose from standard paper sizes or create a custom paper size.

2. Orientation

Select the orientation (portrait or landscape) of your printout.

If your application contains a similar setting, we recommend that you set the orientation using the application.

3. Copies

Type the number of copies (1-999) that you want to print in this field.

Collate

Select this option to print sets of multi-page documents in the original page order. When this option is selected, one complete copy of your document will print, and then reprint according to the number of copies you choose. If this option is not selected, then each page will print according to the number of copies chosen before the next page of the document is printed.

4. Media Type

Select the type of media you want to use. To achieve the best print results, the machine automatically adjusts its print settings according to the selected media type.

5. Print Quality

Select the print resolution you want. Because print quality and speed are related, the higher the quality, the longer it will take to print the document.

6. Color / Mono

Select the Color/Mono settings to use.

NOTE

- The machine's color sensor is very sensitive and may perceive faded black text or an off-white background as color. If you know that your document is black and white and you want to conserve color toner, select **Mono** mode.
- If either the Cyan, Magenta or Yellow toner reaches the end of its life while printing a color document, the print job cannot be completed. Cancel your print job and select to start the print job again in **Mono** mode, as long as Black toner is available.

7. Document Type

Select the type of document you want to print.

Settings button

Specify advanced settings, such as color mode and other settings.

Color Mode

Select the color mode to suit your preference.

Import

To adjust the print configuration of a particular image, click **Settings**. When you have finished adjusting the image parameters, such as brightness and contrast, import those settings as a print configuration file. Use the **Export** option to create a print configuration file from the current settings.

Export

To adjust the print configuration of a particular image, click **Settings**. When you have finished adjusting the image parameters, such as brightness and contrast, export those settings as a print configuration file. Use the **Import** option to load a previously exported configuration file.

Improve Gray Color

Select this option to improve the image quality of shaded areas.

Enhance Black Printing

If a black graphic does not print correctly, select this setting.

Improve Pattern Printing

Select this option to improve the pattern printing if printed fills and patterns are different from the fills and patterns you see on your computer screen.

8. Multiple Page

Select this option to print multiple pages on a single sheet of paper or print one page of your document on multiple sheets.

Page Order

Select the page order when printing multiple pages on a single sheet of paper.

Border Line

Select the type of border to use when printing multiple pages on a single sheet of paper.

9. 2-sided / Booklet

Select this option to print on both sides of the paper or print a document in booklet format using 2-sided printing.

2-sided Settings button

Click this button to select the type of 2-sided binding. Four types of 2-sided bindings are available for each orientation.

10. Paper Source

Select the paper source setting according to your print conditions or purpose.

First Page

Select the paper source to use for printing the first page.

Other Pages

Select the paper source to use for printing the second and subsequent pages.

Advanced Tab

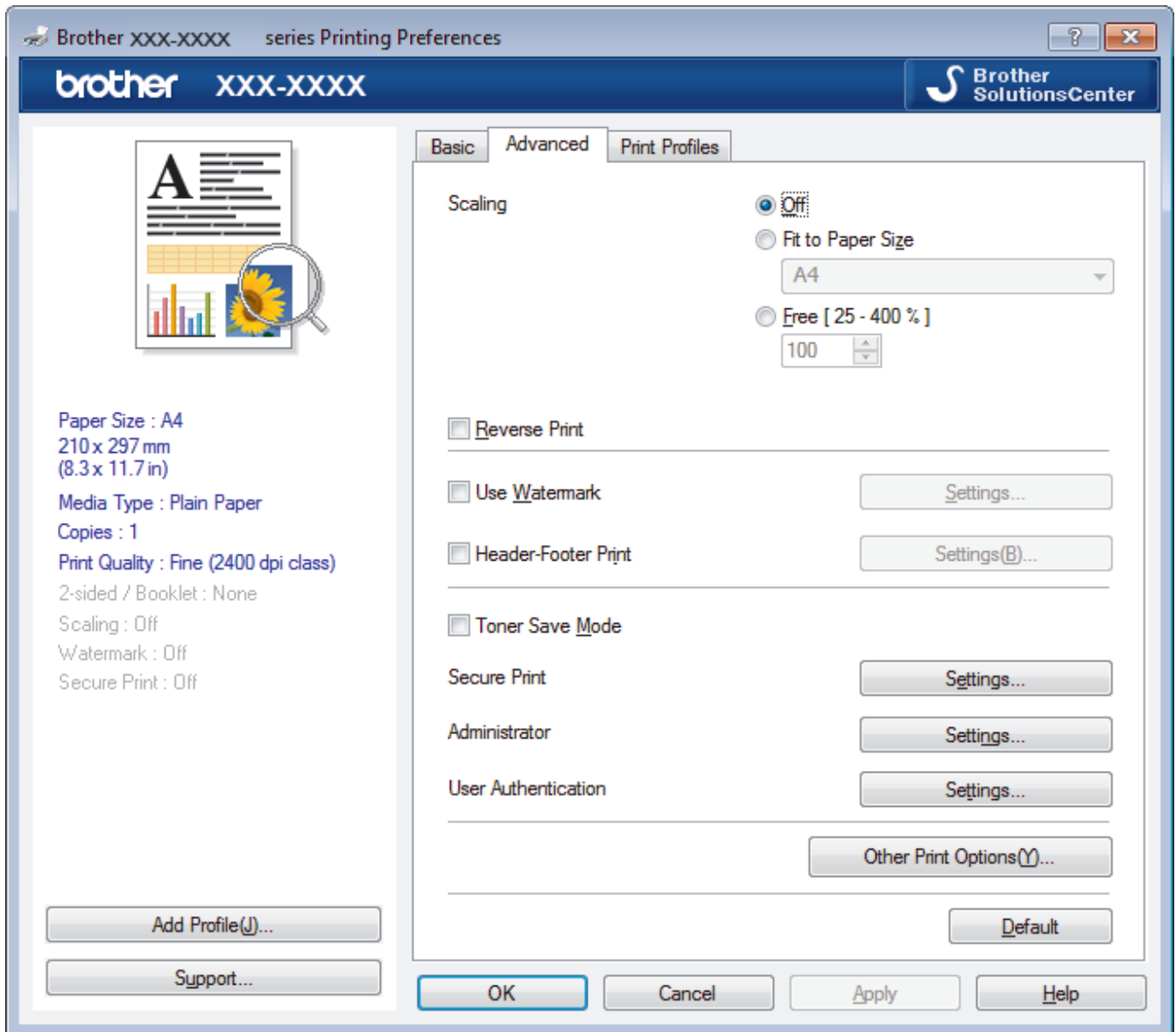

1. Scaling

Select these options to enlarge or reduce the size of the pages in your document.

Fit to Paper Size

Select this option to enlarge or reduce the document pages to fit a specified paper size. When you select this option, select the paper size you want from the drop-down list.

Free

Select this option to enlarge or reduce the document pages manually. When you select this option, type a value into the field.

2. Reverse Print

Select this option to rotate the printed image 180 degrees.

3. Use Watermark

Select this option to print a logo or text on your document as a watermark. Select one of the preset watermarks, add a new watermark, or use an image file you have created.

4. Header-Footer Print

Select this option to print the date, time and PC login user name on the document.

5. Toner Save Mode

Select this feature to conserve toner by using less toner to print documents; printouts appear lighter, but are still legible.

6. Secure Print

This feature ensures that confidential or sensitive documents do not print until you enter a password on the machine's control panel.

7. Administrator

This feature allows you to change the administrator password and restrict various printing functions.

8. User Authentication

This feature allows you to confirm the restrictions for each user.

9. Other Print Options button

Sleep Time

Specify the amount of time that passes before the machine enters Sleep Mode.

Improve Print Output

Select this option to reduce the amount of paper curling and improve the toner fixing.

TrueType Mode

Mode

Select how the fonts are processed for printing.

Use Printer TrueType Fonts(Available only for certain models)

Select whether to use built-in fonts for the font processing.

Eco settings

Select this option to reduce printing noise.



Related Information

- [Print from Your Computer \(Windows®\)](#)
 - [Print a Document \(Windows®\)](#)
-

Secure Print (Windows®)

Use Secure Print to ensure that confidential or sensitive documents do not print until you enter a password on the machine's control panel.

- The secure data is deleted from the machine when you turn off the machine.

1. Select the print command in your application.
2. Select **Brother XXX-XXXX** (where XXXX is the name of your model), and then click the printing properties or preferences button.
The printer driver window appears.
3. Click the **Advanced** tab.
4. Click the **Settings** button in the **Secure Print** field.
5. Select the **Secure Print** check box.
6. Type your four-digit password in the **Password** field.



You must set a separate password for each document.

7. Type the **User Name** and **Job Name** in the text field, if needed.
8. Click **OK**, to close the **Secure Print Settings** window.
9. Click **OK**.
10. Complete your print operation.
11. On the machine's control panel, press [Functions].
12. Press [Secure Print].
13. Press ▲ or ▼ to display user names, and then press your user name.
The LCD displays the list of secured jobs for your name.
14. Press ▲ or ▼ to display the print job, and then press it.
15. Enter your four-digit password, and then press [OK].
16. Enter the number of copies you want.
17. Press [Start].
The machine prints the data.

After you have printed the secured data, it will be cleared from the machine's memory.



Related Information

- [Print from Your Computer \(Windows®\)](#)

Change the Default Print Settings (Windows®)

When you change an application's print settings, the changes only apply to documents printed with that application. To change print settings for all Windows® applications, you must configure the printer driver properties.

1. Do one of the following:

- For Windows Server® 2008

Click  (**Start**) > **Control Panel** > **Hardware and Sound** > **Printers**.

- For Windows® 7 and Windows Server® 2008 R2

Click  (**Start**) > **Devices and Printers**.

- For Windows® 8

Move your mouse to the lower right corner of your desktop. When the menu bar appears, click **Settings**, and then click **Control Panel**. In the **Hardware and Sound** group, click **View devices and printers**.

- For Windows® 10 and Windows Server® 2016

Click  > **Windows System** > **Control Panel**. In the **Hardware and Sound** group, click **View devices and printers**.

- For Windows Server® 2012

Move your mouse to the lower right corner of your desktop. When the menu bar appears, click **Settings**, and then click **Control Panel**. In the **Hardware** group, click **View devices and printers**.

- For Windows Server® 2012 R2

Click **Control Panel** on the **Start** screen. In the **Hardware** group, click **View devices and printers**.

2. Right-click the **Brother XXX-XXXX** icon (where XXXX is your model name), and then select **Printer properties**. If printer driver options appear, select your printer driver.

3. Click the **General** tab, and then click the **Printing Preferences...** or **Preferences...** button.

The printer driver dialog box appears.



- To configure the tray settings, click the **Device Settings** tab.
- To change the printer port, click the **Ports** tab.

4. Select the print settings you want to use as defaults for all of your Windows® programs.

5. Click **OK**.

6. Close the printer properties dialog box.





Related Information

- [Print from Your Computer \(Windows®\)](#)
- [Configure the Optional Tray Settings \(Windows®\)](#)

Configure the Optional Tray Settings (Windows®)

Access your machine's Properties to auto-detect your machine's Optional Tray and serial number.

The printer driver automatically detects the Optional Tray during the driver installation. If you added the Optional Tray after the driver installation, follow these steps:

1. Do one of the following:
 - For Windows Server® 2008
Click  (**Start**) > **Control Panel** > **Hardware and Sound** > **Printers**.
 - For Windows® 7 and Windows Server® 2008 R2
Click  (**Start**) > **Devices and Printers**.
 - For Windows® 8
Move your mouse to the lower right corner of your desktop. When the menu bar appears, click **Settings**, and then click **Control Panel**. In the **Hardware and Sound** group, click **View devices and printers**.
 - For Windows® 10 and Windows Server® 2016
Click  > **Windows System** > **Control Panel**. In the **Hardware and Sound** group, click **View devices and printers**.
 - For Windows Server® 2012
Move your mouse to the lower right corner of your desktop. When the menu bar appears, click **Settings**, and then click **Control Panel**. In the **Hardware** group, click **View devices and printers**.
 - For Windows Server® 2012 R2
Click **Control Panel** on the **Start** screen. In the **Hardware** group, click **View devices and printers**.
2. Right-click the **Brother XXX-XXXX** icon (where XXXX is your model name), and then select **Printer properties**. If printer driver options appear, select your printer driver.
3. Click the **Device Settings** tab.
4. Click the **Auto Detect** button.
The Optional Tray and the machine's serial number are automatically detected.
5. Click the **Apply** button.
6. Close the printer properties dialog box.

The **Auto Detect** function is not available under the following machine conditions:

- The machine power switch is off.
- The machine is in a network shared environment.
- The cable is not connected to the machine correctly.

Related Information

- [Change the Default Print Settings \(Windows®\)](#)

Print a Document Using the BR-Script3 Printer Driver (PostScript® 3™ Language Emulation) (Windows®)

The BR-Script3 printer driver lets you print PostScript® data more clearly.

To install the PS driver (BR-Script3 printer driver), launch the Brother installation disc, select **Custom** in the Select Machine section, and then select the **PS Driver** check box.

1. Select the print command in your application.
2. Select **Brother XXX-XXXX BR-Script3** (where XXXX is the name of your model), and then click the printing properties or preferences button.

The printer driver window appears.

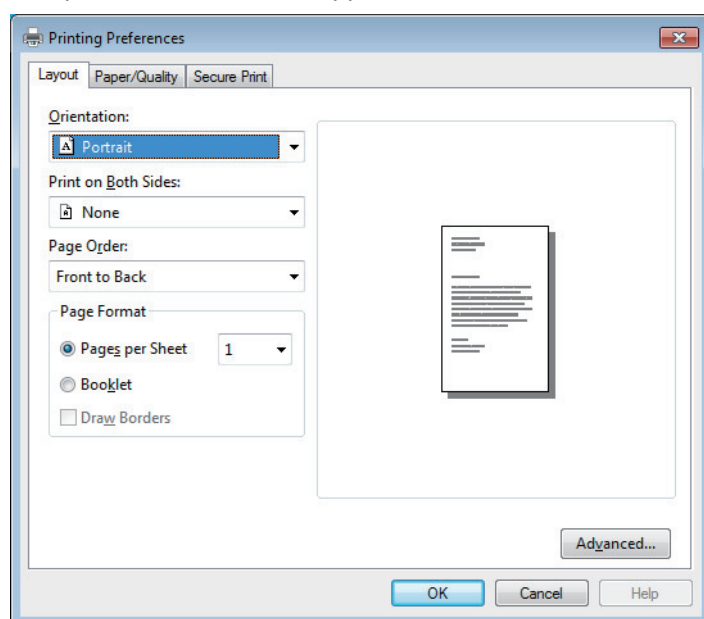

3. Click the **Layout**, **Paper/Quality**, or **Secure Print** tab to change basic print settings.
Click the **Layout** or **Paper/Quality** tab, and then click the **Advanced...** button to change advanced print settings.
4. Click **OK**.
5. Complete your print operation.

✓ Related Information

- [Print from Your Computer \(Windows®\)](#)

Monitor the Status of the Machine from Your Computer (Windows®)

The Status Monitor utility is a configurable software tool for monitoring the status of one or more devices, allowing you to get immediate notification of errors.

- Do one of the following:

- Double-click the  icon in the task tray.
- (Windows® 7, Windows Server® 2008 and Windows Server® 2008 R2)



Click  (**Start**) > **All Programs** > **Brother** > **Brother Utilities**.

Click the drop-down list and select your model name (if not already selected). Click **Tools** in the left navigation bar, and then click **Status Monitor**.

- (Windows® 8 and Windows Server® 2012)

Click  (**Brother Utilities**), and then click the drop-down list and select your model name (if not already selected). Click **Tools** in the left navigation bar, and then click **Status Monitor**.

- (Windows® 8.1 and Windows Server® 2012 R2)

Move your mouse to the lower left corner of the **Start** screen and click  (if you are using a touch-based device, swipe up from bottom of the **Start** screen to bring up the **Apps** screen). When the **Apps** screen appears, tap or click  (**Brother Utilities**), and then click the drop-down list and select your model name (if not already selected). Click **Tools** in the left navigation bar, and then click **Status Monitor**.

- (Windows® 10 and Windows Server® 2016)

Click  **Brother** > **Brother Utilities**.

Click the drop-down list and select your model name (if not already selected). Click **Tools** in the left navigation bar, and then click **Status Monitor**.

Troubleshooting

Click the **Troubleshooting** button to access the troubleshooting website.

Visit the Genuine Supplies website

Click the **Visit the Genuine Supplies website** button for more information on Brother genuine supplies.



Related Information

- [Print from Your Computer \(Windows®\)](#)
- [Printing Problems](#)
- [Calibrate Color Output](#)

Print from Your Computer (Macintosh)

- [Print a Document \(Macintosh\)](#)
- [Print Options \(Macintosh\)](#)
- [Secure Print \(Macintosh\)](#)
- [Print a Document Using the BR-Script3 Printer Driver \(PostScript® 3™ language emulation\) \(Macintosh\)](#)
- [Monitor the Status of the Machine from Your Computer \(Macintosh\)](#)

Print a Document (Macintosh)

1. Make sure you have loaded the correct size paper in the paper tray.
2. From an application, such as Apple TextEdit, click the **File** menu, and then select **Print**.
3. Select **Brother XXX-XXXX** (where XXXX is your model name).
4. Type the number of copies you want in the **Copies** field.
5. Click the **Paper Size** pop-up menu, and then select your paper size.
6. Select the **Orientation** option that matches the way you want the document to print.
7. Click the application pop-up menu, and then select **Print Settings**.
The **Print Settings** options appear.
8. Click the **Media Type** pop-up menu, and then select the type of paper you are using.
9. Change other printer settings, if needed.
10. Click **Print**.



Related Information

- [Print from Your Computer \(Macintosh\)](#)
 - [Print Options \(Macintosh\)](#)
-



Print Options (Macintosh)

Page Setup

Settings: **Page Attributes**

Format For: **XXX-XXXX**
Brother XXX-XXXX CUPS

Paper Size: **A4**
210 by 297 mm

Orientation:  

Scale: **100** %

 **Cancel** **OK**

1. Paper Size

Select the size of the paper you want to use. You can either choose from standard paper sizes or create a custom paper size.

2. Orientation

Select the orientation (portrait or landscape) of your printout.

If your application contains a similar setting, we recommend that you set the orientation using the application.

3. Scale

Type a value into the field to enlarge or reduce the pages in your document to fit the selected paper size.

Layout

Printer: XXX-XXXX

Presets: Default Settings

Copies: 1 Two-Sided

Pages: All
 From: 1 to: 1

Paper Size: A4 210 by 297 mm

Orientation: Portrait Landscape

Layout: Layout

Pages per Sheet: 1

Layout Direction: Z S M N

Border: None

Two-Sided: Off

Reverse page orientation
 Flip horizontally

? PDF Hide Details Cancel Print

1. Pages per Sheet

Select the number of pages to print on a single sheet of paper.

2. Layout Direction

Select the page order when printing multiple pages on a single sheet of paper.

3. Border

Select the type of border to use when printing multiple pages on a single sheet of paper.

4. Two-Sided

Select whether to print on both sides of the paper.

5. Reverse page orientation

Select this option to rotate the printed image 180 degrees.

6. Flip horizontally

Select this option to reverse the printed image on the page horizontally from left to right.

Paper Handling

Printer: XXX-XXXX

Presets: Default Settings

Copies: 1 Two-Sided

Pages: All
 From: 1 to: 1

Paper Size: A4 210 by 297 mm

Orientation:

Paper Handling

Collate pages

Pages to Print: All pages

Page Order: Automatic

Scale to fit paper size

Destination Paper Size: Suggested Paper: A4

Scale down only

1 of 1

PDF Hide Details Cancel Print

1. Collate pages

Select this option to print sets of multi-page documents in the original page order. When this option is selected, one complete copy of your document will print, and then reprint according to the number of copies you choose. If this option is not selected, then each page will print according to the number of copies chosen before the next page of the document is printed.

2. Pages to Print

Select which pages you want to print (even pages or odd pages).

3. Page Order

Select the page order.

4. Scale to fit paper size

Select this option to enlarge or reduce the pages in your document to fit the selected paper size.

5. Destination Paper Size

Select the paper size to print on.

6. Scale down only

Select this option if you want to reduce the pages in your document when they are too large for the selected paper size. If this option is selected and the document is formatted for a paper size that is smaller than the paper size you are using, the document will be printed at its original size.

Print Settings

Printer: XXX-XXXX

Presets: Default Settings

Copies: 1 Two-Sided

Pages: All
 From: 1 to: 1

Paper Size: A4 210 by 297 mm

Orientation: Portrait Landscape

Print Settings

Media Type: Plain Paper

Print Quality: Fine

Color / Mono: Auto

Paper Source: Auto Select

► Advanced

? PDF Hide Details Cancel Print

1. Media Type

Select the type of media you want to use. To achieve the best print results, the machine automatically adjusts its print settings according to the selected media type.

2. Print Quality

Select the print resolution you want. Because print quality and speed are related, the higher the quality, the longer it will take to print the document.

3. Color / Mono

Select the Color/Mono settings to use.

NOTE

- The machine's color sensor is very sensitive and may perceive faded black text or an off-white background as color. If you know that your document is black and white and you want to conserve color toner, select **Mono** mode.
- If either the Cyan, Magenta or Yellow toner reaches the end of its life while printing a color document, the print job cannot be completed. Cancel your print job and select to start the print job again in **Mono** mode, as long as Black toner is available.

4. Paper Source

Select the paper source setting according to your print conditions or purpose.

5. Advanced

Toner Save Mode

Select this feature to conserve toner by using less toner to print documents; printouts appear lighter, but are still legible.

Improve Print Output

Select this option to reduce the amount of paper curling and improve the toner fixing.

Sleep Time

Specify the amount of time that passes before the machine enters Sleep Mode.

Quiet Mode

Select this option to reduce printing noise.

Other Print Options

Skip Blank Page

Select this option to allow the printer driver to automatically detect blank pages and exclude them from printing.

Color Settings

Printer: XXX-XXXX

Presets: Default Settings

Copies: 1 Two-Sided

Pages: All
 From: 1 to: 1

Paper Size: A4 210 by 297 mm

Orientation: Portrait Landscape

Color Settings

Color Mode: Normal
 Vivid
 None

▼ Advanced Color Settings

Brightness	0	<input type="range"/>
Contrast	0	<input type="range"/>
Red	0	<input type="range"/>
Green	0	<input type="range"/>
Blue	0	<input type="range"/>
Saturation	0	<input type="range"/>

Improve Gray Color
 Enhance Black Printing

? PDF Hide Details Cancel Print

1. Color Mode

Select the color mode to suit your preference.

2. Advanced Color Settings

Click the disclosure triangle to select the Color Enhancement feature. This feature analyzes your image to improve its sharpness, white balance and color density. This process may take several minutes depending on the size of the image and the specifications of your computer.

Secure Print

Printer: XXX-XXXX

Presets: Default Settings

Copies: 1 Two-Sided

Pages: All
 From: 1 to: 1

Paper Size: A4 210 by 297 mm

Orientation:

Secure Print

Secure Print

User Name :

Job Name :

Password :

? PDF Hide Details Cancel Print

1. Secure Print

This feature ensures that confidential or sensitive documents do not print until you enter a password on the machine's control panel.

✓ Related Information

- [Print from Your Computer \(Macintosh\)](#)
- [Print a Document \(Macintosh\)](#)

Secure Print (Macintosh)

Use Secure Print to ensure that confidential or sensitive documents do not print until you enter a password on the machine's control panel.

- The secure data is deleted from the machine when you turn off the machine.

1. From an application, such as Apple TextEdit, click the **File** menu, and then select **Print**.
2. Select **Brother XXX-XXXX** (where XXXX is your model name).
3. Click the application pop-up menu, and then select the **Secure Print** option. The **Secure Print** options appear.
4. Select the **Secure Print** check box.
5. Type your user name, job name and a four-digit password.
6. Click **Print**.
7. Complete your print operation.
8. On the machine's control panel, press [Functions].
9. Press [Secure Print].
10. Press ▲ or ▼ to display user names, and then press your user name.
The LCD displays the list of secured jobs for your name.
11. Press ▲ or ▼ to display the print job, and then press it.
12. Enter your four-digit password, and then press [OK].
13. Enter the number of copies you want.
14. Press [Start].

After you have printed the secured data, it will be cleared from the machine's memory.



Related Information

- [Print from Your Computer \(Macintosh\)](#)

Print a Document Using the BR-Script3 Printer Driver (PostScript® 3™ language emulation) (Macintosh)

The BR-Script3 printer driver lets you print PostScript® data more clearly.

- Go to your model's **Downloads** page on the Brother Solutions Center at support.brother.com to download the PS driver (BR-Script3 printer driver).
- Make sure you have added the BR-Script3 printer driver from **Print & Scan** or **Printers & Scanners** in the **System Preferences** list on your Macintosh.

1. Make sure you have loaded the correct size paper in the paper tray.
2. From an application, such as Apple TextEdit, click the **File** menu, and then select **Print**.
3. Select your machine.
4. Type the number of copies you want in the **Copies** field.
5. Click the **Paper Size** pop-up menu, and then select your paper size.
6. Select the **Orientation** option that matches the way you want the document to print.
7. Click the print options pop-up menu, and then click **Printer Features**.
The **Printer Features** options appear.
8. Click the **Print Quality** pop-up menu, and then select the print quality.
9. Click the **Media Type** pop-up menu, and then select the type of paper you are using.
10. Select the **Auto**, **Color**, or **Mono** option for the **Color / Mono** print setting.
11. Change other printer settings, if needed.
12. Click **Print**.



Related Information

- [Print from Your Computer \(Macintosh\)](#)

Monitor the Status of the Machine from Your Computer (Macintosh)

The Status Monitor utility is a configurable software tool for monitoring the status of a device, allowing you to get immediate notification of error messages, such as paper empty or paper jam, at preset update intervals. You can also access Web Based Management.

1. Click the **System Preferences** menu, select **Print & Scan** or **Printers & Scanners**, and then select your machine.
2. Click the **Options & Supplies** button.
3. Click the **Utility** tab, and then click the **Open Printer Utility** button.

Status Monitor starts.

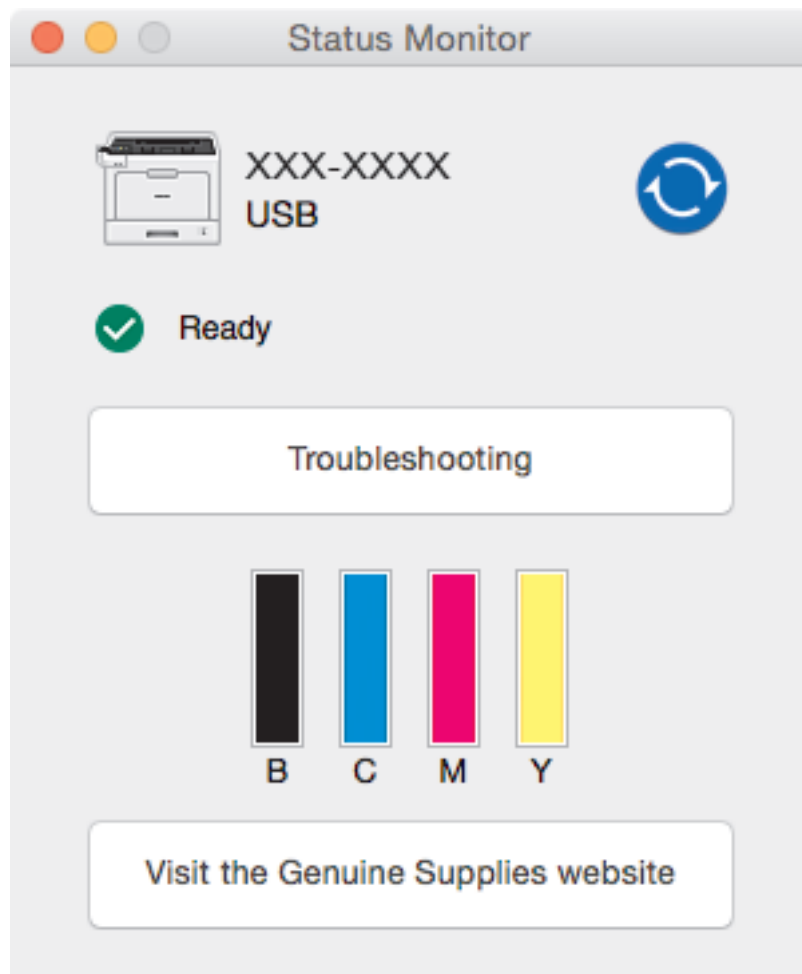

Troubleshooting

Click the **Troubleshooting** button to access the troubleshooting website.

Visit the Genuine Supplies website

Click the **Visit the Genuine Supplies website** button for more information on Brother genuine supplies.

Updating the machine's status

To view the latest machine status while the **Status Monitor** window is open, click the  icon. You can set the interval at which the software updates machine status information. Click **Brother Status Monitor** in the menu bar, and then select **Preferences**.

Web Based Management (Network Connection Only)

Access the Web Based Management System by clicking the machine icon on the **Status Monitor** screen. You can use a standard Web Browser to manage your machine using HTTP (Hyper Text Transfer Protocol).



Related Information

- [Print from Your Computer \(Macintosh\)](#)
 - [Printing Problems](#)
 - [Calibrate Color Output](#)
-

Cancel a Print Job

1. Press .



To cancel multiple print jobs, press and hold  for four seconds.





Related Information

- [Print](#)
- [Printing Problems](#)

Test Print

If there are problems with print quality, follow these instructions to do a test print:

1. Press  [Settings] > [All Settings] > [Printer] > [Print Options] > [Test Print].
2. Press [Yes].
3. Press .



Related Information

- [Print](#)
 - [Improve the Print Quality](#)
-

Print Data Directly from a USB Flash Drive

You can print photos directly from digital camera media or a USB flash drive.

Supported file types are PDF, JPEG, TIFF, XPS, and PRN.

- [Compatible USB Flash Drives](#)
- [Print Data Directly from a USB Flash Drive or Digital Camera Supporting Mass Storage](#)
- [Create a PRN File for Direct Printing \(Windows®\)](#)

Compatible USB Flash Drives

IMPORTANT

The USB direct interface supports only USB flash drives and digital cameras that use the USB mass storage standard. Other USB devices are not supported.

Compatible USB Flash Drives	
USB Class	USB Mass Storage Class
USB Mass Storage Sub Class	SCSI or SFF-8070i
Transfer protocol	Bulk transfer Only
Format ¹	FAT12/FAT16/FAT32/exFAT
Sector size	Max. 4096 Byte
Encryption	Encrypted devices are not supported.



Related Information

- [Print Data Directly from a USB Flash Drive](#)

¹ NTFS format is not supported.

Print Data Directly from a USB Flash Drive or Digital Camera Supporting Mass Storage

- Make sure your digital camera is turned on.
- Your digital camera must be switched from PictBridge mode to mass storage mode.

IMPORTANT

To prevent damage to your machine, DO NOT connect any device other than a digital camera or USB flash drive to the USB direct interface.

USB port location (Front View)

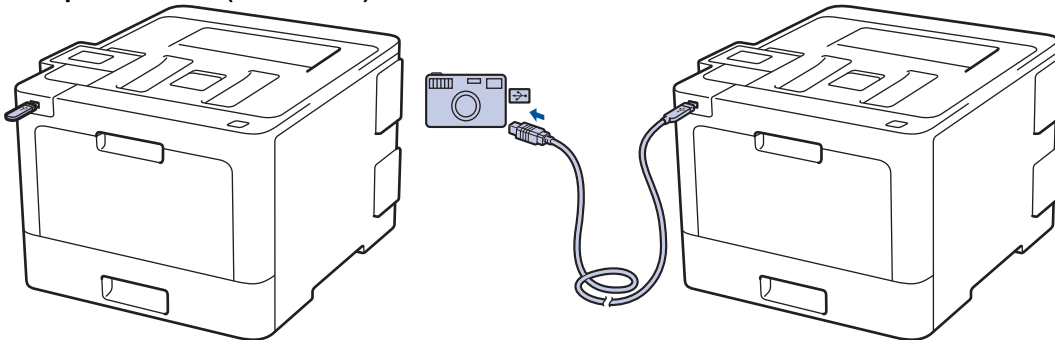

USB port location (Back View)

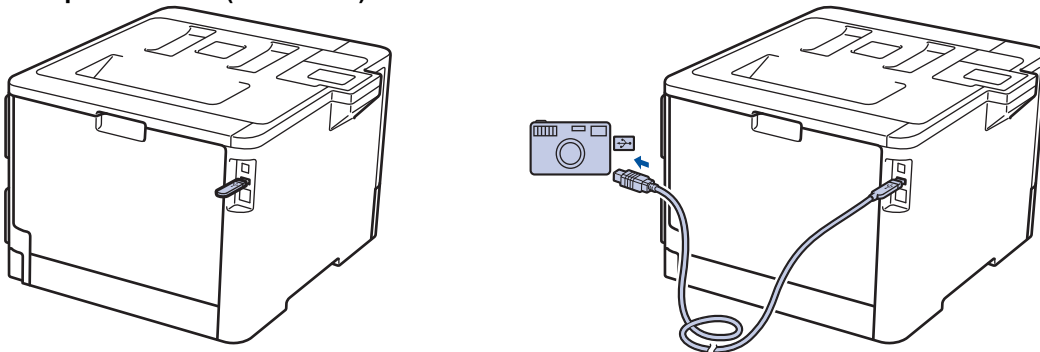

1. Connect your USB flash drive or digital camera to the USB direct interface. The LCD displays the [Checking Image] message.



- If an error occurs, the USB menu does not appear on the LCD.
- When the machine is in Deep Sleep mode, the LCD does not display any information even if you connect a USB flash drive to the USB direct interface. Press any button on the control panel to wake up the machine.
- If your machine has been set to Secure Function Lock On, you may not be able to access Direct Print.
- If the machine prompts you to choose the USB port, select it on the Touchscreen.

2. Press ▲ or ▼ to select the file you want, and then press it.



To print an index of the files, press  [Index Print] on the Touchscreen. Press [Black Start] or [Color Start] to print the data.

3. Do one of the following:

- To change the settings, press [Print Settings]. Go to the next step.

-
- If you want to use the default settings, enter the number of copies, and then press [Black Start] or [Color Start].

4. Select the print settings you want to change:

- [Paper Type]
- [Paper Size]
- [Multiple Page]
- [Orientation]
- [2-sided]
- [Collate]
- [Tray Use]
- [Print Quality]
- [PDF Option]



Depending on the file type, some of these settings may not appear.

5. Press [OK].
6. Enter the number of copies you want.
7. Press [Black Start] or [Color Start] to print the data.
8. Press .

IMPORTANT

DO NOT remove the USB flash drive or digital camera from the USB direct interface until the machine has finished printing.



Related Information

- [Print Data Directly from a USB Flash Drive](#)
-

Create a PRN File for Direct Printing (Windows®)

These instructions may vary depending on your print application and operating system.

1. Select the print command in your application.
2. Select your model, and then select the print to file option.
3. Complete your print operation.
4. Enter the required information to save the file.



If the computer prompts you to enter a file name only, you can also specify the folder where you want to save the file by typing the directory name (for example: C:\Temp\FileName.prn).

If a USB flash drive is connected to your computer, you can save the file directly to the USB flash drive.



Related Information

- [Print Data Directly from a USB Flash Drive](#)

Network

- [Supported Basic Network Features](#)
- [Network Management Software and Utilities](#)
- [Additional Methods of Configuring Your Brother Machine for a Wireless Network](#)
- [Advanced Network Features](#)
- [Technical Information for Advanced Users](#)

Supported Basic Network Features

The print server supports various features depending on the operating system. Use this table to see which network features and connections are supported by each operating system.

Operating Systems	Windows® 7 Windows® 8 Windows® 10	Windows Server® 2008/2012/2012 R2/2016	macOS v10.10.5 macOS v10.11.x macOS v10.12
Printing	Yes	Yes	Yes
BRAdmin Light	Yes	Yes	
BRAdmin Professional 3	Yes	Yes	
Web Based Management	Yes	Yes	Yes
Status Monitor	Yes		Yes
Driver Deployment Wizard	Yes	Yes	
Vertical Pairing	Yes		



- Go to your model's **Downloads** page on the Brother Solutions Center at support.brother.com to download the latest version of Brother's BRAdmin Light.
- Go to your model's **Downloads** page on the Brother Solutions Center at support.brother.com to download the latest version of Brother's BRAdmin Professional 3 utility.



Related Information

- [Network](#)

Network Management Software and Utilities

Configure and change your Brother machine's network settings using a management utility.

- [Learn about Network Management Software and Utilities](#)
- [Change Machine Settings from Your Computer](#)
- [Change Machine Settings Using Web Based Management](#)

Learn about Network Management Software and Utilities

Web Based Management

Web Based Management is a utility that uses a standard web browser to manage your machine using the Hyper Text Transfer Protocol (HTTP) or Hyper Text Transfer Protocol over Secure Socket Layer (HTTPS). Type your machine's IP address into your web browser to access and change your print server settings.

BRAdmin Light (Windows®)

BRAdmin Light is a utility for the initial setup of Brother network-connected devices. This utility can search for Brother products on your network, view the status and configure the basic network settings, such as IP address.

Go to your model's **Downloads** page on the Brother Solutions Center at support.brother.com to download BRAdmin Light.



- If using Windows® Firewall, or the firewall function of an anti-spyware or antivirus application, temporarily disable them. When you are sure you can print, configure the software settings following the instructions.

BRAdmin Professional 3 (Windows®)

BRAdmin Professional 3 is a utility for more advanced management of network-connected Brother devices. This utility can search for Brother products on your network and view the device status from an easy-to-read Windows® Explorer-style screen that changes color to identify the status of each device. You can configure network and device settings, and update device firmware from a Windows® computer on your LAN. BRAdmin Professional 3 can also log activity of Brother devices on your network and export the log data. For users who want to monitor locally-connected machines, install the Print Auditor Client software on the client computer. This utility allows you to use BRAdmin Professional 3 to monitor machines that are connected to a client computer via the USB interface.



- Go to your model's **Downloads** page on the Brother Solutions Center at support.brother.com to download the latest version of Brother's BRAdmin Professional 3 utility.
- Node name: The node name appears in the current BRAdmin Professional 3 window. The default node name is "BRNxxxxxxxxxxxx" for a wired network or "BRWxxxxxxxxxxxx" for a wireless network (where "xxxxxxxxxxxx" is your machine's MAC Address / Ethernet address).
- If using Windows® Firewall, or the firewall function of an anti-spyware or antivirus application, temporarily disable them. When you are sure you can print, configure the software settings following the instructions.



Related Information

- [Network Management Software and Utilities](#)

Additional Methods of Configuring Your Brother Machine for a Wireless Network

To connect your machine to your wireless network, we recommend using the Brother installation disc.

- [Before Configuring Your Brother Machine for a Wireless Network](#)
- [Configure Your Machine for a Wireless Network](#)
- [Configure Your Machine for a Wireless Network Using the One Push Method of Wi-Fi Protected Setup™ \(WPS\)](#)
- [Configure Your Machine for a Wireless Network Using the PIN Method of Wi-Fi Protected Setup™ \(WPS\)](#)
- [Configure Your Machine for a Wireless Network Using the Machine's Control Panel Setup Wizard](#)
- [Configure Your Machine for a Wireless Network When the SSID Is Not Broadcast](#)
- [Configure Your Machine for an Enterprise Wireless Network](#)
- [Use Wi-Fi Direct®](#)

Before Configuring Your Brother Machine for a Wireless Network

Before attempting to configure a wireless network, confirm the following:

- If you are using an enterprise wireless network, you must know the User ID and Password.
- To achieve optimum results with normal everyday document printing, place the Brother machine as close to the wireless LAN access point/router as possible with minimal obstructions. Large objects and walls between the two devices and interference from other electronic devices can affect the data transfer speed of your documents.

Due to these factors, wireless may not be the best method of connection for all types of documents and applications. If you are printing large files, such as multi-page documents with mixed text and large graphics, you may want to consider selecting wired Ethernet for faster data transfer (supported models only), or USB for the fastest throughput speed.

- Although the Brother machine can be used in both a wired and wireless network (supported models only), only one connection method can be used at a time. However, a wireless network connection and Wi-Fi Direct connection, or a wired network connection (supported models only) and Wi-Fi Direct connection can be used at the same time.



If you do not know the security information, please consult the router manufacturer, your system administrator, or your Internet provider.



Related Information

- [Additional Methods of Configuring Your Brother Machine for a Wireless Network](#)

Configure Your Machine for a Wireless Network

1. Turn on your computer and insert the Brother installation disc into your computer.
 - For Windows®, follow these instructions:
 - For Macintosh, click **Driver Download** to go to the Brother Solutions Center. Follow the on-screen instructions to install printer drivers.
2. The opening screen appears automatically.
Choose your language, and then follow the on-screen instructions.



If the Brother screen does not appear, do the following:

- (Windows® 7)
Go to **Computer**. Double-click the CD/DVD icon, and then double-click **start.exe**.
- (Windows® 8 and Windows® 10)
Click the  (**File Explorer**) icon on the taskbar, and then go to **Computer (This PC)**. Double-click the CD/DVD icon, and then double-click **start.exe**.
- If the **User Account Control** screen appears, click **Yes**.

3. Choose **Wireless Network Connection (Wi-Fi)**, and then click **Next**.
4. Follow the on-screen instructions.

After you have completed the wireless setup, the installer program walks you through installing the drivers. Click **Next** in the installation dialog box and follow the on-screen instructions.



Related Information

- [Additional Methods of Configuring Your Brother Machine for a Wireless Network](#)

Configure Your Machine for a Wireless Network Using the One Push Method of Wi-Fi Protected Setup™ (WPS)

If your wireless access point/router supports WPS (PBC: Push Button Configuration), you can use WPS from your machine's control panel menu to configure your wireless network settings.



Routers or access points that support WPS are marked with this symbol:



1. Press  [Settings] > [All Settings] > [Network] > [WLAN] > [WPS].
2. When [Enable WLAN?] appears, press [Yes].
This will start the wireless setup wizard. To cancel, press [No].
3. When the Touchscreen displays [Start WPS on your wireless access point/router, then press [OK].], press the WPS button on your wireless access point/router. Then press [OK] on your machine. Your machine will automatically detect your wireless access point/router and try to connect to your wireless network.

If your wireless device is connected successfully, the machine's LCD displays [Connected].

You have completed the wireless network setup. To install drivers and software necessary for operating your device, insert the Brother installation disc into your computer or go to your model's **Downloads** page on the Brother Solutions Center at support.brother.com.



Related Information

- [Additional Methods of Configuring Your Brother Machine for a Wireless Network](#)
- [Wireless LAN Report Error Codes](#)

Configure Your Machine for a Wireless Network Using the PIN Method of Wi-Fi Protected Setup™ (WPS)

If your wireless LAN access point/router supports WPS, you can use the Personal Identification Number (PIN) Method to configure your wireless network settings.

The PIN Method is one of the connection methods developed by the Wi-Fi Alliance®. By submitting a PIN created by an Enrollee (your machine) to the Registrar (a device that manages the wireless LAN), you can set up the wireless network and security settings. For more information on how to access WPS mode, see the instructions provided with your wireless access point/router.

Type A

Connection when the wireless LAN access point/router (1) doubles as the Registrar:

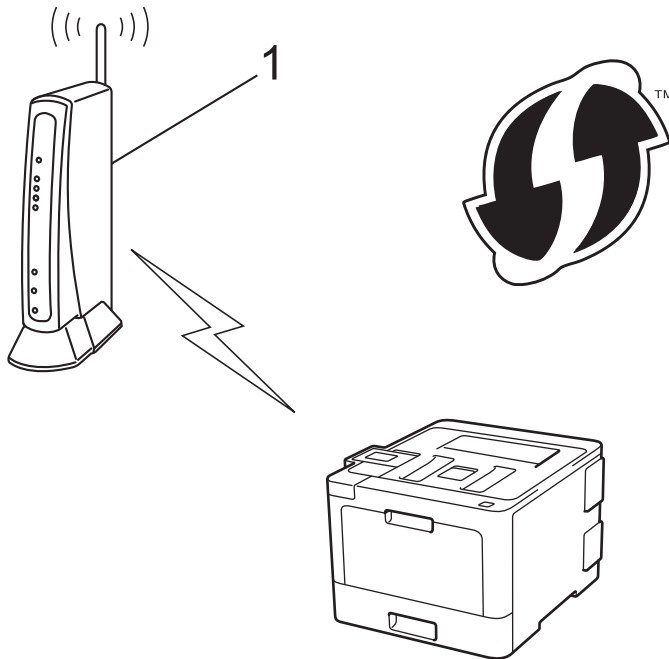

Type B

Connection when another device (2), such as a computer, is used as the Registrar:

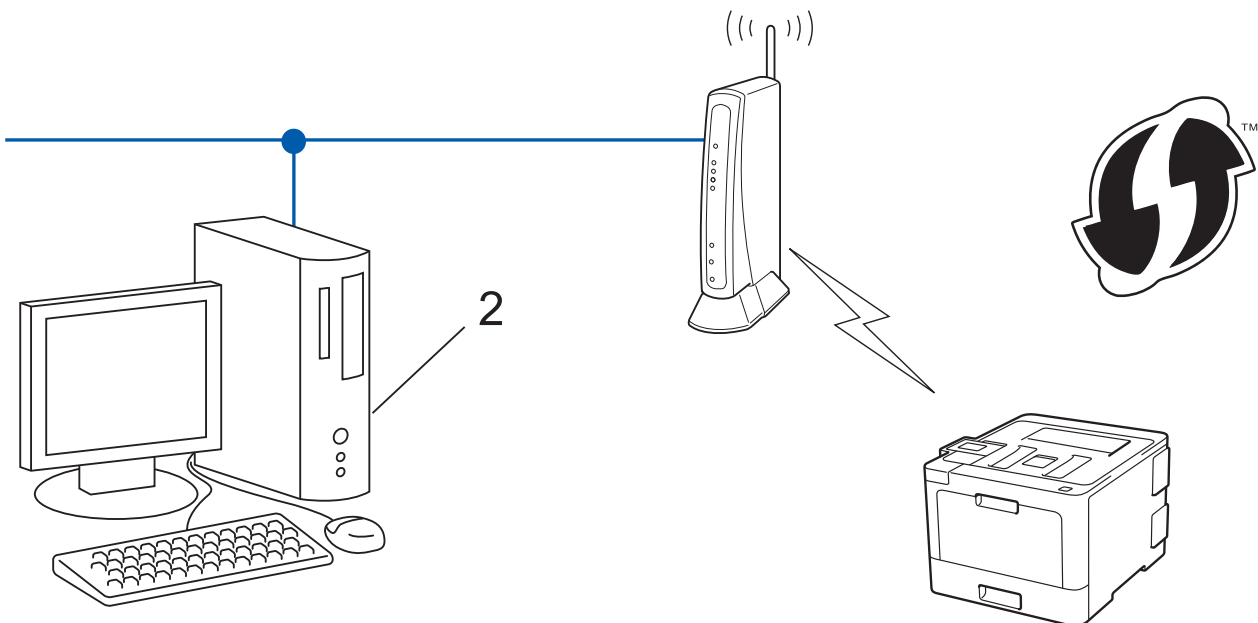

 Routers or access points that support WPS are marked with this symbol:



1. Press  [Settings] > [All Settings] > [Network] > [WLAN] > [WPS w/ PIN Code].
2. When [Enable WLAN?] appears, press [Yes].
This will start the wireless setup wizard. To cancel, press [No].
3. The LCD displays an eight-digit PIN and the machine starts searching for a wireless LAN access point/router.
4. Using a computer connected to the network, in your browser's address bar, type the IP address of the device you are using as the Registrar. (For example: <http://192.168.1.2>)
5. Go to the WPS settings page and type the PIN, and then follow the on-screen instructions.

- 
- The Registrar is usually the wireless LAN access point/router.
 - The settings page will differ depending on the brand of wireless LAN access point/router. For more information, see the instructions supplied with your wireless LAN access point/router.

If you are using a Windows® 7, Windows® 8, or Windows® 10 computer as a Registrar, complete the following steps:

6. Do one of the following:
 - Windows® 7
Click  (Start) > **Devices and Printers** > **Add a device**.
 - Windows® 8
Move your mouse to the lower right corner of your desktop. When the menu bar appears, click **Settings** > **Control Panel** > **Hardware and Sound** > **Devices and Printers** > **Add a device**.
 - Windows® 10

Click  > **Windows System** > **Control Panel**. In the **Hardware and Sound** group, click **Add a device**.



- To use a Windows® 7, Windows® 8, or Windows® 10 computer as a Registrar, you must register it to your network in advance. For more information, see the instructions supplied with your wireless LAN access point/router.
- If you use Windows® 7, Windows® 8, or Windows® 10 as a Registrar, you can install the printer driver after the wireless configuration by following the on-screen instructions. To install the full driver and software package, use the Brother installation disc.

-
7. Select your machine and click **Next**.
 8. Type the PIN displayed on the machine's LCD, and then click **Next**.
 9. (Windows® 7) Select your network, and then click **Next**.
 10. Click **Close**.

If your wireless device is connected successfully, the machine's LCD displays [Connected].

You have completed the wireless network setup. To install drivers and software necessary for operating your device, insert the Brother installation disc into your computer or go to your model's **Downloads** page on the Brother Solutions Center at support.brother.com.



Related Information

- [Additional Methods of Configuring Your Brother Machine for a Wireless Network](#)
 - [Wireless LAN Report Error Codes](#)
-

Configure Your Machine for a Wireless Network Using the Machine's Control Panel Setup Wizard

Before configuring your machine, we recommend writing down your wireless network settings. You will need this information before you continue with the configuration.

1. Check and record the current wireless network settings of the computer to which you are connecting.

Network Name (SSID)

Network Key

For example:

Network Name (SSID)
HELLO

Network Key
12345



- Your access point/router may support the use of multiple WEP keys, however your Brother machine supports the use of the first WEP key only.
- If you need assistance during setup and want to contact Brother Customer Service, make sure you have your SSID (Network Name) and Network Key ready. We cannot assist you in locating this information.
- If you do not know this information (SSID and Network Key), you cannot continue the wireless setup.

How can I find this information?

- Check the documentation provided with your wireless access point/router.
- The initial SSID could be the manufacturer's name or the model name.
- If you do not know the security information, please consult the router manufacturer, your system administrator, or your Internet provider.

2. Press  [Settings] > [All Settings] > [Network] > [WLAN] > [Setup Wizard].
3. When [Enable WLAN?] appears, press [Yes].
This will start the wireless setup wizard. To cancel, press [No].
4. The machine will search for your network and display a list of available SSIDs.
If a list of SSIDs is displayed, press ▲ or ▼ to display the SSID to which you want to connect, and then press the SSID.
5. Press [OK].
6. Do one of the following:
 - If you are using an authentication and encryption method that requires a Network Key, enter the Network Key you wrote down in the first step.
When you have entered all the characters, press [OK].
 - If your authentication method is Open System and your encryption mode is None, go to the next step.
7. The machine attempts to connect to the wireless device you have selected.

If your wireless device is connected successfully, the machine's LCD displays [Connected].

You have completed the wireless network setup. To install drivers and software necessary for operating your device, insert the Brother installation disc into your computer or go to your model's **Downloads** page on the Brother Solutions Center at support.brother.com.



Related Information

- [Additional Methods of Configuring Your Brother Machine for a Wireless Network](#)
 - [How to Enter Text on Your Brother Machine](#)
 - [Wireless LAN Report Error Codes](#)
-

Configure Your Machine for a Wireless Network When the SSID Is Not Broadcast

Before configuring your machine, we recommend writing down your wireless network settings. You will need this information before you continue with the configuration.

1. Check and write down the current wireless network settings.

Network Name (SSID)				
Communication Mode	Authentication Method	Encryption Mode	Network Key	
Infrastructure	Open System	NONE	-	
		WEP		
	Shared Key	WEP		
		WPA/WPA2-PSK	AES	
			TKIP	

For example:

Network Name (SSID)			
HELLO			
Communication Mode	Authentication Method	Encryption Mode	Network Key
Infrastructure	WPA2-PSK	AES	12345678



If your router uses WEP encryption, enter the key used as the first WEP key. Your Brother machine supports the use of the first WEP key only.

2. Press  [Settings] > [All Settings] > [Network] > [WLAN] > [Setup Wizard].
3. When [Enable WLAN?] appears, press [Yes].
This will start the wireless setup wizard. To cancel, press [No].
4. The machine will search for your network and display a list of available SSIDs. Press ▲ or ▼ to display the [<New SSID>] option.
5. Press [<New SSID>], and then press [OK].
6. Enter the SSID name, and then press [OK].
7. Press [Infrastructure] when instructed.
8. Select the Authentication Method.
9. Do one of the following:
 - If you selected the [Open System] option, press [None] or [WEP].
If you selected the [WEP] option for Encryption type, enter the WEP key, and then press [OK].
 - If you selected the [Shared Key] option, enter the WEP key, and then press [OK].
 - If you selected the [WPA/WPA2-PSK] option, press [TKIP+AES] or [AES].
Enter the WPA key, and then press [OK].



Your Brother machine supports the use of the first WEP key only.

10. The machine attempts to connect to the wireless device you have selected.

If your wireless device is connected successfully, the machine's LCD displays [Connected].

You have completed the wireless network setup. To install drivers and software necessary for operating your device, insert the Brother installation disc into your computer or go to your model's **Downloads** page on the Brother Solutions Center at support.brother.com.



Related Information

- [Additional Methods of Configuring Your Brother Machine for a Wireless Network](#)
 - [I Cannot Complete the Wireless Network Setup Configuration](#)
 - [How to Enter Text on Your Brother Machine](#)
 - [Wireless LAN Report Error Codes](#)
-

Configure Your Machine for an Enterprise Wireless Network

Before configuring your machine, we recommend writing down your wireless network settings. You will need this information before you continue with the configuration.

1. Check and record the current wireless network settings.

Network Name (SSID)

Communication Mode	Authentication Method	Encryption Mode	User ID	Password
Infrastructure	LEAP	CKIP		
	EAP-FAST/NONE	AES		
		TKIP		
	EAP-FAST/MS-CHAPv2	AES		
		TKIP		
	EAP-FAST/GTC	AES		
		TKIP		
	PEAP/MS-CHAPv2	AES		
		TKIP		
	PEAP/GTC	AES		
		TKIP		
	EAP-TTLS/CHAP	AES		
		TKIP		
	EAP-TTLS/MS-CHAP	AES		
		TKIP		
	EAP-TTLS/MS-CHAPv2	AES		
		TKIP		
	EAP-TTLS/PAP	AES		
TKIP				
EAP-TLS	AES			-
	TKIP			-

For example:

Network Name (SSID)
HELLO

Communication Mode	Authentication Method	Encryption Mode	User ID	Password
Infrastructure	EAP-FAST/MS-CHAPv2	AES	Brother	12345678



- If you configure your machine using EAP-TLS authentication, you must install the client certificate issued by a CA before you start configuration. Contact your network administrator about the client certificate. If you have installed more than one certificate, we recommend writing down the certificate name you want to use.
- If you verify your machine using the common name of the server certificate, we recommend writing down the common name before you start configuration. Contact your network administrator about the common name of the server certificate.

2. Press  [Settings] > [All Settings] > [Network] > [WLAN] > [Setup Wizard].
3. When [Enable WLAN?] appears, press [Yes].
This will start the wireless setup wizard. To cancel, press [No].
4. The machine will search for your network and display a list of available SSIDs. Press ▲ or ▼ to display the [<New SSID>] option.
5. Press [<New SSID>], and then press [OK].
6. Enter the SSID name, and then press [OK].
7. Press [Infrastructure] when instructed.
8. Select the Authentication Method.
9. Do one of the following:
 - If you selected the [LEAP] option, enter the user ID, and then press [OK]. Enter the Password, and then press [OK].
 - If you selected the [EAP-FAST], [PEAP] or [EAP-TTLS] option, press ▲ or ▼ to select the Inner Authentication Method [NONE], [CHAP], [MS-CHAP], [MS-CHAPv2], [GTC] or [PAP].



Depending on your Authentication Method, the Inner Authentication Method selections differ.

Select the Encryption Type [TKIP+AES] or [AES].

Select the Verification Method [No Verification], [CA] or [CA + Server ID].

- If you selected the [CA + Server ID] option, enter the server ID, user ID and password (if required), and then press [OK] for each option.
- For other selections, enter the user ID and Password, and then press [OK] for each option.



If you have not imported a CA certificate into your machine, the machine displays [No Verification].

- If you selected the [EAP-TLS] option, select the Encryption Type [TKIP+AES] or [AES].
When the machine displays a list of available Client Certificates, select the certificate you want.
Select the Verification Method [No Verification], [CA] or [CA + Server ID].
 - If you selected the [CA + Server ID] option, enter the server ID and user ID, and then press [OK] for each option.
 - For other selections, enter the user ID, and then press [OK].



If you have not imported a CA certificate into your machine, the machine displays [No Verification].

10. The machine attempts to connect to the wireless device you have selected.

If your wireless device is connected successfully, the machine's LCD displays [Connected].

You have completed the wireless network setup. To install drivers and software necessary for operating your device, insert the Brother installation disc into your computer or go to your model's **Downloads** page on the Brother Solutions Center at support.brother.com.



Related Information

- [Additional Methods of Configuring Your Brother Machine for a Wireless Network](#)

Use Wi-Fi Direct®

- [Print from Your Mobile Device Using Wi-Fi Direct](#)
- [Configure Your Wi-Fi Direct Network](#)
- [I Cannot Complete the Wireless Network Setup Configuration](#)

Print from Your Mobile Device Using Wi-Fi Direct

Wi-Fi Direct is one of the wireless configuration methods developed by the Wi-Fi Alliance®. It allows you to configure a secured wireless network between your Brother machine and a mobile device, such as an Android™ device, Windows® device, iPhone, iPod touch, or iPad, without using an access point. Wi-Fi Direct supports wireless network configuration using the one-push or PIN Method of Wi-Fi Protected Setup™ (WPS). You can also configure a wireless network by manually setting an SSID and password. Your Brother machine's Wi-Fi Direct feature supports WPA2™ security with AES encryption.

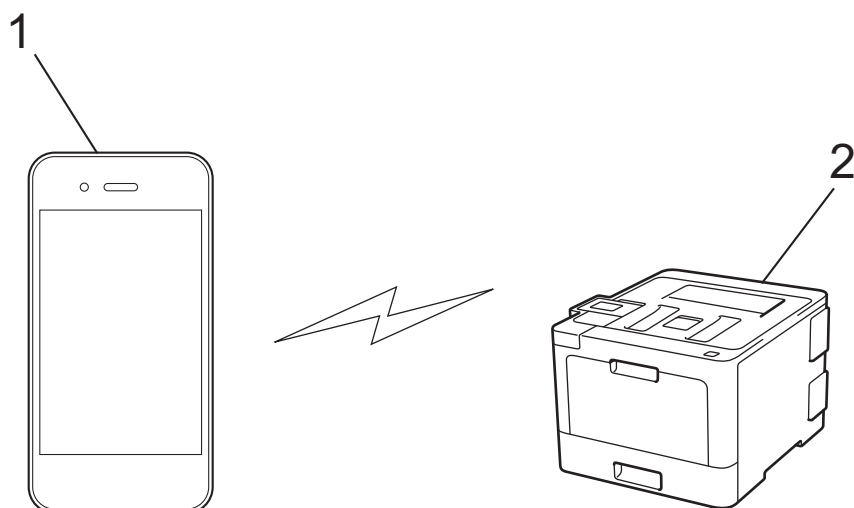

1. Mobile device
2. Your Brother machine



- Although the Brother machine can be used in both a wired and wireless network, only one connection method can be used at a time. However, a wireless network connection and Wi-Fi Direct connection, or a wired network connection (supported models only) and Wi-Fi Direct connection can be used at the same time.
- The Wi-Fi Direct-supported device can become a Group Owner (G/O). When configuring the Wi-Fi Direct network, the G/O serves as an access point.



Related Information

- [Use Wi-Fi Direct®](#)

Configure Your Wi-Fi Direct Network

Configure your Wi-Fi Direct network settings from your machine's control panel.

- [Wi-Fi Direct Network Configuration Overview](#)
- [Configure Your Wi-Fi Direct Network Using the One-Push Method](#)
- [Configure Your Wi-Fi Direct Network Using the One-Push Method of Wi-Fi Protected Setup™ \(WPS\)](#)
- [Configure Your Wi-Fi Direct Network Using the PIN Method](#)
- [Configure Your Wi-Fi Direct Network Using the PIN Method of Wi-Fi Protected Setup™ \(WPS\)](#)
- [Configure Your Wi-Fi Direct Network Manually](#)

Wi-Fi Direct Network Configuration Overview

The following instructions offer five methods for configuring your Brother machine in a wireless network environment. Select the method you prefer for your environment:

Check your mobile device for configuration.

1. Does your mobile device support Wi-Fi Direct?

Option	Description
Yes	Go to Step 2
No	Go to Step 3

2. Does your mobile device support one-push configuration for Wi-Fi Direct?

Option	Description
Yes	See <i>Related Information</i> : Configure Your Wi-Fi Direct Network Using the One-Push Method.
No	See <i>Related Information</i> : Configure Your Wi-Fi Direct Network Using the PIN Method.

3. Does your mobile device support Wi-Fi Protected Setup™ (WPS)?

Option	Description
Yes	Go to Step 4
No	See <i>Related Information</i> : Configure Your Wi-Fi Direct Network Manually.

4. Does your mobile device support one-push configuration for Wi-Fi Protected Setup™ (WPS)?

Option	Description
Yes	See <i>Related Information</i> : Configure Your Wi-Fi Direct Network Using the One-Push Method of Wi-Fi Protected Setup™ (WPS).
No	See <i>Related Information</i> : Configure Your Wi-Fi Direct Network Using the PIN Method of Wi-Fi Protected Setup™ (WPS).

To use Brother iPrint&Scan functionality in a Wi-Fi Direct network configured by one-push configuration using Wi-Fi Direct or by PIN Method configuration using Wi-Fi Direct, the device you use to configure Wi-Fi Direct must be running Android™ 4.0 or greater.

✓ Related Information

- [Configure Your Wi-Fi Direct Network](#)
- [Configure Your Wi-Fi Direct Network Using the One-Push Method](#)
- [Configure Your Wi-Fi Direct Network Using the One-Push Method of Wi-Fi Protected Setup™ \(WPS\)](#)
- [Configure Your Wi-Fi Direct Network Using the PIN Method](#)
- [Configure Your Wi-Fi Direct Network Using the PIN Method of Wi-Fi Protected Setup™ \(WPS\)](#)
- [Configure Your Wi-Fi Direct Network Manually](#)

Configure Your Wi-Fi Direct Network Using the One-Push Method

If your mobile device supports Wi-Fi Direct, follow these steps to configure a Wi-Fi Direct network:



When the machine receives the Wi-Fi Direct request from your mobile device, the message [Wi-Fi Direct connection request received. Press [OK] to connect.] will appear on the LCD. Press [OK] to connect.

1. Press  [Settings] > [All Settings] > [Network] > [Wi-Fi Direct] > [Push Button].
2. Activate Wi-Fi Direct on your mobile device (see your mobile device's user's guide for instructions) when [Activate Wi-Fi Direct on other device. Then Press [OK].] appears on the machine's LCD. Press [OK] on your machine.

This will start the Wi-Fi Direct setup. To cancel, press .

3. Do one of the following:
 - When your Brother machine is the Group Owner (G/O), connect your mobile device to the machine directly.
 - When your Brother machine is not the G/O, it displays available device names with which to configure a Wi-Fi Direct network. Select the mobile device you want to connect to. Search for available devices again by pressing [Rescan].
4. If your mobile device connects successfully, the machine's LCD displays [Connected]. You have completed the Wi-Fi Direct network setup. The Mobile Print/Scan Guide for Brother iPrint&Scan contains information on printing from your mobile device. Go to your model's **Manuals** page on the Brother Solutions Center at support.brother.com to see the guide.



Related Information



- [Configure Your Wi-Fi Direct Network](#)
- [Wi-Fi Direct Network Configuration Overview](#)

Configure Your Wi-Fi Direct Network Using the One-Push Method of Wi-Fi Protected Setup™ (WPS)

If your mobile device supports WPS (PBC: Push Button Configuration), follow these steps to configure a Wi-Fi Direct network:



When the machine receives the Wi-Fi Direct request from your mobile device, the message [Wi-Fi Direct connection request received. Press [OK] to connect.] will appear on the LCD. Press [OK] to connect.

1. Press  [Settings] > [All Settings] > [Network] > [Wi-Fi Direct] > [Group Owner].
2. Press [On].
3. Press ▲ or ▼ to select the [Push Button] option. Press [Push Button].
4. Activate your mobile device's WPS one-push configuration method (see your mobile device's user's guide for instructions) when [Activate Wi-Fi Direct on other device. Then Press [OK].] appears on the machine's LCD. Press [OK] on your Brother machine.
This will start the Wi-Fi Direct setup. To cancel, press .
5. If your mobile device connects successfully, the machine's LCD displays [Connected]. You have completed the Wi-Fi Direct network setup. The Mobile Print/Scan Guide for Brother iPrint&Scan contains information on printing from your mobile device. Go to your model's **Manuals** page on the Brother Solutions Center at support.brother.com to see the guide.



Related Information

- [Configure Your Wi-Fi Direct Network](#)
- [Wi-Fi Direct Network Configuration Overview](#)

Configure Your Wi-Fi Direct Network Using the PIN Method

If your mobile device supports the PIN Method of Wi-Fi Direct, follow these steps to configure a Wi-Fi Direct network:



When the machine receives the Wi-Fi Direct request from your mobile device, the message [Wi-Fi Direct connection request received. Press [OK] to connect.] will appear on the LCD. Press [OK] to connect.

1. Press  [Settings] > [All Settings] > [Network] > [Wi-Fi Direct] > [PIN Code].
2. Activate Wi-Fi Direct on your mobile device (see your mobile device's user's guide for instructions) when [Activate Wi-Fi Direct on other device. Then Press [OK].] appears on the machine's LCD. Press [OK] on your machine.

This will start the Wi-Fi Direct setup. To cancel, press .
3. Do one of the following:
 - When your Brother machine is the Group Owner (G/O), it will wait for a connection request from your mobile device. When [PIN Code] appears, enter the PIN displayed on your mobile device in the machine. Press [OK] to complete the setup.

If the PIN is displayed on your Brother machine, enter the PIN in your mobile device.
 - When your Brother machine is not the G/O, it displays available device names with which to configure a Wi-Fi Direct network. Select the mobile device you want to connect to. Search for available devices again by pressing [Rescan].
4. Do one of the following:
 - Press [Display PIN Code] to display the PIN on your Brother machine and enter the PIN in your mobile device. Go to the next step.
 - Press [Input PIN Code] to enter the PIN displayed by your mobile device in the machine, and then press [OK]. Go to the next step.

If your mobile device does not display a PIN, press  on your Brother machine. Go back to the first step and try again.
5. If your mobile device connects successfully, the machine's LCD displays [Connected]. You have completed the Wi-Fi Direct network setup. The Mobile Print/Scan Guide for Brother iPrint&Scan contains information on printing from your mobile device. Go to your model's **Manuals** page on the Brother Solutions Center at support.brother.com to see the guide.



Related Information

- [Configure Your Wi-Fi Direct Network](#)
- [Wi-Fi Direct Network Configuration Overview](#)

Configure Your Wi-Fi Direct Network Using the PIN Method of Wi-Fi Protected Setup™ (WPS)

If your mobile device supports the PIN Method of Wi-Fi Protected Setup™ (WPS), follow these steps to configure a Wi-Fi Direct network:



When the machine receives the Wi-Fi Direct request from your mobile device, the message [Wi-Fi Direct connection request received. Press [OK] to connect.] will appear on the LCD. Press [OK] to connect.

1. Press  [Settings] > [All Settings] > [Network] > [Wi-Fi Direct] > [Group Owner].
2. Press [On].
3. Press ▲ or ▼ to select the [PIN Code] option. Press [PIN Code].
4. When [Activate Wi-Fi Direct on other device. Then Press [OK].] appears, activate your mobile device's WPS PIN configuration method (see your mobile device's user's guide for instructions) and then press [OK] on your Brother machine.

This will start the Wi-Fi Direct setup. To cancel, press .

5. The machine will wait for a connection request from your mobile device. When [PIN Code] appears, enter the PIN displayed on your mobile device in to the machine. Press [OK].
6. If your mobile device connects successfully, the machine's LCD displays [Connected]. You have completed the Wi-Fi Direct network setup. The Mobile Print/Scan Guide for Brother iPrint&Scan contains information on printing from your mobile device. Go to your model's **Manuals** page on the Brother Solutions Center at support.brother.com to see the guide.



Related Information

- [Configure Your Wi-Fi Direct Network](#)
- [Wi-Fi Direct Network Configuration Overview](#)

Configure Your Wi-Fi Direct Network Manually

If your mobile device does not support Wi-Fi Direct or WPS, you must configure a Wi-Fi Direct network manually.



When the machine receives the Wi-Fi Direct request from your mobile device, the message [Wi-Fi Direct connection request received. Press [OK] to connect.] will appear on the LCD. Press [OK] to connect.

1. Press  [Settings] > [All Settings] > [Network] > [Wi-Fi Direct] > [Manual].
2. The machine will display the SSID name and Password for five minutes. Go to your mobile device's wireless network settings screen, select the SSID name, and then enter the password.
3. If your mobile device connects successfully, the machine's LCD displays [Connected]. You have completed the Wi-Fi Direct network setup. The Mobile Print/Scan Guide for Brother iPrint&Scan contains information on printing from your mobile device. Go to your model's **Manuals** page on the Brother Solutions Center at support.brother.com to see the guide.



Related Information

- [Configure Your Wi-Fi Direct Network](#)
- [Wi-Fi Direct Network Configuration Overview](#)

Advanced Network Features



- [Print the Network Configuration Report](#)
- [Print the WLAN Report](#)
- [Configure the SNTP Protocol Using Web Based Management](#)

Print the Network Configuration Report

The Network Configuration Report lists the network configuration, including the network print server settings.



- **Node Name:** The Node Name appears on the current Network Configuration Report. The default Node Name is "BRNxxxxxxxxxxx" for a wired network or "BRWxxxxxxxxxxx" for a wireless network (where "xxxxxxxxxxx" is your machine's MAC Address / Ethernet Address.)
- If the [IP Address] on the Network Configuration Report shows 0.0.0.0, wait for one minute and try printing it again.
- You can find your machine's settings, such as the IP address, subnet mask, node name, and MAC Address on the report, for example:
 - IP address: 192.168.0.5
 - Subnet mask: 255.255.255.0
 - Node name: BRN000ca0000499
 - MAC Address: 00-0c-a0-00-04-99

1. Press  [Settings] > [All Settings] > [Print Reports] > [Network Configuration].
2. Press [Yes].
The machine prints the Network Configuration Report.
3. Press .





Related Information

- [Advanced Network Features](#)
- [Where Can I Find My Brother Machine's Network Settings?](#)
- [Use the Network Connection Repair Tool \(Windows®\)](#)
- [Access Web Based Management](#)
- [I Want to Check that My Network Devices are Working Correctly](#)
- [Configure the Gigabit Ethernet Settings Using Web Based Management](#)

Print the WLAN Report

The WLAN Report reflects your machine's wireless status. If the wireless connection fails, check the error code on the printed report.

1. Press  [Settings] > [All Settings] > [Print Reports] > [WLAN Report].
2. Press [Yes].
The machine will print the WLAN Report.
3. Press .

If the WLAN Report does not print, check your machine for errors. If there are no visible errors, wait for one minute and then try to print the report again.



Related Information

- [Advanced Network Features](#)
- [Wireless LAN Report Error Codes](#)
- [My Brother Machine Cannot Print over the Network](#)
- [I Want to Check that My Network Devices are Working Correctly](#)

Wireless LAN Report Error Codes

If the Wireless LAN Report shows that the connection failed, check the error code on the printed report and see the corresponding instructions in the table:

Error Code	Problem and Recommended Solutions
TS-01	<p>The wireless setting is not activated, change the wireless setting to ON.</p> <p>If a network cable is connected to your machine, disconnect it and change the wireless setting of your machine to ON.</p>
TS-02	<p>The wireless access point/router cannot be detected.</p> <ol style="list-style-type: none"> Check the following two points: <ul style="list-style-type: none"> Unplug the power to your wireless access point/router, wait for 10 seconds, and then plug it back in. If your WLAN access point/router is using MAC address filtering, confirm that the MAC address of the Brother machine is allowed in the filter. If you manually entered the SSID and security information (SSID/authentication method/encryption method/Network Key), the information may be incorrect. Reconfirm the SSID and security information and re-enter the correct information as necessary. <p>This device does not support a 5 GHz SSID/ESSID and you must select a 2.4 GHz SSID/ESSID. Make sure the access point/router is set to 2.4 GHz or 2.4 GHz/5 GHz mixed mode.</p>
TS-03	<p>The wireless network and security setting you entered may be incorrect. Reconfirm the wireless network settings.</p> <p>If you do not know this information, ask your network administrator.</p>
TS-04	<p>The Authentication/Encryption methods used by the selected wireless access point/router are not supported by your machine.</p> <p>Change the authentication and encryption method of the wireless access point/router. Your machine supports the following authentication methods:</p> <ul style="list-style-type: none"> WPA-Personal TKIP or AES WPA2-Personal TKIP or AES Open WEP or None (without encryption) Shared key WEP <p>If your problem is not solved, the SSID or network settings you entered may be incorrect. Confirm the wireless network settings.</p>
TS-05	<p>The security information (SSID/Network Key) is incorrect.</p> <p>Confirm the wireless security information (Authentication method/Encryption method/Network Key).</p>
TS-06	<p>The machine cannot detect a WLAN access point/router that has WPS enabled.</p> <p>Confirm the wireless security information (Authentication method/Encryption method/Network Key).</p>
TS-07	<p>The machine cannot detect a WLAN access point/router that has WPS enabled.</p> <p>If you want to connect with WPS, you must operate both your machine and the WLAN access point/router. Confirm the connection method for WPS on WLAN access point/router and try starting again.</p> <p>If you do not know how to operate your WLAN access point/router using WPS, see the documentation provided with your WLAN access point/router, ask the manufacturer of your WLAN access point/router or ask your network administrator.</p>

Error Code	Problem and Recommended Solutions
TS-08	<p>Two or more WLAN access points that have WPS enabled are detected.</p> <ul style="list-style-type: none">• Confirm that only one WLAN access point/router within range has the WPS method active and try again.• Try starting again after few minutes in order to avoid effects from other access points.



Related Information

- [Print the WLAN Report](#)
 - [My Brother Machine Cannot Print over the Network](#)
 - [I Want to Check that My Network Devices are Working Correctly](#)
 - [Configure Your Machine for a Wireless Network Using the One Push Method of Wi-Fi Protected Setup™ \(WPS\)](#)
 - [Configure Your Machine for a Wireless Network Using the PIN Method of Wi-Fi Protected Setup™ \(WPS\)](#)
 - [Configure Your Machine for a Wireless Network Using the Machine's Control Panel Setup Wizard](#)
 - [Configure Your Machine for a Wireless Network When the SSID Is Not Broadcast](#)
 - [Configure Your Machine for an Enterprise Wireless Network](#)
-

Configure the SNTP Protocol Using Web Based Management

Configure the SNTP protocol to synchronize the time the machine uses for authentication with the time kept by the SNTP time server.

1. Start your web browser.
2. Type "http://machine's IP address" in your browser's address bar (where "machine's IP address" is the machine's IP address).

For example:

http://192.168.1.2

3. No password is required by default. Type a password if you have set one, and then click .
4. Click the **Network** tab.
5. Click the **Protocol** menu in the left navigation bar.
6. Select the **SNTP** check box to activate the settings.
7. Click **Submit**.
8. Restart your Brother machine to activate the configuration.
9. Next to the SNTP check box, click **Advanced Settings** and follow the instructions below:

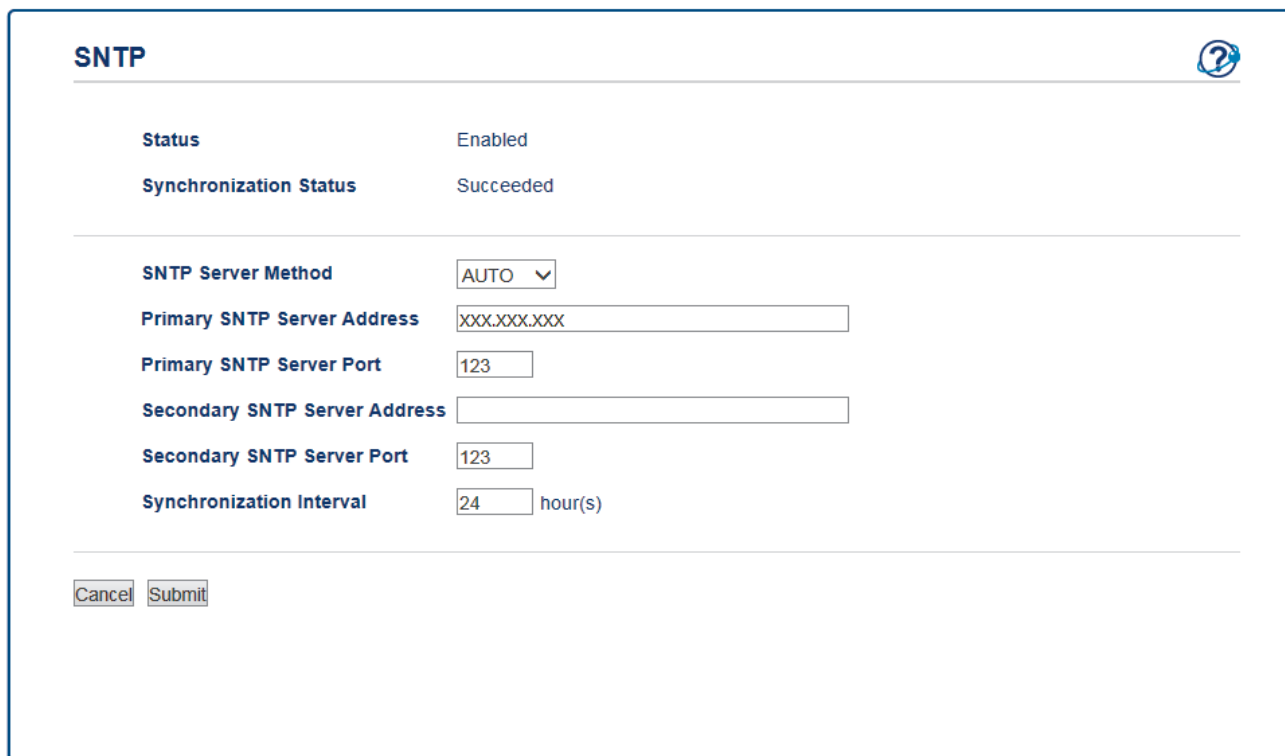

Option	Description
Status	Displays whether the SNTP protocol is enabled or disabled.
Synchronization Status	Confirm the latest synchronization status.
SNTP Server Method	Select AUTO or STATIC . <ul style="list-style-type: none">• AUTO If you have a DHCP server in your network, the SNTP server will obtain the address from that server automatically.• STATIC Type the address you want to use.

Option	Description
Primary SNTP Server Address	Type the server address (up to 64 characters).
Secondary SNTP Server Address	The secondary SNTP server address is used as a backup to the primary SNTP server address. If the primary server is unavailable, the machine will contact the secondary SNTP server.
Primary SNTP Server Port	Type the port number (1-65535).
Secondary SNTP Server Port	The secondary SNTP server port is used as a backup to the primary SNTP server port. If the primary port is unavailable, the machine will contact the secondary SNTP port.
Synchronization Interval	Type the number of hours between server synchronization attempts (1-168 hours).

10. Click **Submit**.



Related Information

- [Advanced Network Features](#)
-

Technical Information for Advanced Users

- [Gigabit Ethernet \(Wired Network Only\)](#)
- [Reset the Network Settings to the Factory Settings](#)

Gigabit Ethernet (Wired Network Only)

Your machine supports 1000BASE-T Gigabit Ethernet. To connect to a 1000BASE-T Gigabit Ethernet Network, you must set the machine's Ethernet link mode to Auto from the machine's control panel or Web Based Management (web browser).



- Use a straight-through Category 5e (or greater) twisted-pair cable. When you connect the machine to a Gigabit Ethernet Network, use the network devices complying with 1000BASE-T.



Related Information

- [Technical Information for Advanced Users](#)
- [Configure the Gigabit Ethernet Settings Using Web Based Management](#)

Configure the Gigabit Ethernet Settings Using Web Based Management

1. Start your web browser.
2. Type "http://machine's IP address" in your browser's address bar (where "machine's IP address" is the machine's IP address).
For example:
http://192.168.1.2
3. No password is required by default. Type a password if you have set one, and then click .
4. Click the **Network** tab.
5. Click **Wired**.
6. Click **Ethernet** in the left navigation bar.
7. Select **Auto** from the **Ethernet Mode** drop-down list.
8. Click **Submit**.
9. To enable the settings, restart your machine.

You can confirm your settings by printing the Network Configuration Report.

Related Information

- [Gigabit Ethernet \(Wired Network Only\)](#)
- [Print the Network Configuration Report](#)

Reset the Network Settings to the Factory Settings

You can use your machine's control panel to reset the print server to its default factory settings. This resets all information, such as the password and IP address.



- This feature restores all wired (supported models only) and wireless network settings to the factory settings.
- You can also reset the print server to its factory settings using BRAdmin Light, BRAdmin Professional 3, or Web Based Management.

1. Press  [Settings] > [All Settings] > [Network] > [Network Reset].
2. [Reboot OK?] will be displayed. Press [Yes] for two seconds to confirm.
The machine will restart.



Related Information

- [Technical Information for Advanced Users](#)

Security

- [Lock the Machine Settings](#)
- [Network Security Features](#)

Lock the Machine Settings

Before turning on the machine's Access Lock, make a careful note of your password. If you forget the password, you must reset all passwords stored in the machine by contacting your administrator or Brother Customer Service.

- [Setting Lock Overview](#)



Setting Lock Overview

Use the Setting Lock feature to block unauthorized access to machine settings.

When Setting Lock is set to On, you cannot access the machine settings without entering the password.

- [Set the Setting Lock Password](#)
- [Change the Setting Lock Password](#)
- [Turn On Setting Lock](#)

Set the Setting Lock Password



1. Press  [Settings] > [All Settings] > [General Setup] > [Setting Lock].
2. Enter a four-digit number for the password.
3. Press [OK].
4. When the LCD displays [Verify], re-enter the new password.
5. Press [OK].
6. Press .



Related Information

- [Setting Lock Overview](#)

Change the Setting Lock Password

1. Press  [Settings] > [All Settings] > [General Setup] > [Setting Lock] > [Set Password].
2. Enter the current four-digit password.
3. Press [OK].
4. Enter a new four-digit password.
5. Press [OK].
6. When the LCD displays [Verify], re-enter the new password.
7. Press [OK].
8. Press .



Related Information

- [Setting Lock Overview](#)

Turn On Setting Lock

1. Press  [Settings] > [All Settings] > [General Setup] > [Setting Lock] > [Lock Off⇒On].
2. Enter the current four-digit password.
3. Press [OK].



To turn off Setting Lock, press  on the LCD, enter the current four-digit password, and then press [OK].



Related Information

- [Setting Lock Overview](#)

Network Security Features

- [Before Using Network Security Features](#)
- [Secure Function Lock 3.0](#)
- [Use Active Directory® Authentication](#)
- [Use LDAP Authentication](#)
- [Manage Your Network Machine Securely Using SSL/TLS](#)
- [Manage Your Network Machine Securely Using IPsec](#)
- [Send an Email Securely](#)
- [Use IEEE 802.1x Authentication for a Wired or a Wireless Network](#)
- [Store Print Log to Network](#)

Before Using Network Security Features

Your Brother machine employs some of the latest network security and encryption protocols available today. These network features can be integrated into your overall network security plan to help protect your data and prevent unauthorized access to the machine.



We recommend disabling the Telnet, FTP server and TFTP protocols. Accessing the machine using these protocols is not secure.



Related Information

- [Network Security Features](#)
-

Secure Function Lock 3.0

Brother's Secure Function Lock 3.0 increases security by restricting the functions available on your Brother machine.

- [Before Using Secure Function Lock 3.0](#)
- [Configure Secure Function Lock 3.0 Using Web Based Management](#)
- [Configure Public Mode for Secure Function Lock 3.0](#)
- [Additional Secure Function Lock 3.0 Features](#)
- [Register a new ID Card Using the Machine's Control Panel](#)

Before Using Secure Function Lock 3.0

Use Secure Function Lock to configure passwords, set specific user page limits, and grant access to some or all of the functions listed here.

You can configure and change the following Secure Function Lock 3.0 settings using Web Based Management or BRAdmin Professional 3 (Windows®):

- **Print**

Print includes print jobs sent via AirPrint, Google Cloud Print™ and Brother iPrint&Scan.

If you register users' login names in advance, the users do not need to enter their passwords when they use the print function.

- **Color Print**

- USB Direct Print

- **Web Connect** (supported models only)

- **Page Limits**

- **Page Counters**

- **Card ID (NFC ID)** (supported models only)

If you register users' Card IDs in advance, registered users can activate the machine by touching their registered cards to the machines' NFC symbol.



Related Information

- [Secure Function Lock 3.0](#)

Configure Secure Function Lock 3.0 Using Web Based Management

1. Start your web browser.
2. Type "http://machine's IP address" in your browser's address bar (where "machine's IP address" is the machine's IP address).
For example:
http://192.168.1.2
3. No password is required by default. Type a password if you have set one, and then click .
4. Click the **Administrator** tab.
5. Click the **User Restriction Function** menu in the left navigation bar.
6. Select **Secure Function Lock**.
7. Click **Submit**.
8. Click the **Restricted Functions** menu in the left navigation bar.
9. In the **User List / Restricted Functions** field, type a group name or user name.
10. In the **Print** and the other columns, select a check box to allow or clear a check box to restrict the function listed.
11. To configure the maximum page count, select the **On** check box in the **Page Limits** column, and then type the maximum number in the **Max. Pages** field.
12. Click **Submit**.
13. Click the **User List** menu in the left navigation bar.
14. In the **User List** field, type the user name.
15. In the **PIN Number** field, type a four-digit password.
16. To register the user's Card ID, type the card number in the **Card ID (NFC ID)** field (Available only for certain models) .
17. Select **User List / Restricted Functions** from the drop-down list for each user.
18. Click **Submit**.



Related Information

- [Secure Function Lock 3.0](#)

Configure Public Mode for Secure Function Lock 3.0

Use the Secure Function Lock screen to set up Public Mode, which limits the functions available to public users. Public users will not need to enter a password to access the features made available through Public Mode settings.



Public Mode includes print jobs sent via AirPrint, Google Cloud Print™ and Brother iPrint&Scan.

1. Start your web browser.
2. Type "http://machine's IP address" in your browser's address bar (where "machine's IP address" is the machine's IP address).
For example:
http://192.168.1.2
3. No password is required by default. Type a password if you have set one, and then click .
4. Click the **Administrator** tab.
5. Click the **User Restriction Function** menu in the left navigation bar.
6. Select **Secure Function Lock**.
7. Click **Submit**.
8. Click the **Restricted Functions** menu.
9. In the **Public Mode** row, select a check box to allow or clear a check box to restrict the function listed.
10. Click **Submit**.



Related Information

- [Secure Function Lock 3.0](#)
- [Register Your Machine with Google Cloud Print Using Web Based Management](#)

Additional Secure Function Lock 3.0 Features

Configure the following features in the Secure Function Lock screen:

All Counter Reset

Click **All Counter Reset**, in the **Page Counters** column, to reset the page counter.

Export to CSV file

Click **Export to CSV file**, to export the current page counter including **User List / Restricted Functions** information as a CSV file.

Card ID (NFC ID) (supported models only)

Click the **User List** menu, and then type a users' Card ID in the **Card ID (NFC ID)** field. You can use your ID card for authentication.

Last Counter Record

Click **Last Counter Record** if you want the machine to retain the page count after the counter has been reset.



Related Information

- [Secure Function Lock 3.0](#)

Register a new ID Card Using the Machine's Control Panel

1. Touch the NFC symbol on the machine's control panel with a registered ID Card.
2. Press your login name.
3. Press [Register Card].
4. Touch a new ID Card to the NFC symbol.
5. Press [OK].

The new ID Card's number is registered to the machine.



For the supported ID Card types, go to the Brother Solutions Center at support.brother.com to see the **FAQs & Troubleshooting** page.



Related Information

- [Secure Function Lock 3.0](#)

Use Active Directory® Authentication

- [Introduction to Active Directory® Authentication](#)
- [Configure Active Directory® Authentication Using Web Based Management](#)
- [Log On to Change the Machine Settings Using the Machine's Control Panel \(Active Directory® Authentication\)](#)

Introduction to Active Directory® Authentication

Active Directory® Authentication restricts the use of your Brother machine. If Active Directory® Authentication is enabled, the machine's control panel will be locked. You cannot change the machine's settings until you enter a User ID and password.

Active Directory® Authentication offers the following feature:

- Stores incoming print data

You can change the Active Directory® Authentication settings using Web Based Management or BRAdmin Professional 3 (Windows®).



Related Information

- [Use Active Directory® Authentication](#)
-

Configure Active Directory® Authentication Using Web Based Management

Active Directory® authentication supports Kerberos authentication and NTLMv2 authentication. You must configure the SNTP protocol (network time server) and DNS server configuration for authentication.

1. Start your web browser.
2. Type "http://machine's IP address" in your browser's address bar (where "machine's IP address" is the machine's IP address).
For example:
http://192.168.1.2
3. No password is required by default. Type a password if you have set one, and then click .
4. Click the **Administrator** tab.
5. Click the **User Restriction Function** menu in the left navigation bar.
6. Select **Active Directory Authentication**.
7. Click **Submit**.
8. Select **Active Directory Authentication** in the left navigation bar.
9. Configure the following settings:

Option	Description
Storage PC Print Data	Select this option to store incoming print data. After you log on to the machine, your PC print jobs will be printed automatically. This feature is available only for print data created by a Brother native printer driver.
Remember User ID	Select this option to save your User ID.
Active Directory Server Address	Type the IP address or the server name (for example: ad.example.com) of the Active Directory® Server.
Active Directory Domain Name	Type the Active Directory® domain name.
Protocol & Authentication Method	Select the protocol and authentication method.
LDAP Server Port	Type the port number to connect the Active Directory® server via LDAP (available only for LDAP + kerberos authentication method).

10. Click **Submit**.



Related Information

- [Use Active Directory® Authentication](#)

Log On to Change the Machine Settings Using the Machine's Control Panel (Active Directory® Authentication)

When Active Directory® Authentication is enabled, the machine's control panel will be locked until you enter your User ID and password on the machine's control panel.

1. On the machine's control panel, enter your User ID.
2. Press [OK].
3. Enter your password.
4. Press [OK].
5. When authentication is successful, the machine's control panel will be unlocked.



Related Information

- [Use Active Directory® Authentication](#)

Use LDAP Authentication

- [Introduction to LDAP Authentication](#)
- [Configure LDAP Authentication Using Web Based Management](#)
- [Log On to Change the Machine Settings Using the Machine's Control Panel \(LDAP Authentication\)](#)

Introduction to LDAP Authentication

LDAP Authentication restricts the use of your Brother machine. If LDAP Authentication is enabled, the machine's control panel will be locked. You cannot change the machine's settings until you enter a User ID and password.

LDAP Authentication offers the following feature:

- Stores incoming print data

You can change the LDAP Authentication settings using Web Based Management or BRAdmin Professional 3 (Windows®).



Related Information

- [Use LDAP Authentication](#)
-

Configure LDAP Authentication Using Web Based Management

1. Start your web browser.
2. Type "http://machine's IP address" in your browser's address bar (where "machine's IP address" is the machine's IP address).
For example:
http://192.168.1.2
3. No password is required by default. Type a password if you have set one, and then click .
4. Click the **Administrator** tab.
5. Click the **User Restriction Function** menu in the left navigation bar.
6. Select **LDAP Authentication**.
7. Click **Submit**.
8. Click **LDAP Authentication** in the left navigation bar.
9. Configure the following settings:

Option	Description
Storage PC Print Data	Select this option to store incoming print data. After you log on to the machine, your PC print jobs will be printed automatically. This feature is available only for print data created by a Brother native printer driver.
Remember User ID	Select this option to save your User ID.
LDAP Server Address	Type the IP address or the server name (for example: ldap.example.com) of the LDAP server.
LDAP Server Port	Type the LDAP server port number.
LDAP Search Root	Type the LDAP search root directory.
Attribute of Name (Search Key)	Type the attribute you want to use as a search key.

10. Click **Submit**.



Related Information

- [Use LDAP Authentication](#)

Log On to Change the Machine Settings Using the Machine's Control Panel (LDAP Authentication)

When LDAP Authentication is enabled, the machine's control panel will be locked until you enter your User ID and password on the machine's control panel.

1. On the machine's control panel, enter your User ID and Password.
2. Press [OK].
3. When authentication is successful, the machine's control panel will be unlocked.



Related Information

- [Use LDAP Authentication](#)

Manage Your Network Machine Securely Using SSL/TLS

- [Introduction to SSL/TLS](#)
- [Certificates and Web Based Management](#)
- [Manage Your Network Machine Securely Using Web Based Management](#)
- [Manage Your Network Machine Securely Using BRAdmin Professional 3 \(Windows®\)](#)
- [Print Documents Securely Using SSL/TLS](#)

Introduction to SSL/TLS

Secure Socket Layer (SSL) or Transport Layer Security (TLS) is an effective method of protecting data sent over a local or wide area network (LAN or WAN). It works by encrypting data, such as a print job, sent over a network, so anyone trying to capture it will not be able to read it.

SSL/TLS can be configured on both wired and wireless networks and will work with other forms of security such as WPA keys and firewalls.



Related Information

- [Manage Your Network Machine Securely Using SSL/TLS](#)
 - [Brief History of SSL/TLS](#)
 - [Benefits of Using SSL/TLS](#)
-

Brief History of SSL/TLS

SSL/TLS was originally created to secure web traffic information, particularly data sent between web browsers and servers. For example, when you use Internet Explorer® for Internet Banking and you see https:// and the little padlock icon in the web browser, you are using SSL. SSL grew to work with additional applications, such as Telnet, printer, and FTP software, in order to become a universal solution for online security. Its original design intentions are still being used today by many online retailers and banks to secure sensitive data, such as credit card numbers, customer records, etc.

SSL/TLS uses extremely high levels of encryption and is trusted by banks all over the world.



Related Information

- [Introduction to SSL/TLS](#)
-

Benefits of Using SSL/TLS

The primary benefit of using SSL/TLS on Brother machines is to guarantee secure printing over an IP network by restricting unauthorized users from reading data sent to the machine. SSL's key selling point is that it can be used to print confidential data securely. For example, an HR department in a large company may be printing wage slips on a regular basis. Without encryption, the data contained on these wages slips can be read by other network users. However, with SSL/TLS, anyone trying to capture the data will see a confusing page of code and not the actual wage slip.



Related Information

- [Introduction to SSL/TLS](#)
-

Certificates and Web Based Management

You must configure a certificate to manage your networked Brother machine securely using SSL/TLS. You must use Web Based Management to configure a certificate.

- [Supported Security Certificate Features](#)
- [Create and Install a Certificate](#)
- [Manage Multiple Certificates](#)

Supported Security Certificate Features

Your Brother machine supports the use of multiple security certificates, which allows secure management, authentication, and communication with the machine. The following security certificate features can be used with the machine:

- SSL/TLS communication
- SSL communication for SMTP
- IEEE 802.1x authentication
- IPsec

The Brother machine supports the following:

- Pre-installed certificate

Your machine has a pre-installed self-signed certificate. This certificate enables you to use SSL/TLS communication without creating or installing a different certificate.



The pre-installed self-signed certificate cannot protect your communication from being compromised. We recommend using a certificate that is issued by a trusted organization for better security.

- Self-signed certificate

This print server issues its own certificate. Using this certificate, you can easily use the SSL/TLS communication without creating or installing a different certificate from a CA.

- Certificate from a Certificate Authority (CA)

There are two methods for installing a certificate from a CA. If you already have a certificate from a CA or if you want to use a certificate from an external trusted CA:

- When using a Certificate Signing Request (CSR) from this print server.
- When importing a certificate and a private key.

- Certificate Authority (CA) Certificate

To use a CA certificate that identifies the CA and owns its private key, you must import that CA certificate from the CA before configuring the security features of the Network.



- If you are going to use SSL/TLS communication, we recommend contacting your system administrator first.
- When you reset the print server back to its default factory settings, the certificate and the private key that are installed will be deleted. If you want to keep the same certificate and the private key after resetting the print server, export them before resetting, and then reinstall them.



Related Information

- [Certificates and Web Based Management](#)

Create and Install a Certificate

- [Step by Step Guide for Creating and Installing a Certificate](#)
- [Create and Install a Self-signed Certificate](#)
- [Create and Install a Certificate from a Certificate Authority \(CA\)](#)
- [Import and Export a CA Certificate](#)

Step by Step Guide for Creating and Installing a Certificate

There are two options when choosing a security certificate: use a self-signed certificate or use a certificate from a Certificate Authority (CA).

These are a brief summary of the actions required, based on the option you choose.

Option 1

Self-Signed Certificate

1. Create a self-signed certificate using Web Based Management.
2. Install the self-signed certificate on your computer.

Option 2

Certificate from a CA

1. Create a Certificate Signing Request (CSR) using Web Based Management.
2. Install the certificate issued by the CA on your Brother machine using Web Based Management.
3. Install the certificate on your computer.



Related Information

- [Create and Install a Certificate](#)

Create and Install a Self-signed Certificate

- [Create a Self-signed Certificate](#)
- [Install the Self-signed Certificate for Windows® users with Administrator Rights](#)
- [Import and Export the Self-signed Certificate on your Brother Machine](#)

Create a Self-signed Certificate

1. Start your web browser.
2. Type "http://machine's IP address" in your browser's address bar (where "machine's IP address" is the machine's IP address).

For example:

http://192.168.1.2



- If you are using a Domain Name System or enable a NetBIOS name, you can type another name, such as "SharedPrinter" instead of the IP address.

- For example:

http://SharedPrinter

If you enable a NetBIOS name, you can also use the node name.

- For example:

http://brnxxxxxxxxxxxx

The NetBIOS name can be found in the Network Configuration Report.

- For Macintosh, access Web Based Management by clicking the machine's icon on the **Status Monitor** screen.

3. No password is required by default. Type a password if you have set one, and then click .
4. Click the **Network** tab.
5. Click the **Security** tab.
6. Click **Certificate**.
7. Click **Create Self-Signed Certificate**.
8. Enter a **Common Name** and a **Valid Date**.
 - The length of the **Common Name** is less than 64 bytes. Enter an identifier, such as an IP address, node name, or domain name to use when accessing this machine through SSL/TLS communication. The node name is displayed by default.
 - A warning will appear if you use the IPPS or HTTPS protocol and enter a different name in the URL than the **Common Name** that was used for the self-signed certificate.
9. Select your setting from the **Public Key Algorithm** drop-down list. The default setting is **RSA(2048bit)**.
10. Select your setting from the **Digest Algorithm** drop-down list. The default setting is **SHA256**.
11. Click **Submit**.
12. Click **Network**.
13. Click **Protocol**.
14. Click **HTTP Server Settings**.
15. Select the certificate you want to configure from the **Select the Certificate** drop-down list.
16. Click **Submit**.

The following screen appears.

HTTP Server Settings

The setting for high security in communication was done.

To activate your new settings, this Device needs to restart.

Note: Any jobs in progress will be aborted.

To activate other protocols that have secure settings after restarting, check the box below.

Activate other protocols that have secure settings.

Would you like to restart immediately?

Yes

No

17. Click **Yes** to restart your print server.

The self-signed certificate is created and saved in your machine's memory.

To use SSL/TLS communication, the self-signed certificate must be installed on your computer.







Related Information

- [Create and Install a Self-signed Certificate](#)

Install the Self-signed Certificate for Windows® users with Administrator Rights

The following steps are for Microsoft® Internet Explorer®. If you use another web browser, consult the documentation for your web browser to get help with installing certificates.

1. Do one of the following:
 - (Windows® 7 and Windows Server® 2008)
Click  (**Start**) > **All Programs**.
 - (Windows® 8)
Right-click the  (**Internet Explorer**) icon on the taskbar.
 - (Windows® 10 and Windows Server® 2016)
Click  **Windows Accessories**.
 - (Windows Server® 2012 and Windows Server® 2012 R2)
Click  (**Internet Explorer**), and then right-click the  (**Internet Explorer**) icon that appears on the taskbar.
2. Right-click **Internet Explorer**, and then click **Run as administrator**.



If the **More** option appears, click **More**.

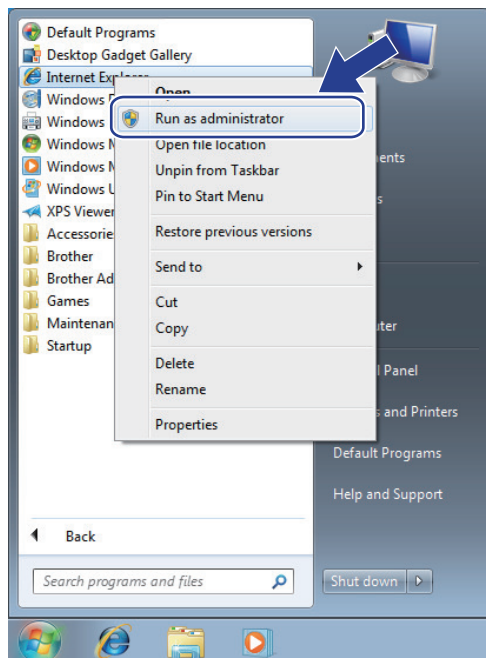

If the **User Account Control** screen appears, click **Yes**.

3. Type "https://machine's IP address" in your browser's address bar to access your machine (where "machine's IP address" is the machine's IP address or the node name that you assigned for the certificate).

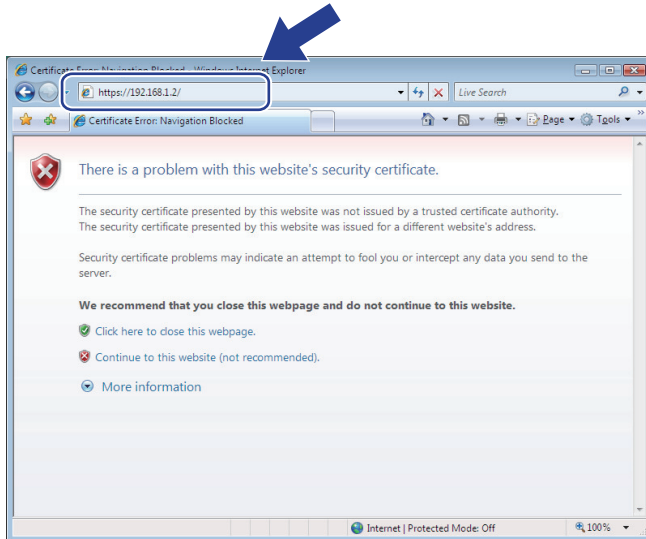

4. Click **Continue to this website (not recommended)**.

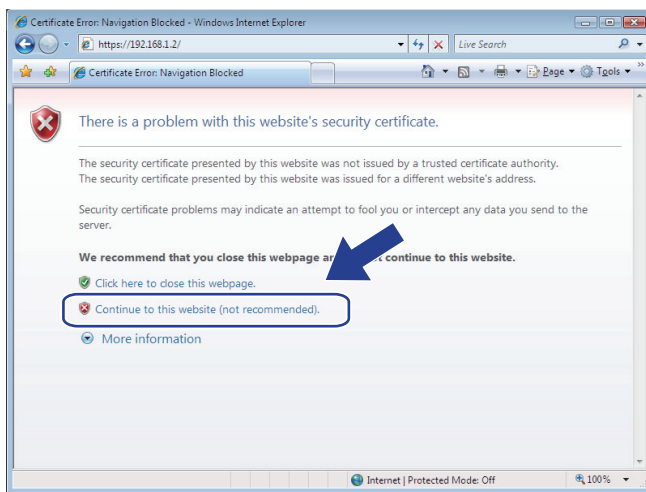

5. Click **Certificate error**, and then click **View certificates**.

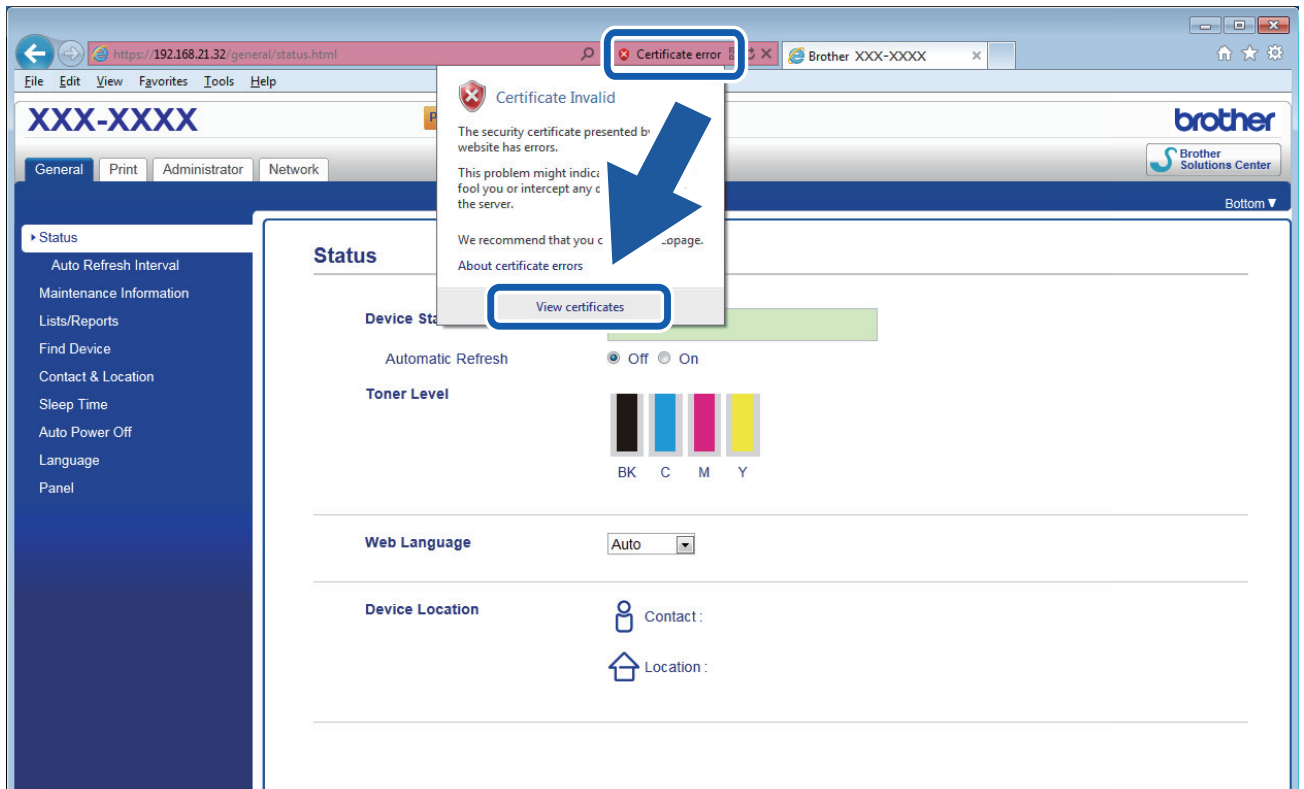

6. Click **Install Certificate....**

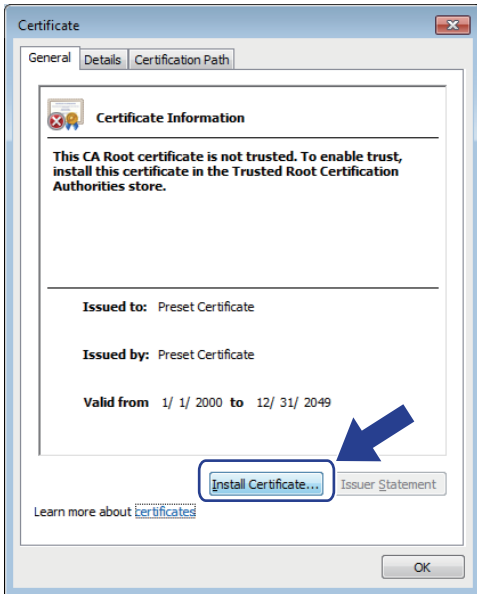

7. When the **Certificate Import Wizard** appears, click **Next**.
8. Select **Place all certificates in the following store**, and then click **Browse...**.

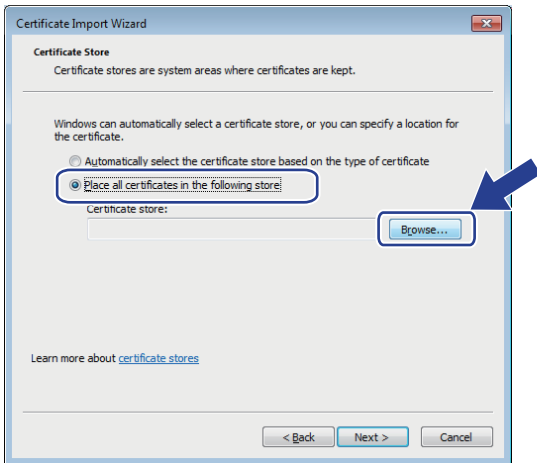

9. Select **Trusted Root Certification Authorities**, and then click **OK**.



10. Click **Next**.

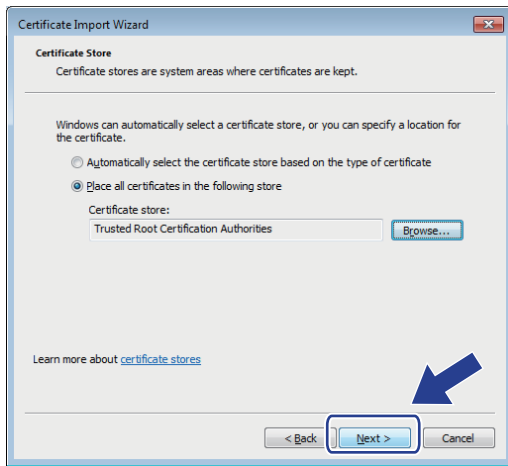

11. Click **Finish**.

12. Click **Yes**, if the fingerprint (thumbprint) is correct.

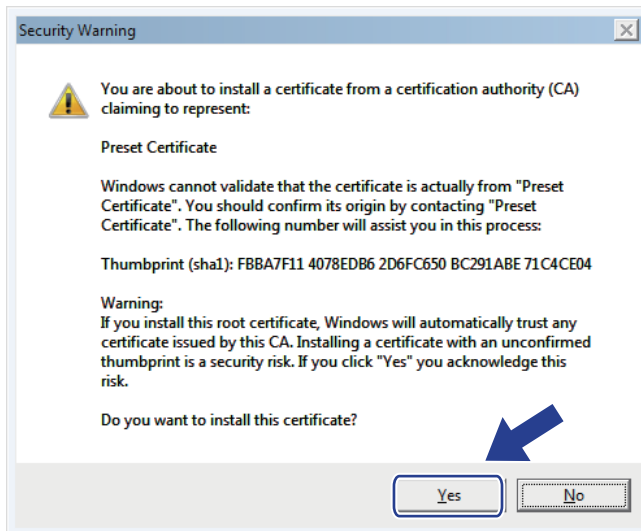

The fingerprint (thumbprint) is printed on the Network Configuration Report.

13. Click **OK**.

The self-signed certificate is now installed on your computer, and SSL/TLS communication is available.



Related Information

- [Create and Install a Self-signed Certificate](#)

Import and Export the Self-signed Certificate on your Brother Machine

You can store the self-signed certificates on your Brother machine and manage them by importing and exporting.

- [Import the Self-signed Certificate](#)
- [Export the Self-signed Certificate](#)

Import the Self-signed Certificate

1. Start your web browser.
2. Type "http://machine's IP address" in your browser's address bar (where "machine's IP address" is the machine's IP address).

For example:

http://192.168.1.2



- If you are using a Domain Name System or enable a NetBIOS name, you can type another name, such as "SharedPrinter" instead of the IP address.

- For example:

http://SharedPrinter

If you enable a NetBIOS name, you can also use the node name.

- For example:

http://brnxxxxxxxxxxxx

The NetBIOS name can be found in the Network Configuration Report.

- For Macintosh, access Web Based Management by clicking the machine's icon on the **Status Monitor** screen.

3. No password is required by default. Type a password if you have set one, and then click .
4. Click the **Network** tab.
5. Click the **Security** tab.
6. Click **Certificate**.
7. Click **Import Certificate and Private Key**.
8. Browse to the file you want to import.
9. Type the password if the file is encrypted, and then click **Submit**.

The self-signed certificate is imported to your machine.

To use SSL/TLS communication, the self-signed certificate must also be installed on your computer. Contact your network administrator.



Related Information

- [Import and Export the Self-signed Certificate on your Brother Machine](#)

Export the Self-signed Certificate

1. Start your web browser.
2. Type "http://machine's IP address" in your browser's address bar (where "machine's IP address" is the machine's IP address).

For example:

http://192.168.1.2



- If you are using a Domain Name System or enable a NetBIOS name, you can type another name, such as "SharedPrinter" instead of the IP address.

- For example:

http://SharedPrinter

If you enable a NetBIOS name, you can also use the node name.

- For example:

http://brnxxxxxxxxxxxx

The NetBIOS name can be found in the Network Configuration Report.

- For Macintosh, access Web Based Management by clicking the machine's icon on the **Status Monitor** screen.

3. No password is required by default. Type a password if you have set one, and then click .
4. Click the **Network** tab.
5. Click the **Security** tab.
6. Click **Certificate**.
7. Click **Export** shown with **Certificate List**.
8. If you want to encrypt the file, type a password in the **Enter password** field.
If the **Enter password** field is blank, your output file will not be encrypted.
9. Type the password again in the **Retype password** field, and then click **Submit**.
10. Click **Save**.
11. Specify the location where you want to save the file.

The self-signed certificate is exported to your computer.

You can also import the self-signed certificate to your computer.



Related Information

- [Import and Export the Self-signed Certificate on your Brother Machine](#)

Create and Install a Certificate from a Certificate Authority (CA)

If you already have a certificate from an external trusted CA, you can store the certificate and private key on the machine and manage them by importing and exporting. If you do not have a certificate from an external trusted CA, create a Certificate Signing Request (CSR), send it to a CA for authentication, and install the returned certificate on your machine.

- [Create a Certificate Signing Request \(CSR\)](#)
- [Install a Certificate on Your Brother Machine](#)
- [Import and Export the Certificate and Private Key](#)

Create a Certificate Signing Request (CSR)

A Certificate Signing Request (CSR) is a request sent to a Certificate Authority (CA) to authenticate the credentials contained within the certificate.

We recommend installing a Root Certificate from the CA on your computer before creating the CSR.

1. Start your web browser.
2. Type "http://machine's IP address" in your browser's address bar (where "machine's IP address" is the machine's IP address).

For example:

http://192.168.1.2



- If you are using a Domain Name System or enable a NetBIOS name, you can type another name, such as "SharedPrinter" instead of the IP address.

- For example:

http://SharedPrinter

If you enable a NetBIOS name, you can also use the node name.

- For example:

http://brnxxxxxxxxxxxx

The NetBIOS name can be found in the Network Configuration Report.

- For Macintosh, access Web Based Management by clicking the machine's icon on the **Status Monitor** screen.

3. No password is required by default. Type a password if you have set one, and then click .
4. Click the **Network** tab.
5. Click the **Security** tab.
6. Click **Certificate**.
7. Click **Create CSR**.
8. Type a **Common Name** (required) and add other information about your **Organization** (optional).



- Your company details are required so that a CA can confirm your identity and verify it to the outside world.
- The length of the **Common Name** must be less than 64 bytes. Enter an identifier, such as an IP address, node name, or domain name to use when accessing this printer through SSL/TLS communication. The node name is displayed by default. The **Common Name** is required.
- A warning will appear if you type a different name in the URL than the Common Name that was used for the certificate.
- The length of the **Organization**, the **Organization Unit**, the **City/Locality** and the **State/Province** must be less than 64 bytes.
- The **Country/Region** should be a two character ISO 3166 country code.
- If you are configuring an X.509v3 certificate extension, select the **Configure extended partition** check box, and then select **Auto (Register IPv4)** or **Manual**.

9. Select your setting from the **Public Key Algorithm** drop-down list. The default setting is **RSA(2048bit)**.
10. Select your setting from the **Digest Algorithm** drop-down list. The default setting is **SHA256**.
11. Click **Submit**.

The CSR appears on your screen. Save the CSR as a file or copy and paste it into an online CSR form offered by a Certificate Authority.

12. Click **Save**.



- Follow your CA's policy regarding the method to send a CSR to your CA.
 - If you are using the Enterprise root CA of Windows Server® 2008/2012/2012 R2/2016, we recommend using the Web Server for the certificate template to securely create the Client Certificate. If you are creating a Client Certificate for an IEEE 802.1x environment with EAP-TLS authentication, we recommend using User for the certificate template. For more information, go to your model's page on the Brother Solutions Center at support.brother.com.
-



Related Information

- [Create and Install a Certificate from a Certificate Authority \(CA\)](#)
-

Install a Certificate on Your Brother Machine

When you receive a certificate from a CA, follow the steps below to install it into the print server:

Only a certificate issued with your machine's CSR can be installed onto the machine. When you want to create another CSR, make sure that the certificate is installed before creating another CSR. Create another CSR only after installing the certificate on the machine. If you do not, the CSR you create before installing will be invalid.

1. Start your web browser.
2. Type "http://machine's IP address" in your browser's address bar (where "machine's IP address" is the machine's IP address).

For example:

http://192.168.1.2



- If you are using a Domain Name System or enable a NetBIOS name, you can type another name, such as "SharedPrinter" instead of the IP address.

- For example:

http://SharedPrinter

If you enable a NetBIOS name, you can also use the node name.

- For example:

http://brnxxxxxxxxxxxx

The NetBIOS name can be found in the Network Configuration Report.

- For Macintosh, access Web Based Management by clicking the machine's icon on the **Status Monitor** screen.

3. No password is required by default. Type a password if you have set one, and then click .
4. Click the **Network** tab.
5. Click the **Security** tab.
6. Click **Certificate**.
7. Click **Install Certificate**.
8. Browse to the file that contains the certificate issued by the CA, and then click **Submit**.

The certificate has been created successfully and saved in your machine's memory successfully.

To use SSL/TLS communication, the Root Certificate from the CA must be installed on your computer. Contact your network administrator.



Related Information

- [Create and Install a Certificate from a Certificate Authority \(CA\)](#)

Import and Export the Certificate and Private Key

Store the certificate and private key on your machine and manage them by importing and exporting them.

- [Import a Certificate and Private Key](#)
- [Export the Certificate and Private Key](#)

Import a Certificate and Private Key

1. Start your web browser.
2. Type "http://machine's IP address" in your browser's address bar (where "machine's IP address" is the machine's IP address).

For example:

http://192.168.1.2



- If you are using a Domain Name System or enable a NetBIOS name, you can type another name, such as "SharedPrinter" instead of the IP address.

- For example:

http://SharedPrinter

If you enable a NetBIOS name, you can also use the node name.

- For example:

http://brnxxxxxxxxxxxx

The NetBIOS name can be found in the Network Configuration Report.

- For Macintosh, access Web Based Management by clicking the machine's icon on the **Status Monitor** screen.

3. No password is required by default. Type a password if you have set one, and then click .
4. Click the **Network** tab.
5. Click the **Security** tab.
6. Click **Certificate**.
7. Click **Import Certificate and Private Key**.
8. Browse to the file you want to import.
9. Type the password if the file is encrypted, and then click **Submit**.

The certificate and private key are imported to your machine.

To use SSL/TLS communication, the Root Certificate from the CA must also be installed on your computer. Contact your network administrator.



Related Information

- [Import and Export the Certificate and Private Key](#)

Export the Certificate and Private Key

1. Start your web browser.
2. Type "http://machine's IP address" in your browser's address bar (where "machine's IP address" is the machine's IP address).

For example:

http://192.168.1.2



- If you are using a Domain Name System or enable a NetBIOS name, you can type another name, such as "SharedPrinter" instead of the IP address.

- For example:

http://SharedPrinter

If you enable a NetBIOS name, you can also use the node name.

- For example:

http://brnxxxxxxxxxxxx

The NetBIOS name can be found in the Network Configuration Report.

- For Macintosh, access Web Based Management by clicking the machine's icon on the **Status Monitor** screen.

3. No password is required by default. Type a password if you have set one, and then click .
4. Click the **Network** tab.
5. Click the **Security** tab.
6. Click **Certificate**.
7. Click **Export** shown with **Certificate List**.
8. Enter the password if you want to encrypt the file.
If a blank password is used, the output is not encrypted.
9. Enter the password again for confirmation, and then click **Submit**.
10. Click **Save**.
11. Specify the location where you want to save the file.

The certificate and private key are exported to your computer.

You can also import the certificate to your computer.



Related Information

- [Import and Export the Certificate and Private Key](#)

Import and Export a CA Certificate

You can import, export and store CA certificates on your Brother machine.

- [Import a CA Certificate](#)
- [Export a CA Certificate](#)

Import a CA Certificate

1. Start your web browser.
2. Type "http://machine's IP address" in your browser's address bar (where "machine's IP address" is the machine's IP address).

For example:

http://192.168.1.2



- If you are using a Domain Name System or enable a NetBIOS name, you can type another name, such as "SharedPrinter" instead of the IP address.

- For example:

http://SharedPrinter

If you enable a NetBIOS name, you can also use the node name.

- For example:

http://brnxxxxxxxxxxxx

The NetBIOS name can be found in the Network Configuration Report.

- For Macintosh, access Web Based Management by clicking the machine's icon on the **Status Monitor** screen.

3. No password is required by default. Type a password if you have set one, and then click .
4. Click the **Network** tab.
5. Click the **Security** tab.
6. Click **CA Certificate**.
7. Click **Import CA Certificate**.
8. Browse to the file you want to import.
9. Click **Submit**.



Related Information

- [Import and Export a CA Certificate](#)

Export a CA Certificate

1. Start your web browser.
2. Type "http://machine's IP address" in your browser's address bar (where "machine's IP address" is the machine's IP address).

For example:

http://192.168.1.2



- If you are using a Domain Name System or enable a NetBIOS name, you can type another name, such as "SharedPrinter" instead of the IP address.

- For example:

http://SharedPrinter

If you enable a NetBIOS name, you can also use the node name.

- For example:

http://brnxxxxxxxxxxxx

The NetBIOS name can be found in the Network Configuration Report.

- For Macintosh, access Web Based Management by clicking the machine's icon on the **Status Monitor** screen.

3. No password is required by default. Type a password if you have set one, and then click .
4. Click the **Network** tab.
5. Click the **Security** tab.
6. Click **CA Certificate**.
7. Select the certificate you want to export and click **Export**.
8. Click **Submit**.
9. Click **Save**.
10. Specify where on your computer you want to save the exported certificate, and save it.



Related Information

- [Import and Export a CA Certificate](#)

Manage Multiple Certificates

The multiple certificate feature allows you to use Web Based Management to manage each certificate installed on your machine. In Web Based Management, navigate to the **Certificate** or **CA Certificate** screen to view certificate content, delete, or export your certificates.

	Maximum Number of Certificates Stored UP on Brother Machine
Self-signed Certificate or Certificate Issued by a CA	5
CA Certificate	6

We recommend storing one less certificate than allowed, reserving an empty spot in case of certificate expiration. When a certificate expires, import a new certificate into the reserved spot, and then delete the expired certificate. This ensures that you avoid configuration failure.



- When you use HTTPS/IPPS, or IEEE 802.1x, you must select which certificate you are using.
- When you use SSL for SMTP communications, you do not have to choose the certificate. The necessary certificate will be chosen automatically.



Related Information

- [Certificates and Web Based Management](#)

Manage Your Network Machine Securely Using Web Based Management

To manage your network machine securely, you must use management utilities with security protocols.

We recommend using the HTTPS protocol for secure management. To use this protocol, HTTPS must be enabled on your machine.



- The HTTPS protocol is enabled by default.
- You can change the HTTPS protocol settings using the Web Based Management screen.

1. Start your web browser.
2. Type "https://Common Name" in your browser's address bar (where "Common Name" is the Common Name that you assigned to the certificate; this could be your IP address, node name, or domain name).
3. No password is required by default. Type a password if you have set one, and then click .
4. You can now access the machine using HTTPS.



- If you use the SNMPv3 protocol, follow the steps below.
- You can also change the SNMP settings by using BRAdmin Professional 3.

5. Click the **Network** tab.
6. Click **Protocol**.
7. Make sure the **SNMP** setting is enabled, and then click **Advanced Settings**.
8. Configure the SNMP settings.

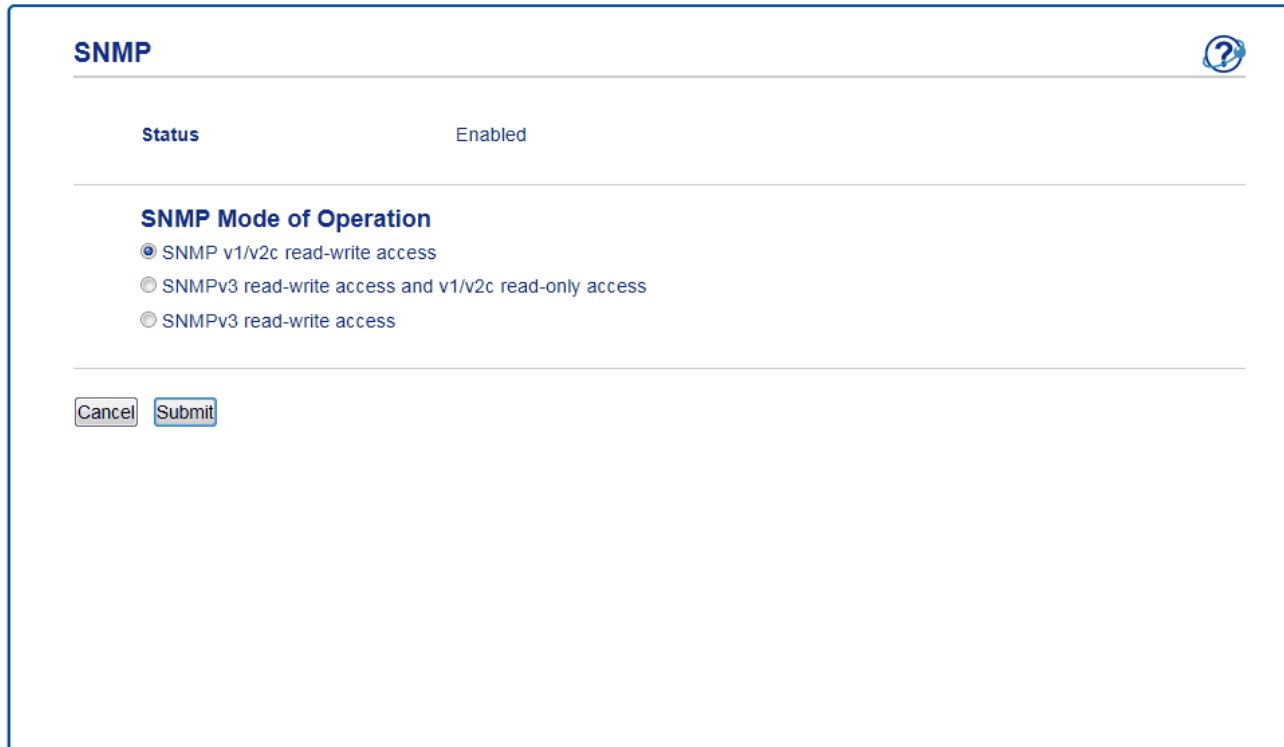

SNMP 

Status Enabled

SNMP Mode of Operation

SNMP v1/v2c read-write access

SNMPv3 read-write access and v1/v2c read-only access

SNMPv3 read-write access

There are three options for **SNMP Mode of Operation**.

- **SNMP v1/v2c read-write access**
In this mode, the print server uses version 1 and version 2c of the SNMP protocol. You can use all Brother applications in this mode. However, it is not secure since it will not authenticate the user, and data will not be encrypted.
- **SNMPv3 read-write access and v1/v2c read-only access**

In this mode, the print server uses the read-write access of version 3 and the read-only access of version 1 and version 2c of the SNMP protocol.



When you use **SNMPv3 read-write access and v1/v2c read-only access** mode, some Brother applications (such as BRAdmin Light) that access the print server do not work correctly since they authorize the read-only access of version 1 and version 2c. If you want to use all applications, we recommend using **SNMP v1/v2c read-write access** mode.

- **SNMPv3 read-write access**

In this mode, the print server uses version 3 of the SNMP protocol. If you want to manage the print server securely, use this mode.



When you use **SNMPv3 read-write access** mode, note the following:

- You can use only BRAdmin Professional 3 or Web Based Management to manage the print server.
- Except for BRAdmin Professional 3, all applications that use SNMPv1/v2c will be restricted. To allow the use of SNMPv1/v2c applications, use **SNMPv3 read-write access and v1/v2c read-only access** or **SNMP v1/v2c read-write access** mode.

9. Click **Submit**.



Related Information

- [Manage Your Network Machine Securely Using SSL/TLS](#)

Manage Your Network Machine Securely Using BRAdmin Professional 3 (Windows®)

To use BRAdmin Professional 3 utility, you must:

- Use the latest version of BRAdmin Professional 3. Go to your model's **Downloads** page on the Brother Solutions Center at support.brother.com.
- Use Web Based Management with the HTTPS protocol if you use BRAdmin Professional 3 and Web Based Management together.
- Use a different password in each group if you are managing a mixed group of older and newer print servers with BRAdmin Professional 3. This will ensure security is maintained on the newer print servers.



- "Older versions of BRAdmin" refer to BRAdmin Professional older than Ver. 2.80 and BRAdmin Light for Macintosh older than Ver.1.10.
- "Older print servers" refer to NC-2000 series, NC-2100p, NC-3100h, NC-3100s, NC-4100h, NC-5100h, NC-5200h, NC-6100h, NC-6200h, NC-6300h, NC-6400h, NC-8000, NC-100h, NC-110h, NC-120w, NC-130h, NC-140w, NC-8100h, NC-9100h, NC-7100w, NC-7200w and NC-2200w.



Related Information

- [Manage Your Network Machine Securely Using SSL/TLS](#)

Print Documents Securely Using SSL/TLS

To print documents securely with IPP protocol, use the IPPS protocol.

1. Start your web browser.
2. Type "http://machine's IP address" in your browser's address bar (where "machine's IP address" is the machine's IP address).

For example:

http://192.168.1.2



- If you are using a Domain Name System or enable a NetBIOS name, you can type another name, such as "SharedPrinter" instead of the IP address.

- For example:

http://SharedPrinter

If you enable a NetBIOS name, you can also use the node name.

- For example:

http://brnxxxxxxxxxxxx

The NetBIOS name can be found in the Network Configuration Report.

- For Macintosh, access Web Based Management by clicking the machine's icon on the **Status Monitor** screen.

3. No password is required by default. Type a password if you have set one, and then click .
4. Click the **Network** tab.
5. Click **Protocol**. Make sure the **IPP** check box is selected.



- If the **IPP** check box is not selected, select the **IPP** check box, and then click **Submit**.

Restart your machine to activate the configuration.

After the machine restarts, return to the machine's web page, click the **Network** tab, and then click **Protocol**.

6. Click **HTTP Server Settings**.
7. Select the **HTTPS(Port443)** check box in the **IPP**, and then click **Submit**.
8. Restart your machine to activate the configuration.

Communication using IPPS cannot prevent unauthorized access to the print server.



Related Information

- [Manage Your Network Machine Securely Using SSL/TLS](#)

Manage Your Network Machine Securely Using IPsec

- [Introduction to IPsec](#)
- [Configure IPsec Using Web Based Management](#)
- [Configure an IPsec Address Template Using Web Based Management](#)
- [Configure an IPsec Template Using Web Based Management](#)

Introduction to IPsec

IPsec (Internet Protocol Security) is a security protocol that uses an optional Internet Protocol function to prevent manipulation and ensure the confidentiality of data transmitted as IP packets. IPsec encrypts data carried over the network, such as print data sent from computers to a printer. Because the data is encrypted at the network layer, applications that employ a higher-level protocol use IPsec even if the user is not aware of its use.

IPsec supports the following functions:

- IPsec transmissions

According to the IPsec setting conditions, the network-connected computer sends data to and receives data from the specified device using IPsec. When the devices start communicating using IPsec, keys are exchanged using Internet Key Exchange (IKE) first, and then the encrypted data is transmitted using the keys.

In addition, IPsec has two operation modes: the Transport mode and Tunnel mode. The Transport mode is used mainly for communication between devices and the Tunnel mode is used in environments such as a Virtual Private Network (VPN).



For IPsec transmissions, the following conditions are necessary:

- A computer that can communicate using IPsec is connected to the network.
 - Your Brother machine is configured for IPsec communication.
 - The computer connected to your Brother machine is configured for IPsec connections.
-

- IPsec settings

The settings that are necessary for connections using IPsec. These settings can be configured using Web Based Management.



To configure the IPsec settings, you must use the browser on a computer that is connected to the network.



Related Information

- [Manage Your Network Machine Securely Using IPsec](#)
-

Configure IPsec Using Web Based Management

The IPsec connection conditions are comprised of two **Template** types: **Address** and **IPsec**. You can configure up to 10 connection conditions.

1. Start your web browser.
2. Type "http://machine's IP address" in your browser's address bar (where "machine's IP address" is the machine's IP address).

For example:

http://192.168.1.2

3. No password is required by default. Type a password if you have set one, and then click .
4. Click the **Network** tab.
5. Click the **Security** tab.
6. Click the **IPsec** menu in the left navigation bar.

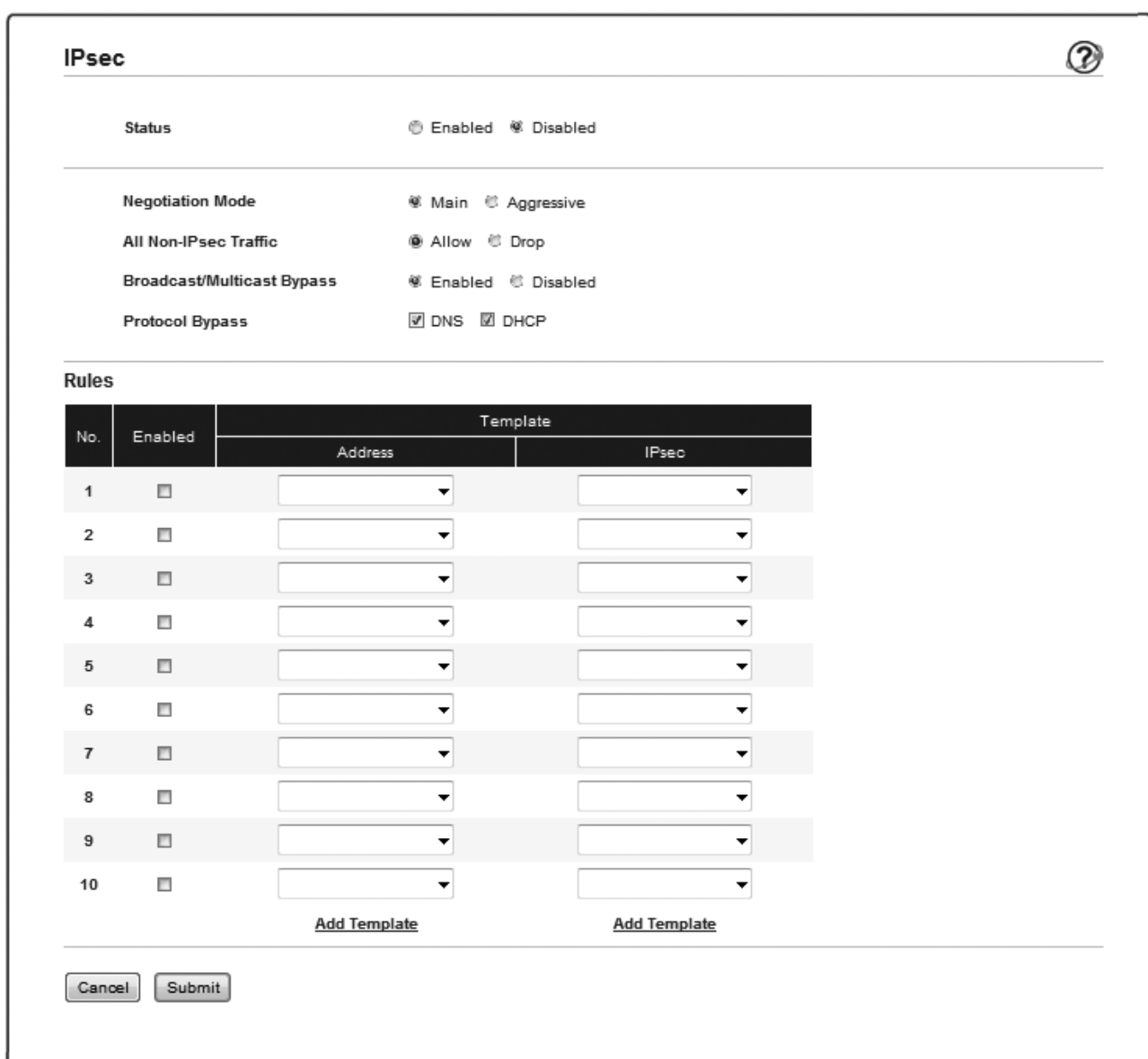

IPsec 

Status Enabled Disabled

Negotiation Mode Main Aggressive

All Non-IPsec Traffic Allow Drop

Broadcast/Multicast Bypass Enabled Disabled

Protocol Bypass DNS DHCP

Rules

No.	Enabled	Template	
		Address	IPsec
1	<input type="checkbox"/>	<input type="text"/>	<input type="text"/>
2	<input type="checkbox"/>	<input type="text"/>	<input type="text"/>
3	<input type="checkbox"/>	<input type="text"/>	<input type="text"/>
4	<input type="checkbox"/>	<input type="text"/>	<input type="text"/>
5	<input type="checkbox"/>	<input type="text"/>	<input type="text"/>
6	<input type="checkbox"/>	<input type="text"/>	<input type="text"/>
7	<input type="checkbox"/>	<input type="text"/>	<input type="text"/>
8	<input type="checkbox"/>	<input type="text"/>	<input type="text"/>
9	<input type="checkbox"/>	<input type="text"/>	<input type="text"/>
10	<input type="checkbox"/>	<input type="text"/>	<input type="text"/>

[Add Template](#) [Add Template](#)

7. In the **Status** field, enable or disable IPsec.
8. Select **Negotiation Mode** for IKE Phase 1.

IKE is a protocol that is used to exchange encryption keys in order to carry out encrypted communication using IPsec.

In **Main** mode, the processing speed is slow, but the security is high. In **Aggressive** mode, the processing speed is faster than **Main** mode, but the security is lower.

9. In the **All Non-IPsec Traffic** field, select the action to be taken for non-IPsec packets.

When using Web Services, you must select **Allow** for **All Non-IPsec Traffic**. If you select **Drop**, Web Services cannot be used.

10. In the **Broadcast/Multicast Bypass** field, select **Enabled** or **Disabled**.

11. In the **Protocol Bypass** field, select the check box for the option or options you want.

12. In the **Rules** table, select the **Enabled** check box to activate the template.

When you select multiple check boxes, the lower numbered check boxes have priority if the settings for the selected check boxes conflict.

13. Click on the corresponding drop-down list to select the **Address Template** that is used for the IPsec connection conditions.

To add an **Address Template**, click **Add Template**.

14. Click on the corresponding drop-down list to select the **IPsec Template** that is used for the IPsec connection conditions.

To add an **IPsec Template**, click **Add Template**.

15. Click **Submit**.

If the machine must be restarted to register the new settings, the restart confirmation screen will appear.

If there is a blank item in the template you enabled in the **Rules** table, an error message appears. Confirm your choices and click **Submit** again.



Related Information

- [Manage Your Network Machine Securely Using IPsec](#)
-

Configure an IPsec Address Template Using Web Based Management

1. Start your web browser.
2. Type "http://machine's IP address" in your browser's address bar (where "machine's IP address" is the machine's IP address).

For example:

http://192.168.1.2

3. No password is required by default. Type a password if you have set one, and then click .
4. Click the **Network** tab.
5. Click the **Security** tab.
6. Click the **IPsec Address Template** menu in the left navigation bar.

The Template List appears, displaying 10 Address Templates.

Click the **Delete** button to delete an **Address Template**. When an **Address Template** is in use, it cannot be deleted.

7. Click the **Address Template** that you want to create. The **IPsec Address Template** appears.

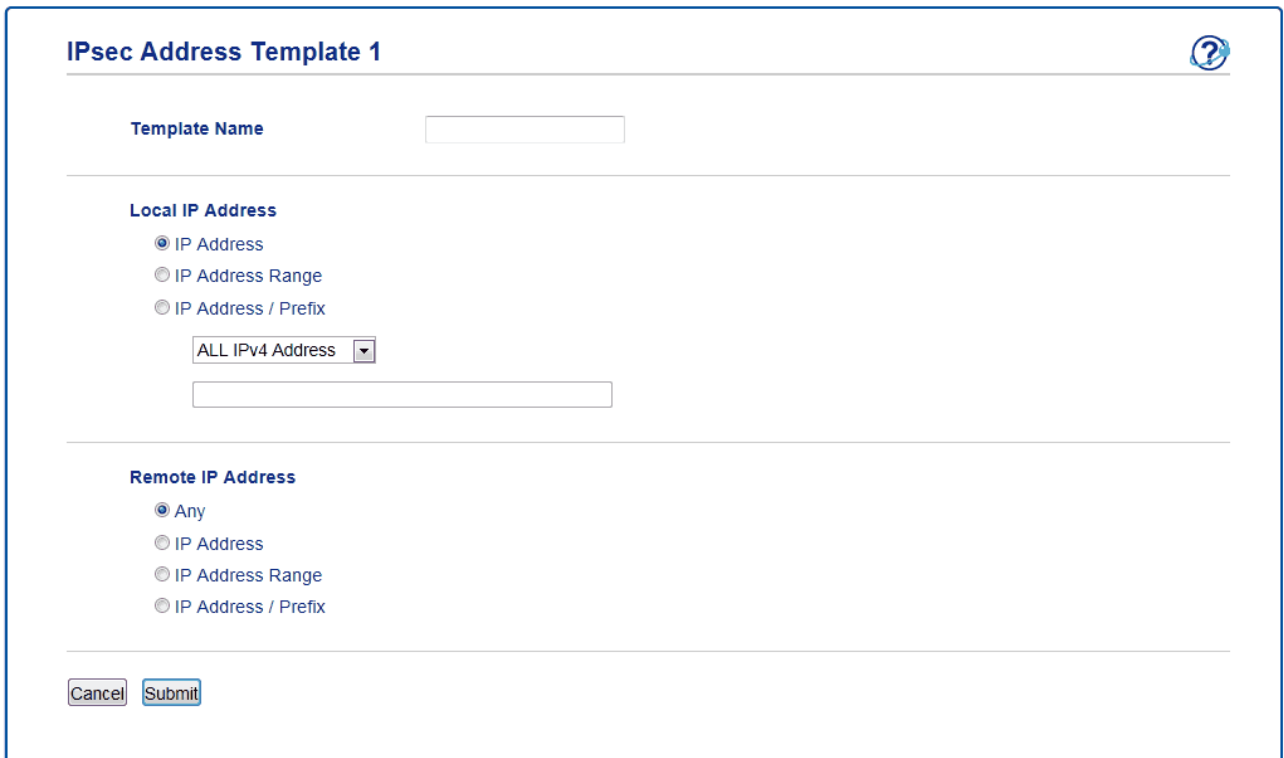

The screenshot shows a web form titled "IPsec Address Template 1" with a help icon in the top right. The form is divided into sections:

- Template Name:** A text input field.
- Local IP Address:** A section with three radio button options: "IP Address" (selected), "IP Address Range", and "IP Address / Prefix". Below these is a dropdown menu currently set to "ALL IPv4 Address" and an empty text input field.
- Remote IP Address:** A section with four radio button options: "Any" (selected), "IP Address", "IP Address Range", and "IP Address / Prefix".

At the bottom of the form are "Cancel" and "Submit" buttons.

8. In the **Template Name** field, type a name for the template (up to 16 characters).
9. Select a **Local IP Address** option to specify the IP address conditions for the sender:
 - **IP Address**
Specify the IP address. Select **ALL IPv4 Address**, **ALL IPv6 Address**, **ALL Link Local IPv6**, or **Custom** from the drop-down list.
If you select **Custom** from the drop-down list, type the IP address (IPv4 or IPv6) in the text box.
 - **IP Address Range**
Type the starting and ending IP addresses for the IP address range in the text boxes. If the starting and ending IP addresses are not standardized to IPv4 or IPv6, or the ending IP address is smaller than the starting address, an error will occur.
 - **IP Address / Prefix**
Specify the IP address using CIDR notation.

For example: 192.168.1.1/24

Because the prefix is specified in the form of a 24-bit subnet mask (255.255.255.0) for 192.168.1.1, the addresses 192.168.1.xxx are valid.

10. Select a **Remote IP Address** option to specify the IP address conditions for the recipient:

- **Any**

If you select **Any**, all IP addresses are enabled.

- **IP Address**

Type the specified IP address (IPv4 or IPv6) in the text box.

- **IP Address Range**

Type the starting and ending IP addresses for the IP address range. If the starting and ending IP addresses are not standardized to IPv4 or IPv6, or the ending IP address is smaller than the starting address, an error will occur.

- **IP Address / Prefix**

Specify the IP address using CIDR notation.

For example: 192.168.1.1/24

Because the prefix is specified in the form of a 24-bit subnet mask (255.255.255.0) for 192.168.1.1, the addresses 192.168.1.xxx are valid.

11. Click **Submit**.



When you change the settings for the template currently in use, restart your machine to active the configuration.



Related Information

- [Manage Your Network Machine Securely Using IPsec](#)
-

Configure an IPsec Template Using Web Based Management

1. Start your web browser.
2. Type "http://machine's IP address" in your browser's address bar (where "machine's IP address" is the machine's IP address).
For example:
http://192.168.1.2
3. No password is required by default. Type a password if you have set one, and then click .
4. Click the **Network** tab.
5. Click the **Security** tab.
6. Click **IPsec Template** in the left navigation bar.
The Template List appears, displaying 10 IPsec Templates.
Click the **Delete** button to delete an **IPsec Template**. When an **IPsec Template** is in use, it cannot be deleted.
7. Click **IPsec Template** that you want to create. The **IPsec Template** screen appears. The configuration fields differ based on the **Use Prefixed Template** and **Internet Key Exchange (IKE)** you select.
8. In the **Template Name** field, type a name for the template (up to 16 characters).
9. If you selected **Custom** in the **Use Prefixed Template** drop-down list, select the **Internet Key Exchange (IKE)** options, and then change the settings if needed.
10. Click **Submit**.

IPsec Template 1



Template Name
Use Prefixed Template

Internet Key Exchange (IKE) IKEv1

Authentication Type

Diffie-Hellman Group
Group14
Encryption
AES-CBC 256
Hash
SHA256
SHA512
SA Lifetime
(240 – 63072000)

(10 – 2097152)

Encapsulating Security

Protocol
Encryption
AES-CBC 256
Hash
SHA256
SHA512
SA Lifetime
(240 – 63072000)

(10 – 2097152)
Encapsulation Mode Transport Tunnel
Remote Router IP-Address

Perfect Forward Secrecy (PFS) Enabled Disabled

Authentication Method Pre-Shared Key
 Certificates

Pre-Shared Key

Local

ID Type
ID

Remote

ID Type
ID

[Certificate>>](#)



Related Information

- Manage Your Network Machine Securely Using IPsec
- IKEv1 Settings for an IPsec Template
- IKEv2 Settings for an IPsec Template
- Manual Settings for an IPsec Template

IKEv1 Settings for an IPsec Template

IPsec Template 1 ?

Template Name

Use Prefixed Template

Internet Key Exchange (IKE) IKEv1 IKEv2 Manual

Authentication Type

Diffie-Hellman Group

Encryption

Hash

SA Lifetime second(s)
(240 – 63072000)

KByte
(10 – 2097152)

Encapsulating Security

Protocol ESP AH AH+ESP

Encryption

Hash

SA Lifetime second(s)
(120 – 4233600)

KByte
(10 – 4194304)

Encapsulation Mode Transport Tunnel

Remote Router IP-Address

Perfect Forward Secrecy (PFS) Enabled Disabled

Authentication Method Pre-Shared Key Certificates

Pre-Shared Key

Local

ID Type

ID

Remote

ID Type

ID

[Certificate>>](#)

Template Name

Type a name for the template (up to 16 characters).

Use Prefixed Template

Select **Custom**, **IKEv1 High Security** or **IKEv1 Medium Security**. The setting items are different depending on the selected template.



The default template differs depending on whether you chose **Main** or **Aggressive** for **Negotiation Mode** on the **IPsec** configuration screen.

Internet Key Exchange (IKE)

IKE is a communication protocol that is used to exchange encryption keys in order to carry out encrypted communication using IPsec. To carry out encrypted communication for that time only, the encryption algorithm that is necessary for IPsec is determined and the encryption keys are shared. For IKE, the encryption keys are exchanged using the Diffie-Hellman key exchange method, and encrypted communication that is limited to IKE is carried out.

If you selected **Custom** in **Use Prefixed Template**, select **IKEv1**.

Authentication Type

Configure the IKE authentication and encryption.

- **Diffie-Hellman Group**

This key exchange method allows secret keys to be securely exchanged over an unprotected network. The Diffie-Hellman key exchange method uses a discrete logarithm problem, not the secret key, to send and receive open information that was generated using a random number and the secret key.

Select **Group1**, **Group2**, **Group5**, or **Group14**.

- **Encryption**

Select **DES**, **3DES**, **AES-CBC 128**, or **AES-CBC 256**.

- **Hash**

Select **MD5**, **SHA1**, **SHA256**, **SHA384** or **SHA512**.

- **SA Lifetime**

Specify the IKE SA lifetime.

Type the time (seconds) and number of kilobytes (KByte).

Encapsulating Security

- **Protocol**

Select **ESP**, **AH** or **AH+ESP**.



- ESP is a protocol for carrying out encrypted communication using IPsec. ESP encrypts the payload (communicated contents) and adds additional information. The IP packet is comprised of the header and the encrypted payload, which follows the header. In addition to the encrypted data, the IP packet also includes information regarding the encryption method and encryption key, the authentication data, and so on.

- AH is part of the IPsec protocol that authenticates the sender and prevents manipulation (ensures the completeness) of the data. In the IP packet, the data is inserted immediately after the header. In addition, the packets include hash values, which are calculated using an equation from the communicated contents, secret key, and so on, in order to prevent the falsification of the sender and manipulation of the data. Unlike ESP, the communicated contents are not encrypted, and the data is sent and received as plain text.

- **Encryption**

Select **DES**, **3DES**, **AES-CBC 128**, or **AES-CBC 256**. The encryption can be selected only when **ESP** is selected in **Protocol**.

- **Hash**

Select **None**, **MD5**, **SHA1**, **SHA256**, **SHA384**, or **SHA512**.

When **AH+ESP** is selected in **Protocol**, select each protocol for **Hash(ESP)** and **Hash(AH)**.

- **SA Lifetime**

Specify the IPsec SA lifetime.

Type the time (seconds) and number of kilobytes (KByte) before the IPsec SA will expire.

- **Encapsulation Mode**

Select **Transport** or **Tunnel**.

- **Remote Router IP-Address**

Type the IP address (IPv4 or IPv6) of the remote router. Enter this information only when the **Tunnel** mode is selected.



SA (Security Association) is an encrypted communication method using IPsec or IPv6 that exchanges and shares information, such as the encryption method and encryption key, in order to establish a secure communication channel before communication begins. SA may also refer to a virtual encrypted communication channel that has been established. The SA used for IPsec establishes the encryption method, exchanges the keys, and carries out mutual authentication according to the IKE (Internet Key Exchange) standard procedure. In addition, the SA is updated periodically.

Perfect Forward Secrecy (PFS)

PFS does not derive keys from previous keys that were used to encrypt messages. In addition, if a key that is used to encrypt a message was derived from a parent key, that parent key is not used to derive other keys. Therefore, even if a key is compromised, the damage will be limited only to the messages that were encrypted using that key.

Select **Enabled** or **Disabled**.

Authentication Method

Select the authentication method. Select **Pre-Shared Key** or **Certificates**.

Pre-Shared Key

When encrypting communication, the encryption key is exchanged and shared beforehand using another channel.

If you selected **Pre-Shared Key** for the **Authentication Method**, type the **Pre-Shared Key** (up to 32 characters).

- **Local/ID Type/ID**

Select the sender's ID type, and then type the ID.

Select **IPv4 Address**, **IPv6 Address**, **FQDN**, **E-mail Address**, or **Certificate** for the type.

If you select **Certificate**, type the common name of the certificate in the **ID** field.

- **Remote/ID Type/ID**

Select the recipient's ID type, and then type the ID.

Select **IPv4 Address**, **IPv6 Address**, **FQDN**, **E-mail Address**, or **Certificate** for the type.

If you select **Certificate**, type the common name of the certificate in the **ID** field.

Certificate

If you selected **Certificates** for **Authentication Method**, select the certificate.



You can select only the certificates that were created using the **Certificate** page of Web Based Management's Security configuration screen.



Related Information

- [Configure an IPsec Template Using Web Based Management](#)
-

IKEv2 Settings for an IPsec Template

IPsec Template 1 ?

Template Name

Use Prefixed Template

Internet Key Exchange (IKE) IKEv1 IKEv2 Manual

Authentication Type

Diffie-Hellman Group Group1 Group2 Group5 Group14

Encryption DES 3DES AES-CBC 128
 AES-CBC 256

Hash MD5 SHA1 SHA256 SHA384
 SHA512

SA Lifetime second(s)
(240 – 63072000)

KByte
(10 – 2097152)

Encapsulating Security

Protocol ESP

Encryption DES 3DES AES-CBC 128
 AES-CBC 256

Hash MD5 SHA1 SHA256 SHA384
 SHA512

SA Lifetime second(s)
(120 – 4233600)

KByte
(10 – 4194304)

Encapsulation Mode Transport Tunnel

Remote Router IP-Address

Perfect Forward Security (PFS) Enabled Disabled

Authentication Method Pre-Shared Key
 Certificates
 EAP - MD5
 EAP - MS-CHAPv2

Pre-Shared Key

Local

ID Type

ID

Remote

ID Type

ID

[Certificate>>](#)

Template Name

Type a name for the template (up to 16 characters).

Use Prefixed Template

Select **Custom**, **IKEv2 High Security**, or **IKEv2 Medium Security**. The setting items are different depending on the selected template.

Internet Key Exchange (IKE)

IKE is a communication protocol that is used to exchange encryption keys in order to carry out encrypted communication using IPsec. To carry out encrypted communication for that time only, the encryption algorithm that is necessary for IPsec is determined and the encryption keys are shared. For IKE, the encryption keys are exchanged using the Diffie-Hellman key exchange method, and encrypted communication that is limited to IKE is carried out.

If you selected **Custom** in **Use Prefixed Template**, select **IKEv2**.

Authentication Type

Configure the IKE authentication and encryption.

- **Diffie-Hellman Group**

This key exchange method allows secret keys to be securely exchanged over an unprotected network. The Diffie-Hellman key exchange method uses a discrete logarithm problem, not the secret key, to send and receive open information that was generated using a random number and the secret key.

Select **Group1**, **Group2**, **Group5**, or **Group14**.

- **Encryption**

Select **DES**, **3DES**, **AES-CBC 128**, or **AES-CBC 256**.

- **Hash**

Select **MD5**, **SHA1**, **SHA256**, **SHA384** or **SHA512**.

- **SA Lifetime**

Specify the IKE SA lifetime.

Type the time (seconds) and number of kilobytes (KByte).

Encapsulating Security

- **Protocol**

Select **ESP**.



ESP is a protocol for carrying out encrypted communication using IPsec. ESP encrypts the payload (communicated contents) and adds additional information. The IP packet is comprised of the header and the encrypted payload, which follows the header. In addition to the encrypted data, the IP packet also includes information regarding the encryption method and encryption key, the authentication data, and so on.

- **Encryption**

Select **DES**, **3DES**, **AES-CBC 128**, or **AES-CBC 256**.

- **Hash**

Select **MD5**, **SHA1**, **SHA256**, **SHA384**, or **SHA512**.

- **SA Lifetime**

Specify the IPsec SA lifetime.

Type the time (seconds) and number of kilobytes (KByte) before the IPsec SA will expire.

- **Encapsulation Mode**

Select **Transport** or **Tunnel**.

- **Remote Router IP-Address**

Type the IP address (IPv4 or IPv6) of the remote router. Enter this information only when the **Tunnel** mode is selected.



SA (Security Association) is an encrypted communication method using IPsec or IPv6 that exchanges and shares information, such as the encryption method and encryption key, in order to establish a secure communication channel before communication begins. SA may also refer to a virtual encrypted communication channel that has been established. The SA used for IPsec establishes the encryption method, exchanges the keys, and carries out mutual authentication according to the IKE (Internet Key Exchange) standard procedure. In addition, the SA is updated periodically.

Perfect Forward Secrecy (PFS)

PFS does not derive keys from previous keys that were used to encrypt messages. In addition, if a key that is used to encrypt a message was derived from a parent key, that parent key is not used to derive other keys. Therefore, even if a key is compromised, the damage will be limited only to the messages that were encrypted using that key.

Select **Enabled** or **Disabled**.

Authentication Method

Select the authentication method. Select **Pre-Shared Key**, **Certificates**, **EAP - MD5**, or **EAP - MS-CHAPv2**.

Pre-Shared Key

When encrypting communication, the encryption key is exchanged and shared beforehand using another channel.

If you selected **Pre-Shared Key** for the **Authentication Method**, type the **Pre-Shared Key** (up to 32 characters).

- **Local/ID Type/ID**

Select the sender's ID type, and then type the ID.

Select **IPv4 Address**, **IPv6 Address**, **FQDN**, **E-mail Address**, or **Certificate** for the type.

If you select **Certificate**, type the common name of the certificate in the **ID** field.

- **Remote/ID Type/ID**

Select the recipient's ID type, and then type the ID.

Select **IPv4 Address**, **IPv6 Address**, **FQDN**, **E-mail Address**, or **Certificate** for the type.

If you select **Certificate**, type the common name of the certificate in the **ID** field.

Certificate

If you selected **Certificates** for **Authentication Method**, select the certificate.



You can select only the certificates that were created using the **Certificate** page of Web Based Management's Security configuration screen.

EAP

EAP is an authentication protocol that is an extension of PPP. By using EAP with IEEE802.1x, a different key is used for user authentication during each session.

The following settings are necessary only when **EAP - MD5** or **EAP - MS-CHAPv2** is selected in **Authentication Method**:

- **Mode**

Select **Server-Mode** or **Client-Mode**.

- **Certificate**

Select the certificate.

- **User Name**

Type the user name (up to 32 characters).

- **Password**

Type the password (up to 32 characters). The password must be entered two times for confirmation.



Related Information

- [Configure an IPsec Template Using Web Based Management](#)
-

Manual Settings for an IPsec Template

IPsec Template 1 ?

Template Name	<input type="text"/>
Use Prefixed Template	<input type="text" value="Custom"/>

Internet Key Exchange (IKE) IKEv1 IKEv2 Manual

Authentication Key (ESP, AH)

In	<input type="text"/>
Out	<input type="text"/>

Code key (ESP)

In	<input type="text"/>
Out	<input type="text"/>

SPI

In	<input type="text" value="256"/>
Out	<input type="text" value="256"/>

Encapsulating Security

Protocol	<input checked="" type="radio"/> ESP <input type="radio"/> AH
Encryption	<input type="text" value="DES"/>
Hash	<input type="text" value="MD5"/>
SA Lifetime	<input type="text" value="43200"/> second(s) <small>(120 - 4233600)</small>
	<input type="text" value="65536"/> KByte <small>(10 - 4194304)</small>
Encapsulation Mode	<input checked="" type="radio"/> Transport <input type="radio"/> Tunnel
Remote Router IP-Address	<input type="text"/>

[Certificate](#)

Template Name

Type a name for the template (up to 16 characters).

Use Prefixed Template

Select **Custom**.

Internet Key Exchange (IKE)

IKE is a communication protocol that is used to exchange encryption keys in order to carry out encrypted communication using IPsec. To carry out encrypted communication for that time only, the encryption algorithm that is necessary for IPsec is determined and the encryption keys are shared. For IKE, the encryption keys are exchanged using the Diffie-Hellman key exchange method, and encrypted communication that is limited to IKE is carried out.

Select **Manual**.

Authentication Key (ESP,AH)

Specify the key to use for authentication. Type the **In/Out** values.

These settings are necessary when **Custom** is selected for **Use Prefixed Template**, **Manual** is selected for **Internet Key Exchange (IKE)**, and a setting other than **None** is selected for **Hash** for **Encapsulating Security** section.



The number of characters you can set differs depending on the setting you chose for **Hash** in the **Encapsulating Security** section.

If the length of the specified authentication key is different than the selected hash algorithm, an error will occur.

- **MD5**: 128 bits (16 bytes)
- **SHA1**: 160 bits (20 bytes)
- **SHA256**: 256 bits (32 bytes)
- **SHA384**: 384 bits (48 bytes)
- **SHA512**: 512 bits (64 bytes)

When you specify the key in ASCII Code, enclose the characters in double quotation marks ("").

Code key (ESP)

Specify the key to use for encryption. Type the **In/Out** values.

These settings are necessary when **Custom** is selected in **Use Prefixed Template**, **Manual** is selected in **Internet Key Exchange (IKE)**, and **ESP** is selected in **Protocol** in **Encapsulating Security**.



The number of characters you can set differs depending on the setting you chose for **Encryption** in the **Encapsulating Security** section.

If the length of the specified code key is different than the selected encryption algorithm, an error will occur.

- **DES**: 64 bits (8 bytes)
- **3DES**: 192 bits (24 bytes)
- **AES-CBC 128**: 128 bits (16 bytes)
- **AES-CBC 256**: 256 bits (32 bytes)

When you specify the key in ASCII Code, enclose the characters in double quotation marks ("").

SPI

These parameters are used to identify security information. Generally, a host has multiple Security Associations (SAs) for several types of IPsec communication. Therefore, it is necessary to identify the applicable SA when an IPsec packet is received. The SPI parameter, which identifies the SA, is included in the Authentication Header (AH) and Encapsulating Security Payload (ESP) header.

These settings are necessary when **Custom** is selected for **Use Prefixed Template**, and **Manual** is selected for **Internet Key Exchange (IKE)**.

Enter the **In/Out** values. (3-10 characters)

Encapsulating Security

- **Protocol**
Select **ESP** or **AH**.



- ESP is a protocol for carrying out encrypted communication using IPsec. ESP encrypts the payload (communicated contents) and adds additional information. The IP packet is comprised of the header and the encrypted payload, which follows the header. In addition to the encrypted data, the IP packet also includes information regarding the encryption method and encryption key, the authentication data, and so on.
- AH is part of the IPsec protocol that authenticates the sender and prevents manipulation of the data (ensures the completeness of the data). In the IP packet, the data is inserted immediately after the header. In addition, the packets include hash values, which are calculated using an equation from the communicated contents, secret key, and so on, in order to prevent the falsification of the sender and manipulation of the data. Unlike ESP, the communicated contents are not encrypted, and the data is sent and received as plain text.

- **Encryption**

Select **DES**, **3DES**, **AES-CBC 128**, or **AES-CBC 256**. The encryption can be selected only when **ESP** is selected in **Protocol**.

- **Hash**

Select **None**, **MD5**, **SHA1**, **SHA256**, **SHA384**, or **SHA512**. **None** can be selected only when **ESP** is selected in **Protocol**.

- **SA Lifetime**

Specify the IKE SA lifetime.

Type the time (seconds) and number of kilobytes (KByte) before the IPsec SA will expire.

- **Encapsulation Mode**

Select **Transport** or **Tunnel**.

- **Remote Router IP-Address**

Specify the IP address (IPv4 or IPv6) of the connection destination. Enter this information only when the **Tunnel** mode is selected.



SA (Security Association) is an encrypted communication method using IPsec or IPv6 that exchanges and shares information, such as the encryption method and encryption key, in order to establish a secure communication channel before communication begins. SA may also refer to a virtual encrypted communication channel that has been established. The SA used for IPsec establishes the encryption method, exchanges the keys, and carries out mutual authentication according to the IKE (Internet Key Exchange) standard procedure. In addition, the SA is updated periodically.



Related Information

- [Configure an IPsec Template Using Web Based Management](#)
-

Send an Email Securely

- [Configure Email Sending Using Web Based Management](#)
- [Send an Email with User Authentication](#)
- [Send an Email Securely Using SSL/TLS](#)

Configure Email Sending Using Web Based Management

We recommend using Web Based Management to configure secured email sending with user authentication, or email sending using SSL/TLS.

1. Start your web browser.
2. Type "http://machine's IP address" in your browser's address bar (where "machine's IP address" is the machine's IP address).
For example:
http://192.168.1.2
3. No password is required by default. Type a password if you have set one, and then click .
4. Click the **Network** tab.
5. Click the **Protocol** menu in the left navigation bar.
6. In the **SMTP** field, click **Advanced Settings** and make sure the status of **SMTP** is **Enabled**.
7. Configure the **SMTP** settings.
 - Confirm that the email settings are correct after configuration by sending a test email.
 - If you do not know the SMTP server settings, contact your network administrator or Internet Service Provider (ISP).
8. When finished, click **Submit**.
The **Test Send E-mail Configuration** dialog box appears.
9. Follow the instructions in the dialog box to test the current settings.



Related Information

- [Send an Email Securely](#)

Send an Email with User Authentication

Your Brother machine supports the SMTP-AUTH method to send email via an email server that requires user authentication. This method prevents unauthorized users from accessing the email server.

You can use the SMTP-AUTH method for email notification and email reports.



We recommend using Web Based Management to configure the SMTP authentication.

Email Server Settings

You must configure your machine's SMTP authentication method to match the method used by your email server. For details about your email server settings, contact your network administrator or Internet Service Provider (ISP).



To enable SMTP server authentication, in the Web Based Management **SMTP** screen, under **Server Authentication Method**, you must select **SMTP-AUTH**.



Related Information

- [Send an Email Securely](#)

Send an Email Securely Using SSL/TLS

Your Brother machine supports SSL/TLS methods to send an email via an email server that requires secure SSL/TLS communication. To send email via an email server that is using SSL/TLS communication, you must configure SMTP over SSL/TLS.



We recommend using Web Based Management to configure SSL/TLS.

Verify Server Certificate

Under **SSL/TLS**, if you choose **SSL** or **TLS**, the **Verify Server Certificate** check box will be selected automatically.

SMTP

Status Enabled

Send E-mail Settings(SMTP)

Server Address

Port

Server Authentication Method None
 SMTP-AUTH

SMTP-AUTH Account Name

SMTP-AUTH Account Password

Enter password

Retype password

SSL/TLS None
 SSL
 TLS
 Verify Server Certificate

Device E-mail Address

[CA Certificate>>](#)

[E-mail report>>](#)

[Notification>>](#)



- Before you verify the server certificate, you must import the CA certificate issued by the CA that signed the server certificate. Contact your network administrator or your Internet Service Provider (ISP) to confirm if importing a CA certificate is necessary.
- If you do not need to verify the server certificate, clear the **Verify Server Certificate** check box.

Port Number

If you select **SSL**, the **Port** value will be changed to match the protocol. To change the port number manually, type the port number after you choose **SSL/TLS**.

You must configure your machine's SMTP communication method to match the method used by your email server. For details about your email server settings, contact your network administrator or your ISP.

In most cases, the secured webmail services require the following settings:

SMTP	Port	25
	Server Authentication Method	SMTP-AUTH
	SSL/TLS	TLS



Related Information

- [Send an Email Securely](#)

Use IEEE 802.1x Authentication for a Wired or a Wireless Network

- [What Is IEEE 802.1x Authentication?](#)
- [Configure IEEE 802.1x Authentication for a Wired or a Wireless Network Using Web Based Management \(Web Browser\)](#)
- [IEEE 802.1x Authentication Methods](#)

What Is IEEE 802.1x Authentication?

IEEE 802.1x is an IEEE standard for wired and wireless networks that limits access from unauthorized network devices. Your Brother machine (supplicant) sends an authentication request to a RADIUS server (Authentication server) through your access point or HUB. After your request has been verified by the RADIUS server, your machine can access the network.



Related Information

- [Use IEEE 802.1x Authentication for a Wired or a Wireless Network](#)
-

Configure IEEE 802.1x Authentication for a Wired or a Wireless Network Using Web Based Management (Web Browser)

- If you configure your machine using EAP-TLS authentication, you must install the client certificate issued by a CA before you start configuration. Contact your network administrator about the client certificate. If you have installed more than one certificate, we recommend writing down the certificate name you want to use.
- Before you verify the server certificate, you must import the CA certificate that has been issued by the CA that signed the server certificate. Contact your network administrator or your Internet Service Provider (ISP) to confirm whether a CA certificate import is necessary.



You can also configure IEEE 802.1x authentication using:

- BRAdmin Professional 3 (Wired and wireless network)
- Wireless setup wizard from the control panel (Wireless network)
- Wireless setup wizard on the installation disc (Wireless network)

1. Start your web browser.
2. Type "http://machine's IP address" in your browser's address bar (where "machine's IP address" is the machine's IP address).

For example:

http://192.168.1.2



- If you are using a Domain Name System or enable a NetBIOS name, you can type another name, such as "SharedPrinter" instead of the IP address.

- For example:

http://SharedPrinter

If you enable a NetBIOS name, you can also use the node name.

- For example:

http://brnxxxxxxxxxxxx

The NetBIOS name can be found in the Network Configuration Report.

- For Macintosh, access Web Based Management by clicking the machine's icon on the **Status Monitor** screen.

3. No password is required by default. Type a password if you have set one, and then click .
4. Click the **Network** tab.
5. Do one of the following:

Option	Description
Wired network	Click the Wired tab, and then select Wired 802.1x Authentication in the left navigation bar.
Wireless network	Click the Wireless tab, and then select Wireless (Enterprise) in the left navigation bar.

6. Configure the IEEE 802.1x authentication settings.



- To enable IEEE 802.1x authentication for wired networks, select **Enabled** for **Wired 802.1x status** on the **Wired 802.1x Authentication** page.
- If you are using **EAP-TLS** authentication, you must select the client certificate that has been installed (shown with certificate name) for verification from the **Client Certificate** drop-down list.
- If you select **EAP-FAST**, **PEAP**, **EAP-TTLS**, or **EAP-TLS** authentication, select the verification method from the **Server Certificate Verification** drop-down list. Verify the server certificate using the CA certificate, imported to the machine in advance, that has been issued by the CA that signed the server certificate.

Select one of the following verification methods from the **Server Certificate Verification** drop-down list:

Option	Description
No Verification	The server certificate can always be trusted. The verification is not performed.
CA Cert.	The verification method to check the CA reliability of the server certificate, using the CA certificate that has been issued by the CA that signed the server certificate.
CA Cert. + ServerID	The verification method to check the common name ¹ value of the server certificate, in addition to the CA reliability of the server certificate.

7. When finished with configuration, click **Submit**.

For wired networks: After configuring, connect your machine to the IEEE 802.1x supported network. After a few minutes, print the Network Configuration Report to check the **<Wired IEEE 802.1x>** Status.

Option	Description
Success	The wired IEEE 802.1x function is enabled and the authentication was successful.
Failed	The wired IEEE 802.1x function is enabled; however, the authentication failed.
Off	The wired IEEE 802.1x function is not available.



Related Information

- [Use IEEE 802.1x Authentication for a Wired or a Wireless Network](#)

¹ The common name verification compares the common name of the server certificate to the character string configured for the **Server ID**. Before you use this method, contact your system administrator about the server certificate's common name and then configure **Server ID**.

IEEE 802.1x Authentication Methods

LEAP (Wireless network)

Lightweight Extensible Authentication Protocol (LEAP) is a proprietary EAP method developed by Cisco Systems, Inc., which uses a user ID and password for authentication.

EAP-FAST

Extensible Authentication Protocol-Flexible Authentication via Secured Tunneling (EAP-FAST) has been developed by Cisco Systems, Inc., which uses a user ID and password for authentication, and symmetric key algorithms to achieve a tunneled authentication process.

The Brother machine supports the following inner authentication methods:

- EAP-FAST/NONE
- EAP-FAST/MS-CHAPv2
- EAP-FAST/GTC

EAP-MD5 (Wired network)

Extensible Authentication Protocol-Message Digest Algorithm 5 (EAP-MD5) uses a user ID and password for challenge-response authentication.

PEAP

Protected Extensible Authentication Protocol (PEAP) is a version of EAP method developed by Cisco Systems, Inc., Microsoft® Corporation and RSA Security. PEAP creates an encrypted Secure Sockets Layer (SSL)/Transport Layer Security (TLS) tunnel between a client and an authentication server, for sending a user ID and password. PEAP provides mutual authentication between the server and the client.

The Brother machine supports the following inner authentications:

- PEAP/MS-CHAPv2
- PEAP/GTC

EAP-TTLS

Extensible Authentication Protocol-Tunneled Transport Layer Security (EAP-TTLS) has been developed by Funk Software and Certicom. EAP-TTLS creates a similar encrypted SSL tunnel to PEAP, between a client and an authentication server, for sending a user ID and password. EAP-TTLS provides mutual authentication between the server and the client.

The Brother machine supports the following inner authentications:

- EAP-TTLS/CHAP
- EAP-TTLS/MS-CHAP
- EAP-TTLS/MS-CHAPv2
- EAP-TTLS/PAP

EAP-TLS

Extensible Authentication Protocol-Transport Layer Security (EAP-TLS) requires digital certificate authentication both at a client and an authentication server.



Related Information

- [Use IEEE 802.1x Authentication for a Wired or a Wireless Network](#)

Store Print Log to Network

- [Store Log to Network Overview](#)
- [Configure the Store Print Log to Network Settings Using Web Based Management](#)
- [Use the Store Print Log to Network's Error Detection Setting](#)

Store Log to Network Overview

The Store Print Log to Network feature allows you to save the print log file from your Brother machine to a network server using the Common Internet File System (CIFS) protocol. You can record the ID, type of print job, job name, user name, date, time and the number of printed pages for every print job. CIFS is a protocol that runs over TCP/IP, allowing computers on a network to share files over an intranet or the Internet.

The following print functions are recorded in the print log:

- Print jobs from your computer
- USB Direct Print
- Web Connect Print (supported models only)



- The Store Print Log to Network feature supports Kerberos authentication and NTLMv2 authentication. You must configure the SNTP protocol (network time server) for Authentication.
- You can set the file type to TXT or CSV when storing a file to the server.





Related Information

- [Store Print Log to Network](#)

Configure the Store Print Log to Network Settings Using Web Based Management

1. Start your web browser.
2. Type "http://machine's IP address" in your browser's address bar (where "machine's IP address" is the machine's IP address).
For example:
http://192.168.1.2
3. No password is required by default. Type a password if you have set one, and then click .
4. Click the **Administrator** tab.
5. Click the **Store Print Log to Network** menu.
6. In the **Print Log** field, click **On**.
7. Configure the following settings:

Option	Description
Network Folder Path	Type the destination folder where your log will be stored on the CIFS server (i.e., \\ComputerName\SharedFolder).
File Name	Type the file name you want to use for the print log (up to 32 characters).
File Type	Select the TXT or CSV option for the Print Log file type.
Auth. Method	Select the authentication method required for access to the CIFS server: Auto , Kerberos , or NTLMv2 . Kerberos is an authentication protocol which allows devices or individuals to securely prove their identity to network servers using a single sign-on. NTLMv2 is the authentication method used by Windows® to log into servers. <ul style="list-style-type: none">• Auto: If you select Auto, NTLMv2 will be used to the authentication method.• Kerberos: Select the Kerberos option to use Kerberos authentication only.• NTLMv2: Select the NTLMv2 option to use NTLMv2 authentication only.  <ul style="list-style-type: none">• For the Kerberos and NTLMv2 authentication, you must also configure the SNTP protocol (network time server) and DNS server.
Username	Type the user name for the authentication (up to 96 characters).  If the user name is part of a domain, enter the user name in one of the following styles: user@domain or domain\user.
Password	Type the password for the authentication (up to 32 characters).
Kerberos Server Address (if needed)	Type the KDC host address (for example: kerberos.example.com; up to 64 characters) or the IP address (for example: 192.168.56.189).
Error Detection Setting	Choose what action should be taken when the Print Log cannot be stored to the server due to a network error.

8. In the **Connection Status** field, confirm the last log status.



You can also confirm the error status on the LCD of your machine.

9. Click **Submit** to display the **Test Print Log to Network** page.

To test your settings, click **Yes** and then go to the next step.

To skip the test, click **No**. Your settings will be submitted automatically.

10. The machine will test your settings.

11. If your settings are accepted, **Test OK** appears on the screen.

If **Test Error** appears, check all settings, and then click **Submit** to display the Test page again.



Related Information

- [Store Print Log to Network](#)

Use the Store Print Log to Network's Error Detection Setting

Use Error Detection Settings to determine the action that is taken when the print log cannot be stored to the server due to a network error.

1. Start your web browser.
2. Type "http://machine's IP address" in your browser's address bar (where "machine's IP address" is the machine's IP address).

For example:

http://192.168.1.2

3. No password is required by default. Type a password if you have set one, and then click .
4. Click the **Administrator** tab.
5. Click the **Store Print Log to Network** menu in the left navigation bar.
6. In the **Error Detection Setting** section, select the **Cancel Print** or **Ignore Log & Print** option.

Option	Description
Cancel Print	If you select the Cancel Print option, the print jobs are canceled when the print log cannot be stored to the server.
Ignore Log & Print	If you select the Ignore Log & Print option, the machine prints the documentation even if the print log cannot be stored to the server.

When the store print log function has recovered, the print log is recorded as follows:

```
Id, Type, Job Name, User Name, Date, Time, Print Pages, Color Pages
1, Print(xxxxxxx), "Document01.doc", "user01", 03/03/20xx, 14:01:32, 52, 21
2, Print(xxxxxxx), "Document02.doc", "user01", 03/03/20xx, 14:45:30, ?, ?
3, <Error>, ?, ?, ?, ?, ?, ?
4, Print(xxxxxxx), "Report01.xls", "user02", 03/03/20xx, 19:30:40, 4, 4
```

- a. If the log cannot be stored at the end of printing, the print log except the number of printed pages will be recorded.
- b. If the print log cannot be stored at the beginning and the end of printing, the print log of the job will not be recorded. When the function has recovered, the error is reflected in the log.

7. Click **Submit** to display the **Test Print Log to Network** page.
To test your settings, click **Yes** and then go to the next step.
To skip the test, click **No**. Your settings will be submitted automatically.
8. The machine will test your settings.
9. If your settings are accepted, **Test OK** appears on the screen.
If **Test Error** appears, check all settings, and then click **Submit** to display the Test page again.

✓ Related Information

- [Store Print Log to Network](#)

Mobile/Web Connect

- [Brother Web Connect](#)
- [Google Cloud Print](#)
- [AirPrint](#)
- [Mobile Printing for Windows®](#)
- [Mopria® Print Service](#)
- [Brother iPrint&Scan](#)
- [Near-Field Communication \(NFC\)](#)

Brother Web Connect

- [Brother Web Connect Overview](#)
- [Online Services Used with Brother Web Connect](#)
- [Conditions for Using Brother Web Connect](#)
- [Set Up Brother Web Connect](#)
- [Download and Print Documents Using Brother Web Connect](#)

Brother Web Connect Overview

Certain websites provide services that allow users to upload and view images and files on the websites. Your Brother machine can download and print images that are already uploaded to these services.



1. Printing
2. Photos, images, documents and other files
3. Web Service

To use Brother Web Connect, your Brother machine must be connected to a network that has access to the Internet, through either a wired or wireless connection.

For network setups that use a proxy server, the machine must also be configured to use a proxy server. If you are unsure of your network configuration, check with your network administrator.



A proxy server is a computer that serves as an intermediary between computers without a direct Internet connection, and the Internet.

✓ Related Information

- [Brother Web Connect](#)

Online Services Used with Brother Web Connect

Use Brother Web Connect to access services from your Brother machine:

To use Brother Web Connect, you must have an account with the online service you want to use. If you do not already have an account, use a computer to access the service's website and create an account.

If you already have an account, there is no need to create an additional account.

Google Drive™

An online document storage, editing, sharing and file synchronization service.

URL: drive.google.com

Evernote®

An online file storage and management service.

URL: www.evernote.com

Dropbox

An online file storage, sharing and synchronization service.

URL: www.dropbox.com

OneDrive®

An online file storage, sharing and managing service.

URL: onedrive.live.com

Box

An online document editing and sharing service.

URL: www.box.com

OneNote®

An online document editing and sharing service.

URL: www.onenote.com

For more information about any of these services, refer to the respective service's website.

The following table describes which file types can be used with each Brother Web Connect feature:

Accessible Services	Google Drive™ Evernote® Dropbox OneDrive® Box OneNote®
Download and print images	JPEG PDF DOCX XLSX PPTX ¹

¹ DOC/XLS/PPT formats are also available for downloading and printing images.



(For Hong Kong, Taiwan and Korea)

Brother Web Connect supports only file names written in English. Files named in the local language will not be downloaded.



Related Information

- [Brother Web Connect](#)
-

Conditions for Using Brother Web Connect

- [Brother Software Installation for Using Brother Web Connect](#)
- [Configure the Proxy Server Settings Using Your Brother Machine's Control Panel](#)
- [Configure the Proxy Server Settings Using Web Based Management](#)

Brother Software Installation for Using Brother Web Connect

The initial installation of Brother Web Connect requires a computer that has access to the Internet and has the Brother machine's software installed.

For Windows®:

To install the Brother Software and configure the machine to be able to print over your wired or wireless network, see the *Quick Setup Guide* included with your Brother machine.

For Macintosh:

To install the Brother Software, go to your model's **Downloads** page on the Brother Solutions Center at support.brother.com.





Related Information

- [Conditions for Using Brother Web Connect](#)

Configure the Proxy Server Settings Using Your Brother Machine's Control Panel

If your network uses a proxy server, the following proxy server information must be configured on the machine:

- Proxy server address
- Port number
- User Name
- Password

1. Press  [Settings] > [All Settings] > [Network] > [Web Connect Settings] > [Proxy Settings] > [Proxy Connection] > [On].
2. Press the proxy server information, and then enter the option that you want to set.
3. Press .



Related Information

- [Conditions for Using Brother Web Connect](#)

Configure the Proxy Server Settings Using Web Based Management

If your network uses a proxy server, the following proxy server information must be configured using Web Based Management:

- Proxy server address
- Port number
- User Name
- Password



We recommend Microsoft® Internet Explorer® 11 for Windows® and Safari 9 for Macintosh. Make sure that JavaScript and Cookies are always enabled in whichever browser you use.

1. Start your web browser.
2. Type "http://machine's IP address" in your browser's address bar (where "machine's IP address" is the machine's IP address).
For example:
http://192.168.1.2
3. No password is required by default. Type a password if you have set one, and then click .
4. Click the **Network** tab.
5. Click the **Protocol** menu in the left navigation bar.
6. Make sure the **Proxy** check box is selected, and then click **Submit**.
7. In the **Proxy** field, click **Advanced Settings**.
8. Enter the proxy server information.
9. Click **Submit**.



Related Information

- [Conditions for Using Brother Web Connect](#)

Set Up Brother Web Connect

- [Brother Web Connect Setup Overview](#)
- [Create an Account for Each Online Service Before Using Brother Web Connect](#)
- [Apply for Brother Web Connect Access](#)
- [Register an Account on Your Brother Machine for Brother Web Connect](#)

Brother Web Connect Setup Overview

Configure the Brother Web Connect settings using the following procedure:

Step 1: Create an account with the service you want to use.

Access the service's website using a computer and create an account. (If you already have an account, there is no need to create an additional account.)

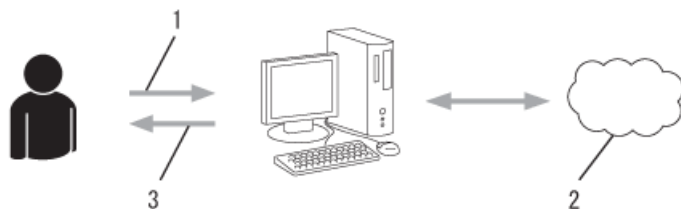

1. User registration
2. Web Service
3. Obtain account

Step 2: Apply for Brother Web Connect access.

Start Brother Web Connect access using a computer and obtain a temporary ID.

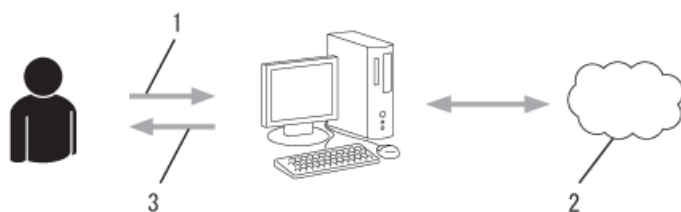

1. Enter account information
2. Brother Web Connect application page
3. Obtain temporary ID

Step 3: Register your account information on your machine so you can access the service you want to use.

Enter the temporary ID to enable the service on your machine. Specify the account name as you would like it to be displayed on the machine, and enter a PIN if you would like to use one.

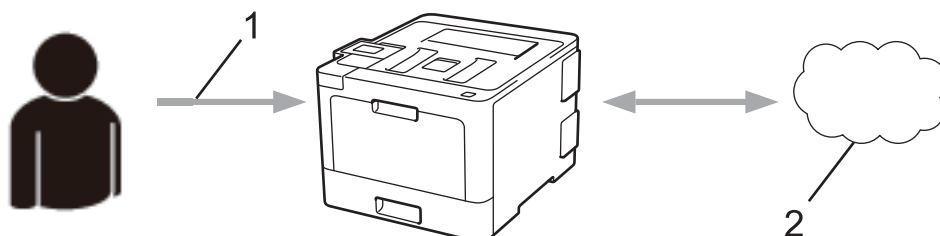

1. Enter temporary ID
2. Web Service

Your Brother machine can now use the service.



Related Information

- [Set Up Brother Web Connect](#)

Create an Account for Each Online Service Before Using Brother Web Connect

To use Brother Web Connect to access an online service, you must have an account with that online service. If you do not already have an account, use a computer to access the service's website and create an account. After creating an account, log on and use the account once with a computer before using the Brother Web Connect feature. Otherwise, you may not be able to access the service using Brother Web Connect.

If you already have an account, there is no need to create an additional account.

After you finish creating an account with the online service you want to use, apply for Brother Web Connect access.



You do not need to create an account if you use the service as a guest. You can use only certain services as a guest. If the service you want to use does not have a guest-user option, you must create an account.







Related Information

- [Set Up Brother Web Connect](#)

Apply for Brother Web Connect Access

To use Brother Web Connect to access online services, you must first apply for Brother Web Connect access using a computer that has the Brother Software installed.

1. Access the Brother Web Connect application website:

Option	Description
Windows® 7	Click  (Start) > All Programs > Brother > Brother Utilities , and then click the drop-down list and select your model name (if not already selected). Click Do More in the left navigation bar, and then click Brother Web Connect .
Windows® 8 Windows® 10	Launch  (Brother Utilities), and then click the drop-down list and select your model name (if not already selected). Click Do More in the left navigation bar, and then click Brother Web Connect .
Windows® 8.1	Move your mouse to the lower left corner of the Start screen and click  (if you are using a touch-based device, swipe up from the bottom of the Start screen to bring up the Apps screen). Click  (Brother Utilities), and then click the drop-down list and select your model name (if not already selected). Click Do More in the left navigation bar, and then click Brother Web Connect .
Macintosh	Click Go in the Finder bar, Applications > Brother > Utilities > Brother Web Connect .



You can also access the website directly:

Type bwc.brother.com into your web browser's address bar.

The Brother Web Connect page launches.



The first time you launch Brother Web Connect, you must select your country, language, and model name, and then click Next to move to the next step, selecting the service you want.

2. Select the service you want to use.

Get connected with Brother Web Connect

Click on one of the following services to be used on your machine to obtain a temporary ID. Business versions of the web services are also supported including: OneDrive for business, Dropbox for business, Google apps for work, Evernote business and Box for business.

 OneNote	 OneDrive	 Box
 Connect to Google Drive™	 EVERNOTE	 Dropbox

The services available for your machine may vary depending on the model and firmware version of your machine. If any of the web services on this page are missing from your machine or you experience any other problem with Brother Web Connect please make sure you have the latest firmware installed.

[For more information, please go to our support site.](#)

[Online User's Guide Download Page](#)



[Terms of Use](#)

The actual screen may differ from the screen shown above.

3. Follow the on-screen instructions and apply for access.

When finished, your temporary ID will appear.

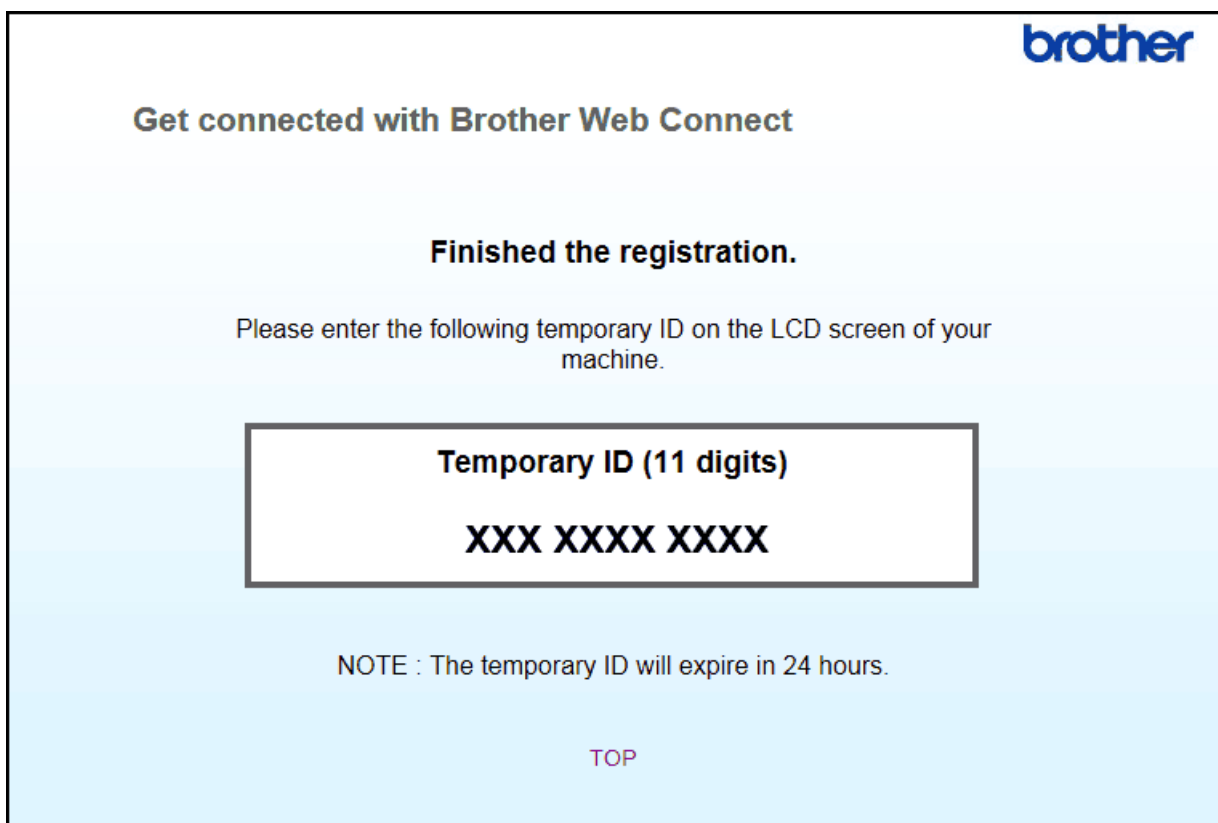

brother

Get connected with Brother Web Connect

Finished the registration.

Please enter the following temporary ID on the LCD screen of your machine.

Temporary ID (11 digits)

XXX XXXX XXXX

NOTE : The temporary ID will expire in 24 hours.

[TOP](#)

-
4. Make a note of your temporary ID, as you will need it to register accounts to the machine. The temporary ID is valid for 24 hours.
 5. Close the web browser.

Now that you have a Brother Web Connect access ID, you must register this ID on your machine, and then use your machine to access the web service you want to use.



Related Information

- [Set Up Brother Web Connect](#)
 - [Register an Account on Your Brother Machine for Brother Web Connect](#)
-

Register an Account on Your Brother Machine for Brother Web Connect

You must enter your Brother Web Connect account information and configure your machine so that it can use Brother Web Connect to access the service you want.

- You must apply for Brother Web Connect access to register an account on your machine.
- Before you register an account, confirm that the correct date and time are set on the machine.

1. Press [Functions] > [Web].



- If information regarding the Internet connection appears on the machine's LCD, read the information and press [OK]. If you want to display this information again, press [Yes].
- Occasionally, updates or announcements about Brother Web Connect's features will appear on the LCD. Read the information, and then press [OK].

2. If the information regarding license agreement appears, make your selection and follow the on-screen instructions.

3. Press ▲ or ▼ to display the service with which you want to register.

4. Press the service name.

5. If information regarding Brother Web Connect appears, press [OK].

6. Press [Register/Delete].

7. Press [Register Account].

The machine will prompt you to enter the temporary ID you received when you applied for Brother Web Connect access.

8. Press [OK].

9. Enter the temporary ID using the LCD.

10. Press [OK].

The machine will prompt you to enter the account name that you want to be displayed on the LCD.

11. Press [OK].

12. Enter the name using the LCD.

13. Press [OK].

14. Do one of the following:

- To set a PIN for the account, press [Yes]. (A PIN prevents unauthorized access to the account.) Enter a four-digit number, and then press [OK].
- If you do not want to set a PIN, press [No].

15. When the account information you entered appears, confirm that it is correct.

16. Press [Yes] to register your information as entered.



An error message will appear on the LCD if the information you entered does not match the temporary ID you received when you applied for access, or if the temporary ID has expired. Enter the temporary ID correctly, or apply for access again to receive a new temporary ID.

17. Press [OK].

18. Press .

Registration is complete and your machine can now access the service.



Related Information

- [Set Up Brother Web Connect](#)
- [Apply for Brother Web Connect Access](#)

Download and Print Documents Using Brother Web Connect

Documents that have been uploaded to your account can be downloaded directly to your machine and printed. Documents that other users have uploaded to their own accounts for sharing can also be downloaded to your machine and printed, as long as you have viewing privileges for those documents. Certain services allow guest users to view documents that are public. When accessing a service or an account as a guest user, you can view documents that the owner has made public, that is, documents with no viewing restrictions.

To download other users' documents, you must have access privileges to view the corresponding albums or documents.

If you are a restricted user for Web Connect due to the Secure Function Lock feature (available for certain models), you cannot download the data.

The Secure Function Lock Page Limit feature applies to the print job using Web Connect.



For Hong Kong, Taiwan and Korea

Brother Web Connect supports only file names written in English. Files named in the local language will not be downloaded.



Related Information

- [Brother Web Connect](#)
 - [Download and Print Using Web Services](#)
-

Download and Print Using Web Services

1. Press [Functions] > [Web].



- If information regarding the Internet connection appears on the machine's LCD, read the information and press [OK]. If you want to display this information again, press [Yes].
- Occasionally, updates or announcements about Brother Web Connect's features will appear on the LCD. Read the information, and then press [OK].

2. Press ▲ or ▼ to display the service that hosts the document you want to download and print. Press the service name.
3. To log on to the service, press ▲ or ▼ to display your account name, and then press it. If the PIN entry screen appears, enter the four-digit PIN and press [OK].
4. Press ▲ or ▼ to display the folder you want, and then press it. Some services do not require documents to be saved in folders. For documents not saved in folders, select [See Unsorted Files] to select documents. Other users' documents cannot be downloaded if they are not saved in a folder.
5. Press the thumbnail of the document you want to print. Confirm the document on the LCD and then press [OK]. Select additional documents to print (you can select up to 10 documents).
6. When finished, press [OK].
7. Follow the on-screen instructions to complete this operation.



Related Information

- [Download and Print Documents Using Brother Web Connect](#)

Google Cloud Print

- [Google Cloud Print Overview](#)
- [Before Using Google Cloud Print](#)
- [Print from Google Chrome™ or Chrome OS™](#)
- [Print from Google Drive™ for Mobile](#)
- [Print from Gmail™ Webmail Service for Mobile](#)

Google Cloud Print Overview

Google Cloud Print™ is a Google service that allows you to print to a printer registered to your Google account using a network-compatible device (such as a mobile phone or computer) without installing the printer driver on the device.

Printing from Android™ applications requires installing the Google Cloud Print™ application from the Google Play™ Store app.

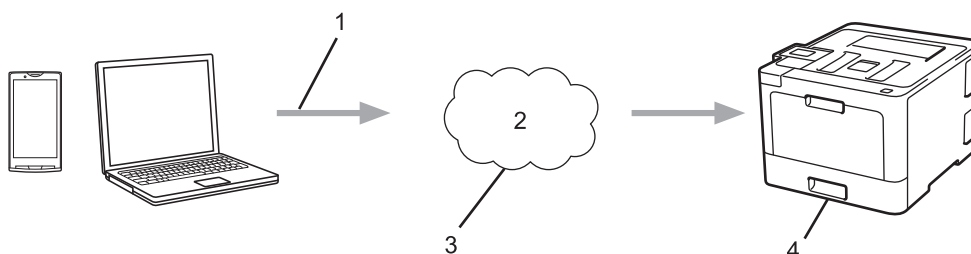

1. Print request
2. Internet
3. Google Cloud Print™
4. Printing

✓ Related Information

- [Google Cloud Print](#)

Before Using Google Cloud Print

- [Network Settings for Using Google Cloud Print](#)
- [Register Your Machine with Google Cloud Print Using Google Chrome™](#)
- [Register Your Machine with Google Cloud Print Using Web Based Management](#)

Network Settings for Using Google Cloud Print

In order to use Google Cloud Print™, your Brother machine must be connected to a network that has access to the Internet, either through a wired or wireless connection. To connect and configure your machine correctly, see the *Quick Setup Guide* or related topics in this guide.



Related Information

- [Before Using Google Cloud Print](#)
 - [Google Cloud Print Problems](#)
-

Register Your Machine with Google Cloud Print Using Google Chrome™

Make sure you have already created a Google Account. If you do not have an account, use a computer or mobile device to access the Google website (<https://accounts.google.com/signup>) and create an account. Make sure your Brother machine is idle before starting the registration process.



The steps in this section are examples for Windows users.

Screens on your computer may vary depending on your operating system and environment.

1. Open Google Chrome™ on your computer.
2. Sign in to your Google Account.
3. Click the Google Chrome™ menu icon, and then **Settings > Show advanced settings....**
4. In the **Google Cloud Print** section, click **Manage**.
5. Follow the on-screen instructions to register your machine.
6. When a confirmation message appears on your machine, press the OK button.



If the confirmation message does not appear on your machine's LCD, repeat these steps.

7. When your Brother machine is successfully registered, it will appear in the **My devices** field.



Related Information

- [Before Using Google Cloud Print](#)

Register Your Machine with Google Cloud Print Using Web Based Management

Make sure you have already created a Google Account. If you do not have an account, use a computer or mobile device to access the Google website (<https://accounts.google.com/signup>) and create an account.

Make sure your Brother machine is idle before starting the registration process.

Before you begin to register your machine, confirm that the correct date and time are set on the machine.

1. Confirm that your Brother machine is connected to the same network as your computer or mobile device.
2. Start your web browser.
3. Type "http://machine's IP address" in your browser's address bar (where "machine's IP address" is the machine's IP address).
For example:
http://192.168.1.2
4. No password is required by default. Type a password if you have set one, and then click .
5. Click the **Network** tab.
6. Click the **Protocol** menu in the left navigation bar.
7. Make sure that **Google Cloud Print** is selected, and then click **Advanced Settings**.
8. Make sure that **Status** is set to **Enabled**. Click **Register**.
9. Follow the on-screen instructions to register your machine.
10. When a confirmation message appears on your machine, press the OK button.



If the confirmation message does not appear on your machine's LCD, repeat these steps.

11. Click **Google**.
12. The sign-in screen for Google Cloud Print™ appears. Sign in with your Google Account and follow the on-screen instructions to register your machine.
13. When you have finished registering your machine, return to the Web Based Management screen and make sure that **Registration Status** is set to **Registered**.



If your machine supports the Secure Function Lock feature, printing via Google Cloud Print™ is possible even if PC print for each user is restricted. To restrict printing via Google Cloud Print™, disable Google Cloud Print™ using Web Based Management or set the Secure Function Lock feature to Public Mode, and then restrict print for public users. See *Related Information*.



Related Information

- [Before Using Google Cloud Print](#)
- [Configure Public Mode for Secure Function Lock 3.0](#)

Print from Google Chrome™ or Chrome OS™

1. Make sure your Brother machine is turned on.
2. Open the web page that you want to print.
3. Click the Google Chrome™ menu icon.
4. Click **Print**.
5. Select your machine from the printer list.
6. Change print options, if needed.
7. Click **Print**.



Related Information

- [Google Cloud Print](#)
-

Print from Google Drive™ for Mobile

1. Make sure your Brother machine is turned on.
2. Access Google Drive™ from your Android™ or Apple device's web browser.
3. Open the document that you want to print.
4. Tap the menu icon.
5. Tap **Print**.
6. Select your machine from the printer list.
7. Change print options, if needed.
8. Tap  or **Print**.



Related Information

- [Google Cloud Print](#)

Print from Gmail™ Webmail Service for Mobile

1. Make sure your Brother machine is turned on.
2. Access the Gmail™ webmail service from your Android™ or Apple device's web browser.
3. Open the email that you want to print.
4. Tap the menu icon.



If **Print** appears beside the attachment name, you can also print the attachment. Tap **Print**, and then follow the instructions on your mobile device.

5. Tap **Print**.
6. Select your machine from the printer list.
7. Change print options, if needed.
8. Tap  or **Print**.



Related Information

- [Google Cloud Print](#)

AirPrint

- [AirPrint Overview](#)
- [Before Using AirPrint](#)
- [Print Using AirPrint](#)

AirPrint Overview

Use Brother AirPrint to wirelessly print photos, emails, web pages, and documents from your iPad, iPhone and iPod touch without installing a printer driver on the device.

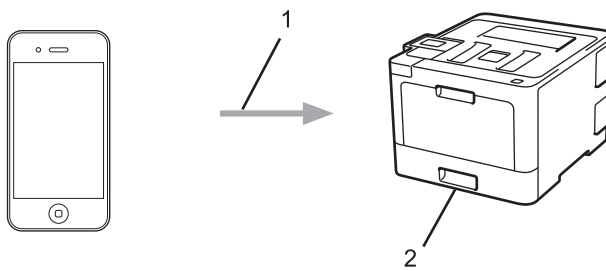

1. Print request
2. Printed photos, emails, web pages, and documents

✓ Related Information

- [AirPrint](#)
- [AirPrint Problems](#)

Before Using AirPrint

- [Network Settings for Using AirPrint](#)
- [Disable and Enable AirPrint Using Web Based Management \(Web Browser\)](#)

Network Settings for Using AirPrint

In order to use AirPrint, your mobile device must connect to the wireless network to which your Brother machine is connected. AirPrint supports wireless connections that use infrastructure mode or Wi-Fi Direct®.

To configure your mobile device for a wireless network, refer to your mobile device's user's guide. A link to your mobile device's user's guide on Apple's website can be found by tapping  in Safari.

To configure your Brother machine for a wireless network, see the *Quick Setup Guide* or related topics in this guide. If your Brother machine supports a wired network, you can use a network cable to connect to the wireless access point/router.

If your Brother machine supports Wi-Fi Direct® and you want to configure your Brother machine for a Wi-Fi Direct® network, see related topics in this Online Guide.



Related Information

- [Before Using AirPrint](#)
- [AirPrint Problems](#)

Disable and Enable AirPrint Using Web Based Management (Web Browser)

Confirm that your Brother machine is connected to the same network as your computer.

1. Start your web browser.
2. Type "http://machine's IP address" in your browser's address bar (where "machine's IP address" is the machine's IP address).

For example:

http://192.168.1.2

3. No password is required by default. Type a password if you have set one, and then click .
4. Click the **Network** tab.
5. Click the **Protocol** menu in the left navigation bar.
6. To disable AirPrint, clear the **AirPrint** check box. To enable AirPrint, select the **AirPrint** check box.



By default, AirPrint is enabled.

7. Click **Submit**.
8. Restart your machine to activate the configuration.



Related Information



- [Before Using AirPrint](#)

Print Using AirPrint

- [Print from iPad, iPhone, or iPod Touch](#)
- [Before Printing Using AirPrint \(macOS\)](#)
- [Print Using AirPrint \(macOS\)](#)

Print from iPad, iPhone, or iPod Touch

The procedure used to print may vary by application. Safari is used in the example below.

1. Make sure your Brother machine is turned on.
2. Use Safari to open the page that you want to print.
3. Tap  or .
4. Tap **Print**.
5. Make sure your Brother machine is selected.
6. If a different machine (or no printer) is selected, tap **Printer**.
A list of available machines appears.
7. Tap your machine's name in the list.
8. Select the desired options, such as the number of pages to print and 2-sided printing (if supported by your machine).
9. Tap **Print**.



Related Information

- [Print Using AirPrint](#)

Before Printing Using AirPrint (macOS)

Before printing using macOS, add your Brother machine to the printer list on your Macintosh computer.

1. Select **System Preferences** from the Apple Menu.
2. Click **Print & Scan** or **Printers & Scanners**.
3. Click the + icon below the Printers pane on the left.
4. Click **Add Printer or Scanner....** The **Add** screen appears.
5. Select your Brother machine, and then select **AirPrint** from the **Use** pop-up menu.
6. Click **Add**.



Related Information

- [Print Using AirPrint](#)

Print Using AirPrint (macOS)

The procedure used to print may vary by application. Safari is used in the example below. Before printing, make sure your Brother machine is in the printer list on your Macintosh computer.

1. Make sure your Brother machine is turned on.
2. On your Macintosh computer, use Safari to open the page that you want to print.
3. Click the **File** menu, and then select **Print**.
4. Make sure your Brother machine is selected. If a different machine (or no printer) is selected, click the **Printer** pop-up menu, and then select your Brother machine.
5. Select the desired options, such as the number of pages to print and 2-sided printing (if supported by your machine).
6. Click **Print**.



Related Information

- [Print Using AirPrint](#)

Mobile Printing for Windows®

Mobile printing for Windows® is a function to print wirelessly from your Windows® mobile device. You can connect to the same network that your Brother machine is connected to and print without installing the printer driver on the device. Many Windows® apps support this function.

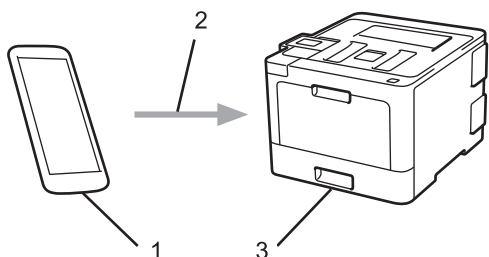

1. Windows® mobile device (Windows® 10 Mobile or later)
2. Wi-Fi® connection
3. Your Brother machine



Related Information

- [Mobile/Web Connect](#)

Mopria® Print Service

Mopria® Print Service is a print feature on Android™ mobile devices (Android™ version 4.4 or later) developed by the Mopria® Alliance. With this service, you can connect to the same network as your machine and print without additional setup. Many native Android™ apps support printing.

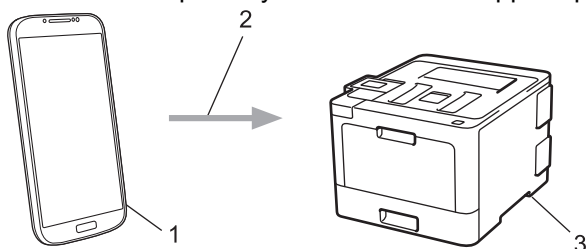

1. Android™ 4.4 or later
2. Wi-Fi® Connection
3. Your Brother machine

You must download the Mopria® Print Service from the Google Play™ Store and install it on your Android™ device. Before using this service, you must turn it on.



Related Information

- [Mobile/Web Connect](#)

Brother iPrint&Scan

Use Brother iPrint&Scan to print from various mobile devices.

- For Android™ Devices

Brother iPrint&Scan allows you to use features of your Brother machine directly from your Android™ device, without using a computer.

Download and install Brother iPrint&Scan from the Google Play™ Store app.

- For Apple Devices

Brother iPrint&Scan allows you to use features of your Brother machine directly from your Apple device.

Download and install Brother iPrint&Scan from the App Store.

- For Windows® Devices

Brother iPrint&Scan allows you to use features of your Brother machine directly from your Windows® device, without using a computer.

Download and install Brother iPrint&Scan from the Microsoft® Store.

For more information, see the *Mobile Print/Scan Guide for Brother iPrint&Scan*. Go to your model's **Manuals** page on the Brother Solutions Center at support.brother.com.



Related Information

- [Mobile/Web Connect](#)

Near-Field Communication (NFC)

Near-Field Communication (NFC) allows for simple transactions, data exchange, and wireless connections between two devices that are in close range of each other.

If your Android™ device is NFC-enabled, you can print data (photos, PDF files, text files, web pages and email messages) from the device by touching it to the NFC symbol on the machine's control panel.

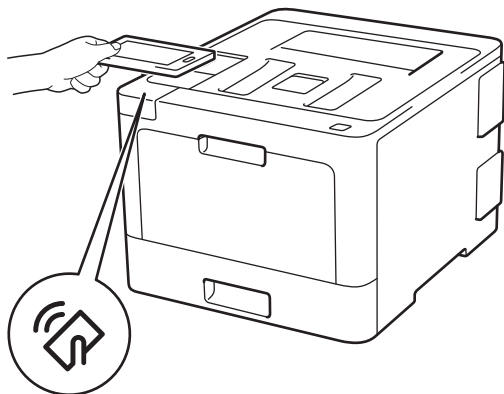

You must download and install Brother iPrint&Scan on your Android™ device to use this feature. For more information, see the *Mobile Print/Scan Guide for Brother iPrint&Scan*. Go to your model's **Manuals** page on the Brother Solutions Center at support.brother.com.

✓ Related Information

- [Mobile/Web Connect](#)
- [Register an External IC Card Reader](#)

Register an External IC Card Reader

When you connect an external IC card reader, use Web Based Management to register the card reader. Your machine supports HID class driver supported external IC card readers.

1. Start your web browser.
2. Type "http://machine's IP address" in your browser's address bar (where "machine's IP address" is the machine's IP address).

For example:

http://192.168.1.2

3. No password is required by default. Type a password if you have set one, and then click .
4. Click the **Administrator** tab.
5. Click the **External Card Reader** menu, and then enter the necessary information.
6. Click **Submit**.
7. Restart your Brother machine to activate the configuration.



Related Information

- [Near-Field Communication \(NFC\)](#)

Troubleshooting

Use this section to resolve typical problems you may encounter when using your Brother machine. You can correct most problems yourself.

IMPORTANT

For technical help, you must call the country where you bought the machine. Calls must be made from within that country.

Using non-Brother supplies may affect the print quality, hardware performance, and machine reliability.



If you need additional help, go to the Brother Solutions Center at support.brother.com.

First, check the following:

- The machine's power cord is connected correctly and the machine's power is on. See the *Quick Setup Guide*.
- All of the protective materials have been removed. See the *Quick Setup Guide*.
- Paper is loaded correctly in the paper tray.
- The interface cables are securely connected to the machine and the computer, or the wireless connection is set up on both the machine and your computer.
- Error and maintenance messages

If you did not solve the problem with the checks, identify the problem and then see *Related Information*.



Related Information

- [Error and Maintenance Messages](#)
- [Error Messages When Using the Brother Web Connect Feature](#)
- [Paper Jams](#)
- [Printing Problems](#)
- [Improve the Print Quality](#)
- [Network Problems](#)
- [Google Cloud Print Problems](#)
- [AirPrint Problems](#)
- [Other Problems](#)
- [Check the Machine Information](#)
- [Reset Functions](#)

Error and Maintenance Messages



If the LCD displays errors and your Android™ device supports the NFC feature, touch your device to the NFC symbol on your Brother machine to access the Brother Solutions Center and browse the latest FAQs from your device. (Your mobile telephone provider's message and data rates may apply.)

Make sure the NFC settings of both your Brother machine and your Android™ device are set to On.



As with any sophisticated office product, errors may occur and supply items may have to be replaced. If this happens, your machine identifies the error or required routine maintenance and shows the appropriate message. The most common error and maintenance messages are shown in the table.

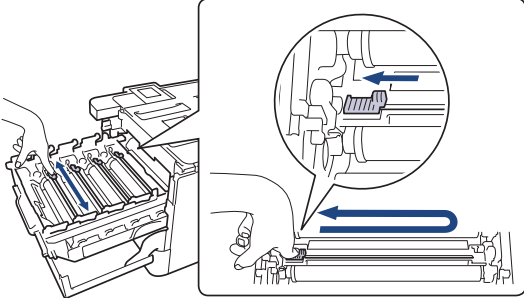

Follow the instructions in the **Action** column to solve the error and remove the message.

You can correct most errors and perform routine maintenance by yourself. If you need more tips: Visit support.brother.com, and click the **FAQs & Troubleshooting** page.

Error Message	Cause	Action
2-sided Disabled	The back cover of the machine is not closed completely.	Close the back cover of the machine until it locks in the closed position.
Access Denied	The function you want to use is restricted by Secure Function Lock 3.0.	Call your administrator to check your Secure Function Lock Settings.
Calibration	Calibration failed.	<ul style="list-style-type: none"> Press and hold down  to turn off the machine. Wait a few seconds, and then turn it on again. Perform the color calibration again using the LCD. Install a new belt unit. If the problem continues, contact Brother Customer Service or your local Brother dealer.
Cartridge Error	The toner cartridge is not installed correctly.	<p>Pull out the drum unit, remove the toner cartridge for the color that is indicated on the LCD, and place it back in the drum unit. Install the drum unit in the machine again.</p> <p>If the problem continues, contact Brother Customer Service or your local Brother dealer.</p>
Condensation	Condensation may have formed inside the machine after a room temperature change.	Leave the machine turned on. Wait for 30 minutes with the front cover in the open position. Then turn off the machine and close the cover. Turn it on again.
Cooling Down	The temperature of the inside of the machine is too hot. The machine pauses its current print job and goes into cooling down mode.	<p>Wait until the machine has finished cooling down. Make sure all vents on the machine are clear of obstructions.</p> <p>When the machine has cooled down, the machine will resume printing.</p>
Cover is Open	The front cover is not completely closed.	Open and then firmly close the front cover of the machine.
Cover is Open	The fuser cover is not completely closed.	Close the fuser cover located inside the back cover of the machine.

Error Message	Cause	Action
Drum !	The corona wires on the drum unit must be cleaned.	<p>Clean the corona wires on the drum unit.</p>  <p>See <i>Related Information: Clean the Corona Wires</i>.</p> <p>If the problem continues, replace the drum unit with a new one.</p>
	The drum unit or the toner cartridge and drum unit assembly is not installed correctly.	Remove the drum unit, remove the toner cartridges from the drum unit, and put the toner cartridges back into the drum unit. Reinstall the drum unit in the machine.
Drum Stop	It is time to replace the drum unit.	Replace the drum unit.
Jam 2-sided	The paper is jammed underneath the paper tray or the fuser unit.	Remove the paper tray or open the back cover to pull out all jammed paper.
Jam Inside	The paper is jammed inside the machine.	Open the front cover, remove the toner cartridges and drum unit assembly, and pull out all jammed paper. Close the front cover.
Jam MP Tray	The paper is jammed in the MP tray.	Remove all jammed paper from in and around the MP tray. Press <code>Retry</code> .
Jam Rear	The paper is jammed in the back of the machine.	Open the fuser cover and remove all jammed paper. Close the fuser cover. If the error message remains, press <code>Start</code> .
Jam Tray Jam Tray1 Jam Tray2 Jam Tray3 Jam Tray4	The paper is jammed in the indicated paper tray.	Pull out the paper tray and remove all jammed paper as shown in the animation on the LCD.
Limit Exceeded	The print limit set in Secure Function Lock 3.0 was reached.	Call your administrator to check your Secure Function Lock Settings.
Media Type Mismatch	The media type specified in the printer driver differs from the paper type specified in the machine's menu.	Load the correct type of paper in the tray indicated on the LCD, and then select the correct media type in the Paper Type setting on the machine.
No Belt Unit	The belt unit is not installed or not installed correctly.	Reinstall the belt unit.
No Drum Unit	The drum unit is not installed correctly.	Reinstall the toner cartridges and drum unit assembly.
No HUB Support	A USB hub device is connected to the USB host connector.	Disconnect the USB hub device from the USB host connector.
No Paper	The machine is out of paper, or paper is not loaded correctly in the paper tray.	<ul style="list-style-type: none"> • Refill paper in the paper tray. Make sure the paper guides are set to the correct size. • If paper is in the tray, remove it and load it again. Make sure the paper guides are set to the correct size. • Do not overfill the paper tray.

Error Message	Cause	Action
No Paper Fed Tray1 No Paper Fed Tray2 No Paper Fed Tray3 No Paper Fed Tray4	The machine failed to feed paper from the indicated paper tray.	Pull out the paper tray indicated on the LCD and remove all jammed paper.
No Paper MP	The MP tray is out of paper, or paper is not loaded correctly in the MP tray.	Do one of the following: <ul style="list-style-type: none"> • Refill paper in the MP tray. Make sure the paper guides are set to the correct size. • If paper is in the tray, remove it and load it again. Make sure the paper guides are set to the correct size.
No Paper Tray1 No Paper Tray2 No Paper Tray3 No Paper Tray4	The machine failed to feed paper from the indicated paper tray.	Do one of the following: <ul style="list-style-type: none"> • Refill paper in the paper tray indicated on the LCD. Make sure the paper guides are set to the correct size. • If paper is in the tray, remove it and load it again. Make sure the paper guides are set to the correct size. • Do not overfill the paper tray.
No Toner	The toner cartridge for the color indicated on the LCD is not installed or not installed correctly.	Remove the toner cartridge for the color indicated on the LCD from the drum unit, and put the toner cartridge back into the drum unit. If the problem continues, replace the toner cartridge.
No Tray1 No Tray2 No Tray3 No Tray4	The paper tray is not installed or not installed correctly.	Reinstall the paper tray indicated on the LCD.
No Waste Toner	The waste toner box is not installed or not installed correctly.	Reinstall the waste toner box.
Out of Memory	The machine's memory is full.	Press  and reduce the print resolution.
Paper Low Paper Low Tray 1 Paper Low Tray 2 Paper Low Tray 3 Paper Low Tray 4	The paper tray is nearly empty.	Refill the paper in the paper tray indicated on the LCD.
Print Data Full	The machine's memory is full.	Press  and delete the previously stored secure print data.
Print Unable ##	The machine has a mechanical problem.	<ul style="list-style-type: none"> • Press and hold  to turn off the machine, wait a few minutes, and then turn it on again. • If the problem continues, contact Brother Customer Service. Contact Brother Customer Service at: 1-877-BROTHER (1-877-276-8437) (in USA) www.brother.ca/support (in Canada) or to locate a Brother Authorized Service Center, visit: www.brother-usa.com/service

Error Message	Cause	Action
Registration	Registration failed.	<ul style="list-style-type: none"> Press and hold down  to turn off the machine. Wait a few seconds, and then turn it on again. Perform the color registration again using the LCD. Install a new belt unit. If the problem continues, contact Brother Customer Service or your local Brother dealer.
Replace Toner	The toner cartridge is at the end of its life. The machine stops all print operations.	Replace the toner cartridge for the color indicated on the LCD.
Replace WT Box	It is time to replace the waste toner box.	Replace the waste toner box with a new one.
Screen Init. Fail	The Touchscreen was pressed before the power on initialization was completed.	Make sure nothing is touching the Touchscreen.
	Debris may be stuck between the lower part of the Touchscreen and its frame.	Insert a piece of stiff paper between the lower part of the Touchscreen and its frame and slide it back and forth to push out any debris.
Self-Diagnostic	The temperature of the fuser unit does not rise to a specified temperature within the specified time.	Press and hold  to turn off the machine, wait a few seconds, and then turn it on again. Leave the machine idle for 15 minutes with the power on.
	The fuser unit is too hot.	
Short paper	The length of the paper in the tray is too short for the machine to deliver it to the Face down output tray.	Open the back cover (Face up output tray) to let the printed page exit onto the Face up output tray. Remove the printed pages, and then press <code>Retry</code> .
Size Error	The paper size defined in the printer driver is not supported by the defined tray.	Choose a paper size supported by the defined tray.
Size Error 2-sided	The paper size specified in the machine's paper size setting is not available for automatic 2-sided printing.	Press  (if required). Load the correct size of paper in the tray and set the tray for that paper size.
	The paper in the tray is not the correct size and is not available for automatic 2-sided printing.	Choose a paper size supported by 2-sided printing. Paper sizes available for automatic 2-sided printing are Letter, Legal, Mexico Legal and Folio.
Size Mismatch	The paper in the tray is not the correct size.	Load the correct size of paper in the tray indicated on the LCD and set the size of paper for the tray. Press <code>Retry</code> .
Supplies Belt End Soon	The belt unit is near the end of its life.	Order a new belt unit before the LCD displays <code>Replace Belt</code> .
Supplies Drum End Soon	The drum unit is near the end of its life.	Order a new drum unit before the LCD displays <code>Replace Drum</code> .
Supplies Replace Belt	It is time to replace the belt unit.	Replace the belt unit with a new one.

Error Message	Cause	Action
Supplies Replace Drum	It is time to replace the drum unit.	Replace the drum unit with a new one. See <i>Related Information: Replace the Drum Unit</i> .
	The drum unit counter was not reset when a new drum was installed.	Reset the drum unit counter. See the instructions included with the new drum unit.
Supplies Toner Low: X (X indicates the toner cartridge or drum unit color that is near the end of its life. BK=Black, C=Cyan, M=Magenta, Y=Yellow.)	If the LCD displays this message, you can still print. The toner cartridge is near the end of its life.	Order a new toner cartridge before the LCD displays <code>Replace Toner</code> .
Supplies WT Box End Soon	The waste toner box is almost full.	Order a new waste toner box before the LCD displays <code>Replace WT Box</code> .
Toner Error	One or more toner cartridges are not installed or not installed correctly.	Pull out the drum unit. Remove all the toner cartridges, and then put them back into the drum unit.
Too Many Trays	The number of installed Optional Trays exceeds the maximum number.	Reduce the number of Optional Trays.
Tray 2 Error Tray 3 Error Tray 4 Error	The optional lower tray is not installed correctly.	Reinstall the lower tray.
Unusable Device	An unsupported USB device has been connected to the USB host connector.	Unplug the device from the USB host connector.
Unusable Device Remove the Device. Turn the power off and back on again.	A defective USB device or a high power consumption USB device has been connected to the USB direct interface.	<ul style="list-style-type: none"> Unplug the device from the USB direct interface. Press and hold  to turn off the machine, and then turn it on again.



Related Information

- [Troubleshooting](#)
- [Replace Supplies](#)
- [Load and Print Using the Paper Tray](#)
- [Load and Print Using the Multi-purpose Tray \(MP Tray\)](#)
- [Replace the Drum Unit](#)
- [Clean the Corona Wires](#)

Error Messages When Using the Brother Web Connect Feature

Your Brother machine displays an error message if an error occurs. The most common error messages are shown in the table.

You can correct most errors yourself. If, after reading this table, you still need help, the Brother Solutions Center offers the latest troubleshooting tips.

Go to the Brother Solutions Center at support.brother.com.

Connection Error

Error Messages	Cause	Action
Connection Error 02 Network connection failed. Verify that the network connection is good.	The machine is not connected to a network.	<ul style="list-style-type: none"> Verify that the network connection is good. If the Web button was pressed soon after the machine was turned on, the network connection may not have been established yet. Wait and try again.
Connection Error 03 Connection failed to server. Check network settings.	<ul style="list-style-type: none"> Network or server settings are incorrect. There is a problem with the network or server. 	<ul style="list-style-type: none"> Confirm that network settings are correct, or wait and try again later. If the Web button was pressed soon after the machine was turned on, the network connection may not have been established yet. Wait and try again.
Connection Error 07 Connection failed to server. Wrong Date&Time.	Date and time settings are incorrect.	Set the date and time correctly. Note that if the machine's power cord is disconnected, the date and time settings may have reset to factory settings.

Authentication Error

Error Messages	Cause	Action
Authentication Error 01 Incorrect PIN code. Enter PIN correctly.	The PIN you entered to access the account is incorrect. The PIN is the four-digit number that was entered when registering the account to the machine.	Enter the correct PIN.
Authentication Error 02 Incorrect or expired ID, or this temporary ID is already used. Enter correctly or reissue temporary ID. Temporary ID is valid for 24 hours after it is issued.	The temporary ID that was entered is incorrect .	Enter the correct temporary ID.
	The temporary ID that was entered has expired. A temporary ID is valid for 24 hours.	Apply for Brother Web Connect access again and receive a new temporary ID, and then use the new ID to register the account to the machine.
Authentication Error 03 Display name has already been registered. Enter another display name.	The name you entered as the display name has already been registered to another service user.	Enter a different display name.

Server Error

Error Messages	Cause	Action
Server Error 01 Authentication failed. Do the following: 1. Go to http://bwc.brother.com to get a new temporary ID. 2. Press OK and enter your new temporary ID in the next screen.	The machine's authentication information (needed to access the service) has expired or is invalid.	Apply for Brother Web Connect access again to receive a new temporary ID, and then use the new ID to register the account to the machine.
Server Error 03 Failed to upload. Unsupported file or corrupt data. Confirm data of file.	The file you are trying to upload may have one of the following problems: <ul style="list-style-type: none">• The file exceeds the service's limit on number of pixels, file size, etc.• The file type is not supported.• The file is corrupted.	The file cannot be used: <ul style="list-style-type: none">• Check the service's size or format restrictions.• Save the file as a different type.• If possible, get a new, uncorrupted version of the file.
Server Error 13 Service temporarily unavailable. Try again later.	There is a problem with the service and it cannot be used now.	Wait and try again. If you get the message again, access the service from a computer to confirm if it is unavailable.

Shortcut Error

Error Messages	Cause	Action
ShortCut Error 02 Account is invalid. Please register account and shortcut again after deleting this shortcut.	The shortcut cannot be used because the account was deleted after the shortcut was registered.	Delete the shortcut, and then register the account and shortcut again.



Related Information

- [Troubleshooting](#)
-

Paper Jams

Always remove the remaining paper from the paper tray and straighten the stack when you are adding new paper. This helps prevent multiple sheets of paper from feeding through the machine at one time and prevents paper jams.

- [Paper is Jammed in the MP tray](#)
- [Paper is Jammed in the Paper Tray](#)
- [Paper is Jammed in the Back of the Machine](#)
- [Paper is Jammed Inside the Machine](#)
- [Paper is Jammed underneath the Paper Tray](#)

Paper is Jammed in the MP tray

If the machine's control panel or the Status Monitor indicates that there is a jam in the machine's MP tray, follow these steps:

1. Remove the paper from the MP tray.
2. Remove any jammed paper from in and around the MP tray.



3. Fan the paper stack, and then put it back in the MP tray.
4. Reload paper in the MP tray and make sure the paper stays under the maximum paper height guides (1) on both sides of the tray. Place the paper's leading edge (top of paper) between the ▲ and ▼ arrows (2).

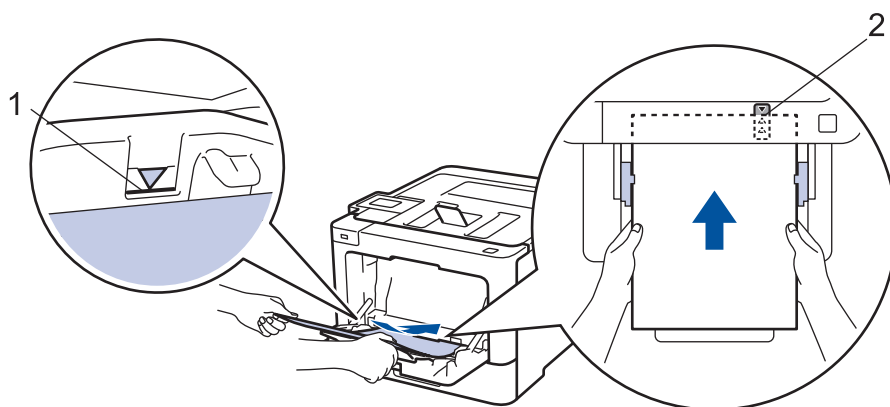

5. Follow the instructions on the machine's LCD.

✓ Related Information

- [Paper Jams](#)

Paper is Jammed in the Paper Tray

If the machine's control panel or the Status Monitor indicates that there is a jam in the paper tray, follow these steps:

1. Pull the paper tray completely out of the machine.



2. Slowly pull out the jammed paper.

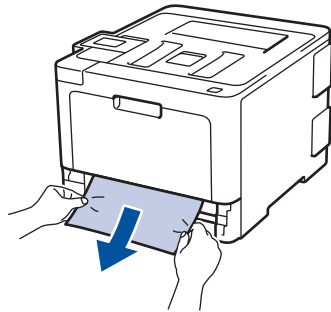

Pulling the jammed paper downward using both hands allows you to remove the paper more easily.

3. Fan the stack of paper to prevent further jams, and slide the paper guides to fit the paper size.

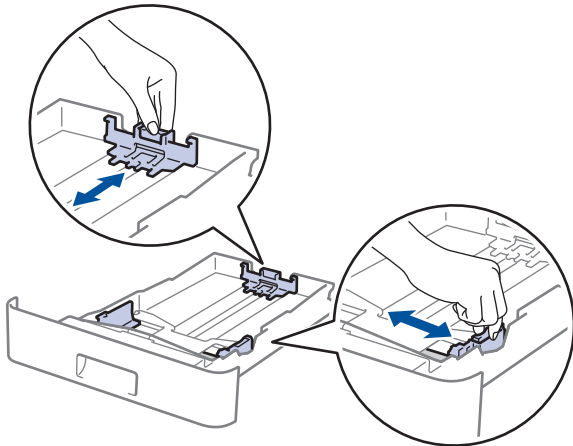

4. Make sure the paper is below the maximum paper mark (▼▼▼).

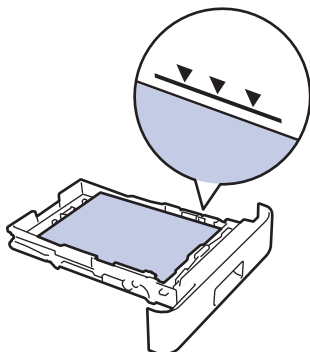

5. Put the paper tray firmly back in the machine.



Related Information

- [Paper Jams](#)
-

Paper is Jammed in the Back of the Machine

If the machine's control panel or the Status Monitor indicates that there is a jam in the back (Rear) of the machine, follow these steps:

1. Leave the machine turned on for 10 minutes for the internal fan to cool the extremely hot parts inside the machine.
2. Open the back cover.

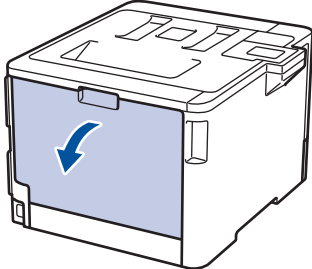

3. Pull the green levers at the left and right sides toward you to release the fuser cover.

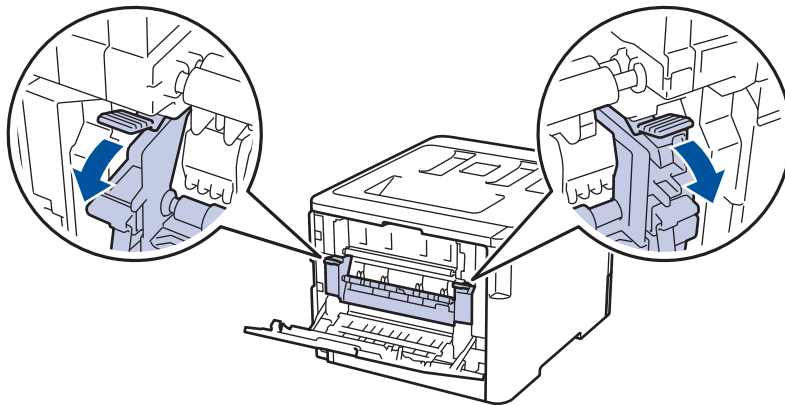

WARNING

HOT SURFACE

The machine's internal parts will be extremely hot. Wait for the machine to cool down before touching them.

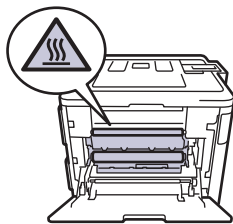

 If the gray envelope levers inside the back cover are pulled down to the envelope position, lift these levers to the original position before pulling the green tabs down.

4. Use both hands to gently pull the jammed paper out of the fuser unit.

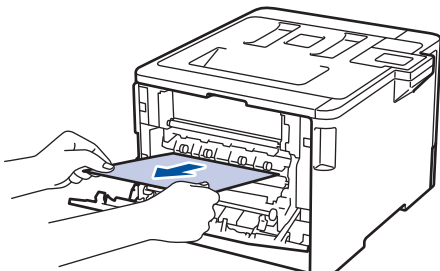

5. Close the fuser cover.

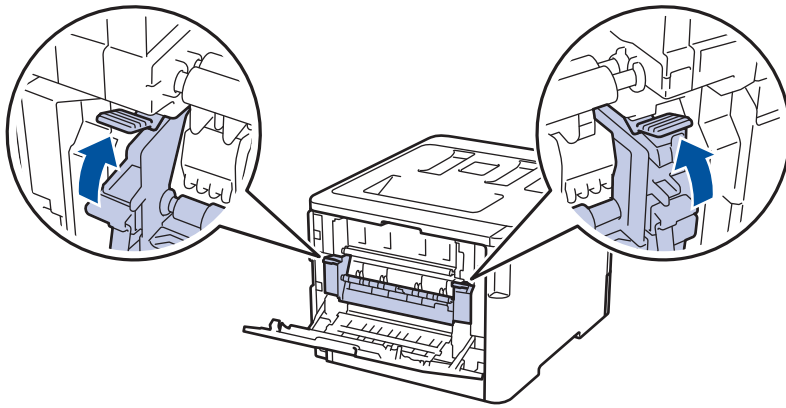

If you print on envelopes, pull down the gray envelope levers to the envelope position again before closing the back cover.

6. Close the back cover until it locks in the closed position.



Related Information

- [Paper Jams](#)
-

Paper is Jammed Inside the Machine

If the machine's control panel or the Status Monitor indicates that there is a jam inside the machine, follow these steps:

1. Press the front cover release button and pull open the front cover.

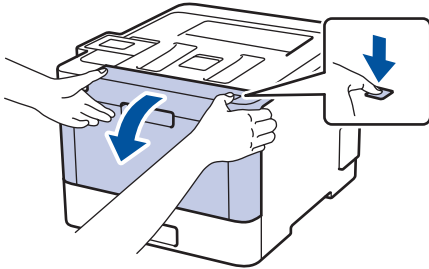

2. Hold the drum unit's green handle. Pull the drum unit out of the machine until it stops.

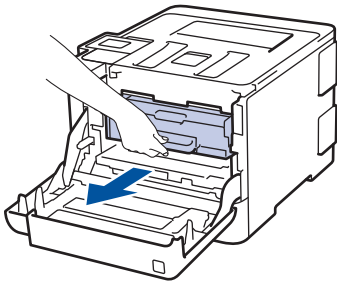

3. Turn the green lock lever (1) counterclockwise until it locks in the release position. Holding the green handles of the drum unit, lift the front of the drum unit and remove it from the machine.

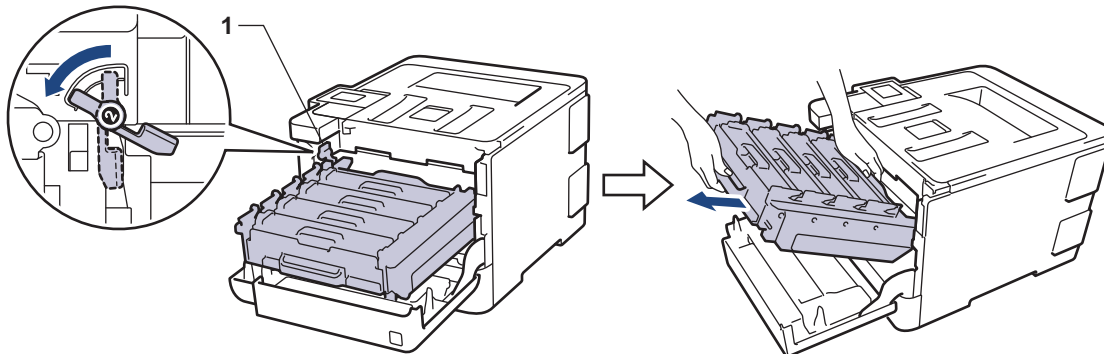

IMPORTANT

Hold the green handles of the drum unit when you carry it. DO NOT hold the sides of the drum unit.

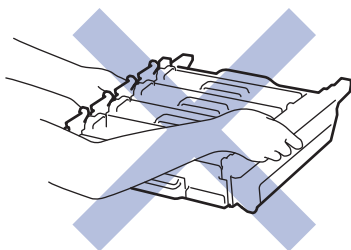

4. Pull out the jammed paper slowly.

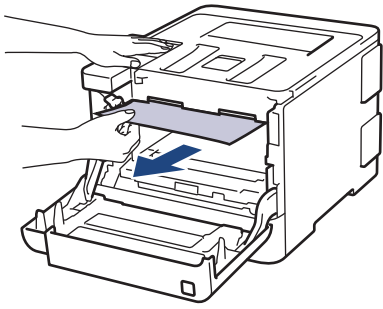

IMPORTANT

To avoid print quality problems, DO NOT touch the shaded parts shown in the illustrations.

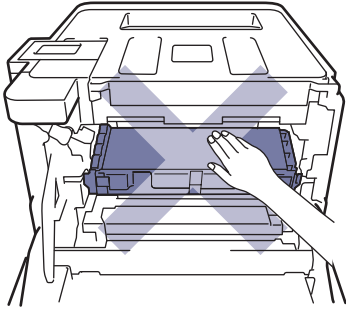

5. Make sure the green lock lever (1) is in the release position, as shown in the illustration.

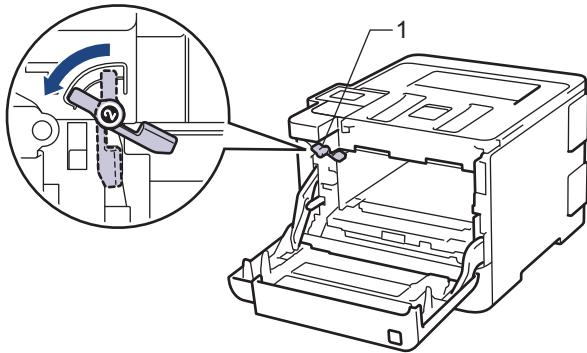

6. Gently slide the drum unit into the machine until it stops at the green lock lever.

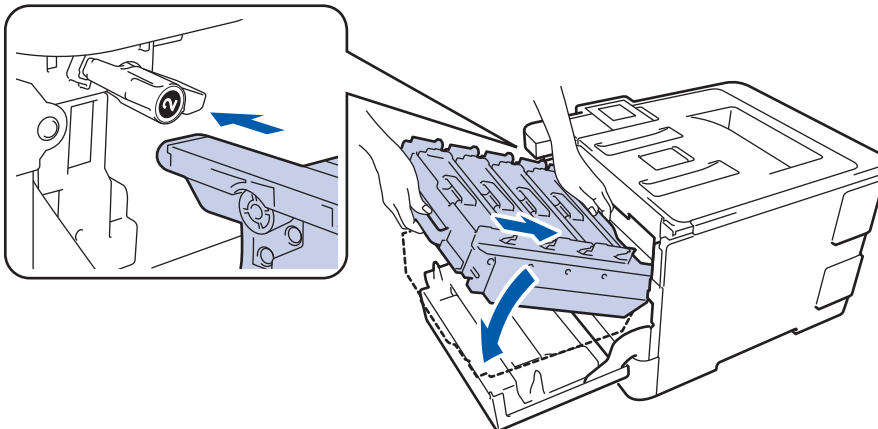

7. Turn the green lock lever clockwise to the lock position.

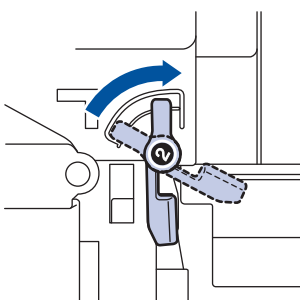

8. Using the green handle, push the drum unit back into the machine until it locks in place.

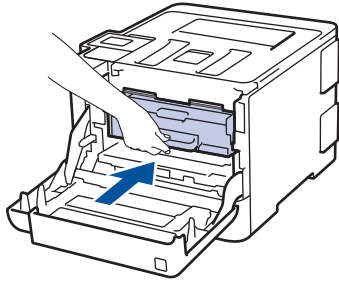

9. Close the machine's front cover.



Related Information

- [Paper Jams](#)

Paper is Jammed underneath the Paper Tray

If the machine's control panel or the Status Monitor indicates that there is a jam in the paper tray, follow these steps:

1. Leave the machine turned on for 10 minutes for the internal fan to cool the extremely hot parts inside the machine.
2. Pull the paper tray completely out of the machine.

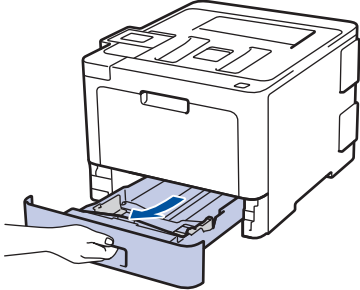

3. Make sure the jammed paper does not remain inside the machine.

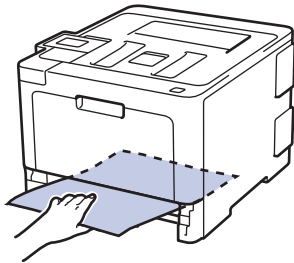

4. If paper is not jammed inside the machine, remove the paper from the paper tray, flip it over, and check underneath the paper tray.

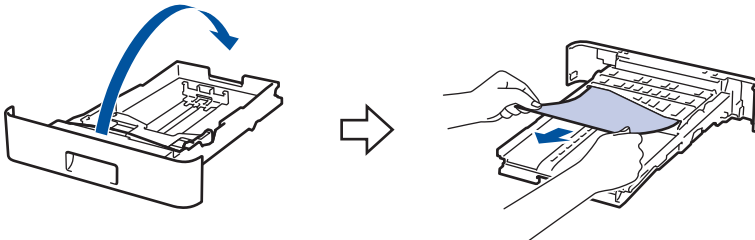

5. If the paper is not jammed in the paper tray, open the back cover.

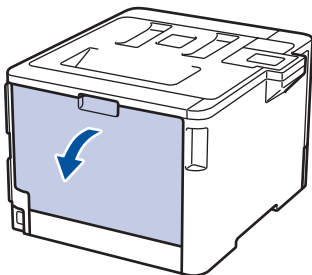

WARNING

HOT SURFACE

The machine's internal parts will be extremely hot. Wait for the machine to cool down before touching them.

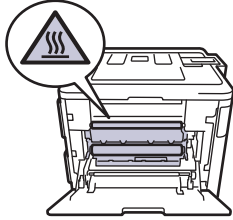

-
6. Use both hands to gently pull the jammed paper out of the back of the machine.

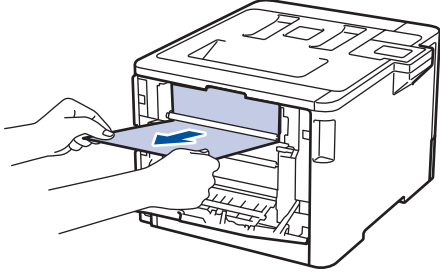







7. Close the back cover until it locks in the closed position.
8. Put the paper tray firmly back in the machine.

Related Information

- [Paper Jams](#)
-

Printing Problems

Difficulties	Suggestions
No printout	<p>Check the machine is not in Power Off mode.</p> <p>If the machine is in Power Off mode, press  on the control panel, and then send the print data again.</p> <p>Check that the correct printer driver has been installed and selected.</p> <p>Check to see if the Status Monitor or the machine's control panel displays an error status.</p> <p>Check that the machine is online:</p> <ul style="list-style-type: none"> • Windows® 7 and Windows Server® 2008 R2 <p>Click  (Start) > Devices and Printers. Right-click Brother XXX-XXXX and click See what's printing. Click Printer in the menu bar. Make sure Use Printer Offline is not selected.</p> • Windows Server® 2008 <p>Click  (Start) > Control Panel > Hardware and Sound > Printers. Right-click Brother XXX-XXXX. Make sure Use Printer Online is not listed. If it is listed, click this option to set the driver Online.</p> • Windows® 8 and Windows Server® 2012 <p>Move your mouse to the lower right corner of your desktop. When the menu bar appears, click Settings > Control Panel > Hardware and Sound > Devices and Printers. Right-click the Brother XXX-XXXX. Click See what's printing. If printer driver options appear, select your printer driver. Click Printer in the menu bar and make sure that Use Printer Offline is not selected.</p> • Windows® 10 and Windows Server® 2016 <p>Click  > Windows System > Control Panel. In the Hardware and Sound group, click View devices and printers. Right-click the Brother XXX-XXXX. Click See what's printing. If printer driver options appear, select your printer driver. Click Printer in the menu bar and make sure that Use Printer Offline is not selected.</p> • Windows Server® 2012 R2 <p>Click Control Panel on the Start screen. In the Hardware group, click View devices and printers. Right-click the Brother XXX-XXXX. Click See what's printing. If printer driver options appear, select your printer driver. Click Printer in the menu bar and make sure Use Printer Offline is not selected.</p> • Macintosh <p>Click the System Preferences menu, and then select the Printers & Scanners option. When the machine is offline, delete it using the  button, and then add it using the  button.</p>

Difficulties	Suggestions
The machine is not printing or has stopped printing.	Cancel the print job and clear it from the machine's memory. The printout may be incomplete. Send the print data again. <i>See Related Information:Cancel a Print Job.</i>
The headers or footers appear when the document displays on the screen but they do not show up when it is printed.	There is an unprintable area on the top and bottom of the page. Adjust the top and bottom margins in your document to allow for this.
The machine prints unexpectedly or it prints garbage.	Cancel the print job and clear it from the machine's memory. The printout may be incomplete. Send the print data again. <i>See Related Information:Cancel a Print Job.</i>
	Check the settings in your application to make sure they are set up to work with your machine.
	Confirm that the Brother printer driver is selected in your application's Print window.
The machine prints the first couple of pages correctly, then some pages have missing text.	Check the settings in your application to make sure they are set up to work with your machine.
	Your machine is not receiving all of the data sent from the computer. Make sure you connected the interface cable correctly.
The machine does not print on both sides of the paper even though the printer driver setting is 2-sided and the machine supports automatic 2-sided printing.	Check the paper size setting in the printer driver. You must select Letter, Legal, Folio, or Mexico Legal paper that is 16 to 28 lb (60 to 105 g/m ²).
Print speed is too slow.	Try changing the printer driver setting. The highest resolution needs longer data processing, sending and printing time.
	If you have enabled the Quiet Mode, disable the Quiet Mode on the printer driver or the machine's menu setting.
The machine does not feed paper.	If there is paper in the paper tray, make sure it is straight. If the paper is curled, straighten it. Sometimes it is helpful to remove the paper, turn the stack over and place it back in the paper tray.
	Reduce the amount of paper in the paper tray, and then try again.
	Make sure MP Tray is not selected for Paper Source in the printer driver.
	Clean the paper pick-up rollers.
The machine does not feed paper from the MP tray.	Fan the paper well and place it back in the MP tray firmly.
	Make sure MP Tray is selected as Paper Source in the printer driver.
The machine does not feed envelopes.	Load envelopes in the MP tray. Your application must be set to print the envelope size you are using. This is usually done in the Page Setup or Document Setup menu of your application.



Related Information

- [Troubleshooting](#)
- [Monitor the Status of the Machine from Your Computer \(Windows®\)](#)
- [Monitor the Status of the Machine from Your Computer \(Macintosh\)](#)
- [Cancel a Print Job](#)
- [Load and Print Using the Paper Tray](#)

-
- Clean the Paper Pick-up Rollers
 - Load and Print Using the Multi-purpose Tray (MP Tray)
-



Improve the Print Quality





If you have a print quality problem, print a test page first. If the printout looks good, the problem is probably not the machine. Check the interface cable connections and try printing a different document. If the printout or test page printed from the machine has a quality problem, check the examples of poor print quality and follow the recommendations in the table.

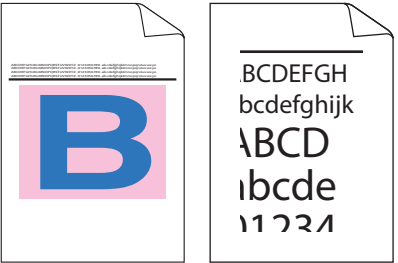

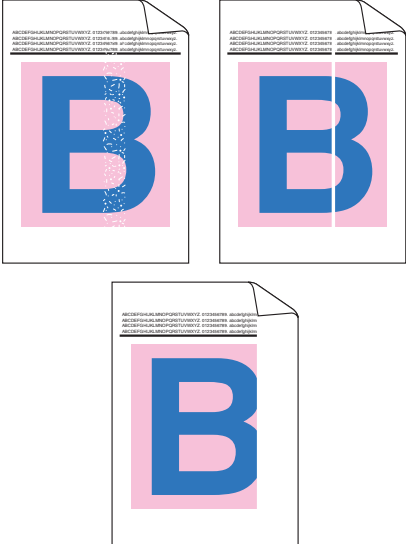
IMPORTANT

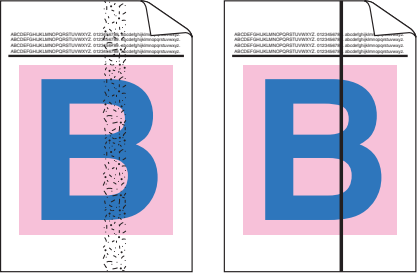

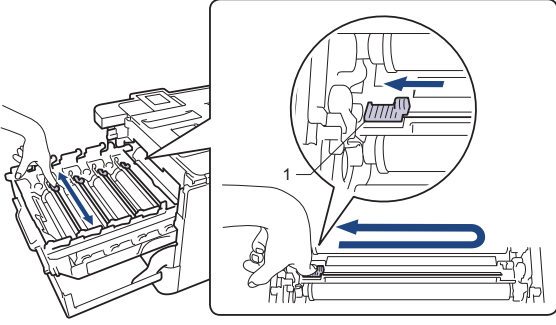
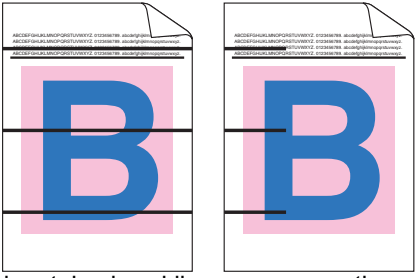
Using non-genuine supplies may affect the print quality, hardware performance, and machine reliability.

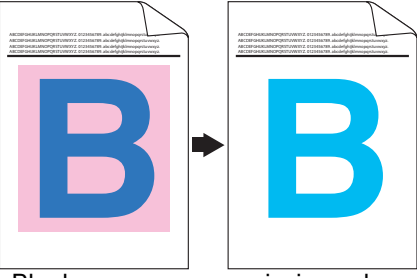

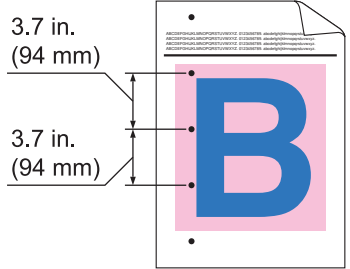
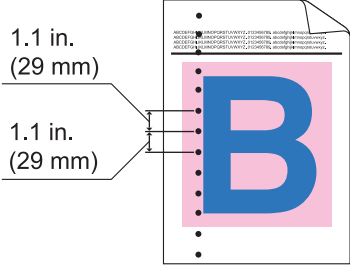
1. To get the best print quality, we suggest using recommended print media. Make sure you use paper that meets our specifications. See *Related Information:Recommended Print Media*
2. Check that the drum unit and toner cartridges are installed correctly.

Examples of poor print quality	Recommendation
 <p>Printed pages are compressed, horizontal stripes appear, or characters in the top, bottom, left, or right margins are cut off</p>	<p>Adjust the print margins in your document's application and reprint the job.</p>
 <p>Colors are light or faint on the whole page</p>	<ul style="list-style-type: none"> • Use the machine's LCD to perform calibration. See <i>Related Information:Calibrate Color Output</i>. • Make sure Toner Save mode is off in the LCD or the printer driver. <i>See Related Information:Reduce Toner Consumption</i>. • Make sure the media type setting in the printer driver matches the type of paper you are using. • Shake all four toner cartridges gently. • Wipe the laser scanner windows with a dry, soft lint-free cloth.
 <p>Vertical white streaks or bands appear on the page</p>	<ul style="list-style-type: none"> • Wipe the laser scanner windows with a dry, soft lint-free cloth. • Make sure foreign material such as a torn piece of paper, sticky notes, or dust is not inside the machine and around the drum unit and toner cartridge.

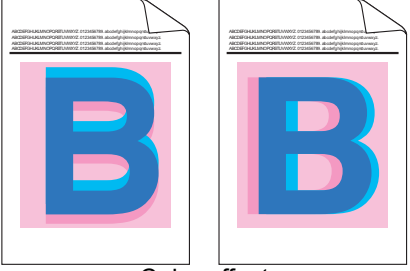
Examples of poor print quality	Recommendation
 <p data-bbox="177 483 775 517">Vertical colored streaks or bands appear on the page</p>	<ul data-bbox="820 170 1461 230" style="list-style-type: none"> • Clean all four corona wires (one for each color) inside the drum unit by sliding the green tab. <p data-bbox="852 248 1461 331">  Make sure the green tab of the corona wire is in the home position(1). </p>  <ul data-bbox="820 680 1461 981" style="list-style-type: none"> • Replace the toner cartridge that matches the color of the streak or band. To identify the color of the toner cartridge, visit the Brother Solutions Center at support.brother.com and view the FAQs & Troubleshooting page for your Brother model. <i>See Related Information: Replace the Toner Cartridge.</i> • Install a new drum unit. <i>See Related Information: Replace the Drum Unit.</i>
 <p data-bbox="229 1272 724 1305">Horizontal colored lines appear on the page</p>	<ul data-bbox="820 1008 1461 1283" style="list-style-type: none"> • Identify the color causing the problem and replace the toner cartridge that matches the color of the line. To identify the color of the toner cartridge, visit the Brother Solutions Center at support.brother.com to see the FAQs & Troubleshooting page. <i>See Related Information: Replace the Toner Cartridge.</i> • Install a new drum unit. <i>See Related Information: Replace the Drum Unit.</i>
 <p data-bbox="408 1592 544 1626">White spots</p>	<ul data-bbox="820 1323 1461 1693" style="list-style-type: none"> • Make sure the media type setting in the printer driver matches the type of paper you are using. • Check the machine's environment. Conditions such as high humidity can cause hollow print. • If the problem is not solved after printing a few pages, the drum may have foreign material, such as glue from a label, stuck on the drum surface. Clean the drum unit. <i>See Related Information: Clean the Drum Unit.</i> • Install a new drum unit. <i>See Related Information: Replace the Drum Unit.</i>
 <p data-bbox="277 1984 676 2018">Blank page or some missing colors</p>	<ul data-bbox="820 1715 1461 1995" style="list-style-type: none"> • Identify the color causing the problem and install a new toner cartridge. To identify the color of the toner cartridge, visit the Brother Solutions Center at support.brother.com to see the FAQs & Troubleshooting page. <i>See Related Information: Replace the Toner Cartridge.</i> • Install a new drum unit. <i>See Related Information: Replace the Drum Unit.</i>

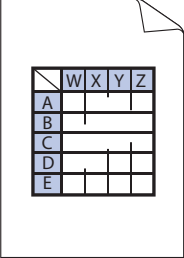
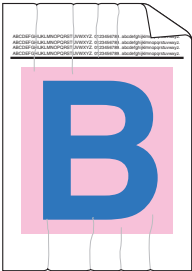
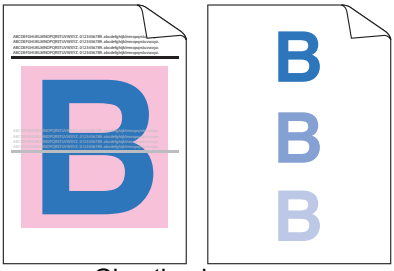
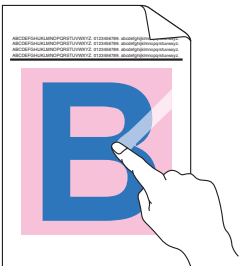
Examples of poor print quality	Recommendation
 <p>3.7 in. (94 mm)</p> <p>3.7 in. (94 mm)</p> <p>Colored spots at 3.7 in. (94 mm)</p>	<ul style="list-style-type: none"> If the problem is not solved after printing a few pages, the drum may have foreign material, such as glue from a label, stuck on the drum surface. Clean the drum unit. <i>See Related Information: Clean the Drum Unit.</i> Install a new drum unit. <i>See Related Information: Replace the Drum Unit.</i>
 <p>1.1 in. (29 mm)</p> <p>1.1 in. (29 mm)</p> <p>Colored spots at 1.1 in. (29 mm)</p>	<ul style="list-style-type: none"> Identify the color causing the problem and install a new toner cartridge. To identify the color of the toner cartridge, visit the Brother Solutions Center at support.brother.com to see the FAQs & Troubleshooting page. <i>See Related Information: Replace the Toner Cartridge.</i>
 <p>Toner scatter or toner stain</p>	<ul style="list-style-type: none"> Check the machine's environment. Conditions such as high humidity and high temperatures may cause this print quality problem. Identify the color causing the problem and put in a new toner cartridge. To identify the color of the toner cartridge, visit the Brother Solutions Center at support.brother.com to see the FAQs & Troubleshooting page. <i>See Related Information: Replace the Toner Cartridge.</i> Install a new drum unit. <i>See Related Information: Replace the Drum Unit.</i>
<p>The color of your printouts is not what you expected</p>	<ul style="list-style-type: none"> To improve the color density, calibrate the colors using the LCD. To adjust the print position of colors for sharper edges, perform the color registration using the LCD. Make sure Toner Save mode is off in the LCD or the printer driver. If the print quality of the black portion is not what you expected, select the Enhance Black Printing check box in the printer driver. Clear the Improve Gray Color check box in the printer driver. Identify the color causing the problem and put in a new toner cartridge. To identify the color of the toner cartridge, visit the Brother Solutions Center at support.brother.com to see the FAQs & Troubleshooting page. <i>See Related Information: Replace the Toner Cartridge.</i> Install a new drum unit. <i>See Related Information: Replace the Drum Unit.</i>

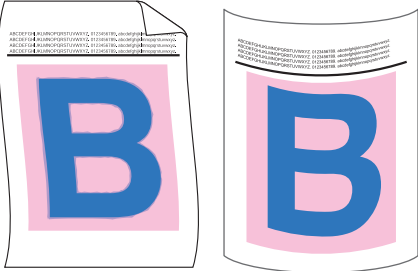
Examples of poor print quality	Recommendation
 <p data-bbox="411 439 544 465">Color offset</p>	<ul data-bbox="820 170 1422 394" style="list-style-type: none"> • Make sure the machine is on a solid level surface. • Perform the color registration using the LCD. • Install a new drum unit. <i>See Related Information: Replace the Drum Unit.</i> • Install a new belt unit. <i>See Related Information: Replace the Belt Unit.</i>
 <p data-bbox="261 752 689 779">Uneven color density across the page</p>	<ul data-bbox="820 483 1422 864" style="list-style-type: none"> • Perform the calibration using the LCD. • Clear the Improve Gray Color check box in the printer driver. • Identify the color causing the problem and put in a new toner cartridge. To identify the color of the toner cartridge, visit the Brother Solutions Center at support.brother.com to see the FAQs & Troubleshooting page. <i>See Related Information: Replace the Toner Cartridge.</i> • Install a new drum unit. <i>See Related Information: Replace the Drum Unit.</i>
 <p data-bbox="320 1144 632 1171">Missing thin lines in images</p>	<ul data-bbox="820 887 1453 1055" style="list-style-type: none"> • Make sure Toner Save mode is off in the LCD or the printer driver. • Change the print resolution. • If you use a Windows printer driver, choose Improve Pattern Printing in Print Setting of the Basic tab.
 <p data-bbox="379 1458 571 1485">Wrinkled printout</p>	<ul data-bbox="820 1189 1453 1402" style="list-style-type: none"> • Check the paper type and quality. • Make sure the back cover is closed correctly. • Make sure the two gray levers inside the back cover are in the up position. • Make sure the media type setting in the printer driver matches the type of paper you are using.
 <p data-bbox="379 1783 571 1809">Ghosting images</p>	<ul data-bbox="820 1503 1469 1805" style="list-style-type: none"> • Check the machine's environment. Conditions such as low humidity and low temperatures may cause this print quality problem. • Make sure the media type setting in the printer driver matches the type of paper you are using. • Make sure the two gray levers inside the back cover are in the up position. • Install a new drum unit. <i>See Related Information: Replace the Drum Unit.</i>
	<ul data-bbox="820 1827 1453 2092" style="list-style-type: none"> • Make sure the two gray levers inside the back cover are in the up position. • Make sure the media type setting in the printer driver matches the type of paper you are using. • Choose Improve Toner Fixing mode in the printer driver. If this selection does not provide enough improvement, change the printer driver setting in

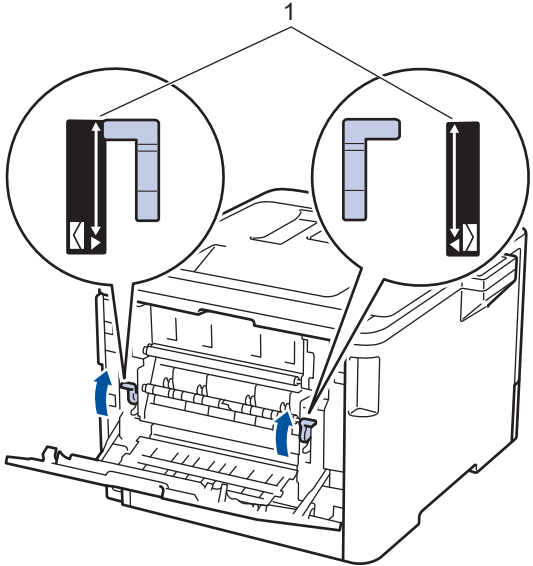
Examples of poor print quality	Recommendation
<p>Toner smears easily</p>	<p>Media Type to a thick setting. If you are printing an envelope, choose Env. Thick in the media type setting.</p>
 <p>Curled or wavy image</p>	<ul style="list-style-type: none"> • Choose Reduce Paper Curl mode in the printer driver. • If the problem is not solved, choose Plain Paper in the media type setting. • If you are printing an envelope, choose Env. Thin in the Media Type Setting of the printer driver. • If you do not use the machine often, the paper may have been in the paper tray too long. Turn over the stack of paper in the paper tray. Also, fan the paper stack and then rotate the paper 180° in the paper tray. • Store the paper where it will not be exposed to high temperatures and high humidity. • Open the back cover (Face up output tray) to let the printed paper exit onto the Face up output tray.
 <p>Envelope creases</p>	<ul style="list-style-type: none"> • Make sure the envelope levers inside the back cover are pulled down to the envelope position when you print envelopes. <p>NOTE</p> <p>When you have finished printing, open the back cover and reset the two gray levers back to their original position (1) by lifting them up until they stop.</p>  <ul style="list-style-type: none"> • If creases occur with the envelope levers in the envelope position, print with the back cover open and feed one envelope at a time from the MP tray.



Related Information

- [Troubleshooting](#)
- [Recommended Print Media](#)
- [Test Print](#)
- [Calibrate Color Output](#)
- [Replace the Toner Cartridge](#)

-
- Reduce Toner Consumption
 - Replace the Drum Unit
 - Clean the Drum Unit
 - Replace the Belt Unit
-

Network Problems

- [Error Messages](#)
- [Use the Network Connection Repair Tool \(Windows®\)](#)
- [Where Can I Find My Brother Machine's Network Settings?](#)
- [I Cannot Complete the Wireless Network Setup Configuration](#)
- [My Brother Machine Cannot Print over the Network](#)
- [I Want to Check that My Network Devices are Working Correctly](#)

Error Messages

Your Brother machine will display an error message if an error occurs. The most common error messages are shown in the table.

Error Messages	Cause	Action
A device is already connected. Press [OK].	Two mobile devices are already connected to the Wi-Fi Direct network when the Brother machine is the Group Owner (G/O).	After the current connection between your Brother machine and another mobile device has shut down, try to configure the Wi-Fi Direct settings again. You can confirm the connection status by printing the Network Configuration Report.
Authentication error, contact your administrator.	Your authentication setting for the Store Print Log to Network feature is not correct.	<ul style="list-style-type: none"> Make sure the Username and Password in Authentication Setting are correct. If the username is part of a domain, enter the username in one of the following styles: user@domain or domain\user. Make sure the SNTP time server settings are configured correctly so the time matches the time used for authentication by Kerberos or NTLMv2.
Check User ID and Password.	The Kerberos Authentication error.	Make sure you have entered a correct user name and a password for the Kerberos server. For more information on the Kerberos server settings, contact your network administrator.
	The DNS server configuration is not correct.	Contact your network administrator for the information on the DNS server settings.
	The Brother machine cannot connect to the Kerberos server.	Contact your network administrator for the information on the Kerberos server settings.
Connection Error	Other devices are trying to connect to the Wi-Fi Direct network at the same time.	Make sure there are no other devices trying to connect to the Wi-Fi Direct network, and then try to configure the Wi-Fi Direct settings again.
Connection Failed	The Brother machine and your mobile device cannot communicate during the Wi-Fi Direct network configuration.	<ul style="list-style-type: none"> Move the mobile device closer to your Brother machine. Move your Brother machine and the mobile device to an obstruction-free area. If you are using the PIN Method of WPS, make sure you have entered the correct PIN.
File access error, contact your administrator.	The Brother machine cannot access the destination folder for the Store Print Log to Network feature.	<ul style="list-style-type: none"> Make sure the stored directory name is correct. Make sure the stored directory is write-enabled. Make sure the file is not locked.
Log Access Error	In Web Based Management, you have selected the Cancel Print option in the Error Detection Setting of Store Print Log to Network .	Wait for about 60 seconds until this message disappears from the LCD.
No Device	When configuring the Wi-Fi Direct network, the Brother machine cannot find your mobile device.	<ul style="list-style-type: none"> Make sure your machine and mobile device are in the Wi-Fi Direct mode. Move the mobile device closer to your Brother machine. Move your Brother machine and the mobile device to an obstruction-free area. If you are manually configuring the Wi-Fi Direct network, make sure you have entered the correct password.

Error Messages	Cause	Action
		<ul style="list-style-type: none"> If your mobile device has a configuration page for how to obtain an IP address, make sure the IP address of your mobile device has been configured via DHCP.
Server timeout, contact your administrator.	The Brother machine cannot connect to the server for the Store Print Log to Network feature.	<ul style="list-style-type: none"> Make sure your server address is correct. Make sure your server is connected to the network. Make sure the machine is connected to the network.
Server Timeout	The Brother machine cannot connect to the LDAP server.	<ul style="list-style-type: none"> Make sure your server address is correct. Make sure your server is connected to the network. Make sure the machine is connected to the network.
	The Brother machine cannot connect to the Active Directory® server.	<ul style="list-style-type: none"> Make sure your server address is correct. Make sure your server is connected to the network. Make sure the machine is connected to the network.
Wrong Date&Time, contact your administrator.	The Brother machine does not obtain the time from the SNTP time server.	<ul style="list-style-type: none"> Make sure the settings to access the SNTP time server are configured correctly in Web Based Management.
Internal Error.	The Brother machine's LDAP protocol is disabled.	Confirm your authentication method, and then enable the necessary protocol setting in the Web Based Management.
	The Brother machine's CIFS protocol is disabled.	



Related Information





- [Network Problems](#)

Use the Network Connection Repair Tool (Windows®)

Use the Network Connection Repair Tool to fix the Brother machine's network settings. It will assign the correct IP address and Subnet Mask.

- Windows® 7/Windows® 8/Windows® 10
You must log on with Administrator rights.
- Make sure the Brother machine is turned on and is connected to the same network as your computer.

1. Do one of the following:

Option	Description
Windows Server® 2008	Click  (Start) > All Programs > Brother > Brother Utilities . Click the drop-down list and select your model name (if not already selected). Click Tools in the left navigation bar, and then click Network Connection Repair Tool .
Windows® 7	Click  (Start) > All Programs > Brother > Brother Utilities . Click the drop-down list and select your model name (if not already selected). Click Tools in the left navigation bar, and then click Network Connection Repair Tool .
Windows® 8/ Windows® 10	Launch  (Brother Utilities), and then click the drop-down list and select your model name (if not already selected). Click Tools in the left navigation bar, and then click Network Connection Repair Tool .
Windows Server® 2012 / 2012 R2 / 2016	Launch  (Brother Utilities), and then click the drop-down list and select your model name (if not already selected). Click Tools in the left navigation bar, and then click Network Connection Repair Tool .



- If the **User Account Control** screen appears, click **Yes**.

2. Follow the on-screen instructions.

3. Check the diagnosis by printing the Network Configuration Report.



The Network Connection Repair Tool will start automatically if you select the **Enable Connection Repair Tool** option in the Status Monitor. Right-click the Status Monitor screen, and then click **Other Settings** > **Enable Connection Repair Tool**. This is not recommended when your network administrator has set the IP address to Static, since it will automatically change the IP address.

If the correct IP address and the Subnet Mask are still not assigned even after using the Network Connection Repair Tool, ask your network administrator for this information.



Related Information

- [Network Problems](#)
- [Print the Network Configuration Report](#)
- [My Brother Machine Cannot Print over the Network](#)
- [I Want to Check that My Network Devices are Working Correctly](#)

Where Can I Find My Brother Machine's Network Settings?

- [Print the Network Configuration Report](#)
- [Change Machine Settings from Your Computer](#)

I Cannot Complete the Wireless Network Setup Configuration

Turn your wireless router off and back on. Then try to configure the wireless settings again. If you are unable to resolve the problem, follow the instructions below:

Investigate the problem using the WLAN Report.

Cause	Action	Interface
Your security settings (SSID/ Network Key) are not correct.	<ul style="list-style-type: none"> • Confirm the security settings using the Wireless Setup Helper utility. For more information and to download the utility, go to your model's Downloads page on the Brother Solutions Center at support.brother.com. • Select and confirm that you are using the correct security settings. <ul style="list-style-type: none"> - See the instructions supplied with your wireless LAN access point/router for information on how to find the security settings. - The manufacturer's name or model number of the wireless LAN access point/router may be used as the default security settings. - Consult with the access point/router manufacturer, your Internet provider, or network administrator. 	Wireless
Your Brother machine's MAC address is not allowed.	Confirm that the Brother machine's MAC Address is allowed in the filter. You can find the MAC Address on your Brother machine's control panel.	Wireless
Your wireless LAN access point/router is in stealth mode (not broadcasting the SSID).	<ul style="list-style-type: none"> • Enter the correct SSID name or Network Key manually. • Check the SSID name or the Network Key in the instructions supplied with your wireless LAN access point/router and reconfigure the wireless network setup. 	Wireless
Your security settings (SSID/ password) are not correct.	<ul style="list-style-type: none"> • Confirm the SSID and password. <ul style="list-style-type: none"> - When you are configuring the network manually, the SSID and password are displayed on your Brother machine. If your mobile device supports the manual configuration, the SSID and password will be displayed on your mobile device's screen. 	Wi-Fi Direct
You are using Android™ 4.0.	If your mobile device disconnects (approximately six minutes after using Wi-Fi Direct), try the one-push configuration using WPS (recommended) and set the Brother machine as a G/O.	Wi-Fi Direct
Your Brother machine is placed too far from your mobile device.	Move your Brother machine within about 3.3 feet (1 meter) of the mobile device when you configure the Wi-Fi Direct network settings.	Wi-Fi Direct
There are some obstructions (walls or furniture, for example) between your machine and the mobile device.	Move your Brother machine to an obstruction-free area.	Wi-Fi Direct
There is a wireless computer, Bluetooth-supported device, microwave oven, or digital cordless phone near the Brother machine or the mobile device.	Move other devices away from the Brother machine or the mobile device.	Wi-Fi Direct
If you have checked and tried all of the above, but still cannot complete the Wi-Fi	<ul style="list-style-type: none"> • Turn your Brother machine off and back on. Then try to configure the Wi-Fi Direct settings again. 	Wi-Fi Direct

Cause	Action	Interface
Direct configuration, do the following:	<ul style="list-style-type: none">• If you are using your Brother machine as a client, confirm how many devices are allowed in the current Wi-Fi Direct network, and then check how many devices are connected.	

For Windows®



If your wireless connection has been interrupted, and you have checked and tried all of the above, we recommend using the Network Connection Repair Tool.



Related Information

- [Network Problems](#)
 - [Configure Your Machine for a Wireless Network When the SSID Is Not Broadcast](#)
 - [Use Wi-Fi Direct®](#)
-

My Brother Machine Cannot Print over the Network

Cause	Action	Interface
Your security software blocks your machine's access to the network.	Some security software might block access without showing a security alert dialog box even after successful installation. To allow access, see the instructions for your security software or ask the software manufacturer.	Wired/Wireless
Your Brother machine was not assigned an available IP address.	<ul style="list-style-type: none"> Confirm the IP address and the Subnet Mask. Verify that both the IP addresses and Subnet Masks of your computer and the Brother machine are correct and located on the same network. For more information about how to verify the IP address and the Subnet Mask, ask your network administrator. Windows® Confirm the IP address and the Subnet Mask using the Network Connection Repair Tool. 	Wired/Wireless
The failed print job is still in your computer's print queue.	<ul style="list-style-type: none"> If the failed print job is still in your computer's print queue, delete it. Otherwise, double-click the printer icon in the following folder and cancel all documents: <ul style="list-style-type: none"> Windows® 7 Click  (Start) > Devices and Printers > Printers and Faxes. Windows® 8 Move your mouse to the lower right corner of your desktop. When the menu bar appears, click Settings > Control Panel. In the Hardware and Sound group, click View devices and printers > Printers. Windows® 10 and Windows Server® 2016 Click  > Windows System > Control Panel. In the Hardware and Sound group, click View devices and printers > Printers. Windows Server® 2008 Click Start > Control Panel > Printers. Windows Server® 2012 Move your mouse to the lower right corner of your desktop. When the menu bar appears, click Settings > Control Panel. In the Hardware group, click View devices and printers > Printers. Windows Server® 2012 R2 Click Control Panel on the Start screen. In the Hardware group, click View devices and printers. macOS v10.10.5, v10.11.x, v10.12 Click System Preferences > Printers & Scanners. 	Wired/Wireless
Your Brother machine is not connected to the wireless network.	Print the WLAN Report to check the error code on the printed report.	Wireless

If you have checked and tried all of the above, but your Brother machine still cannot print, uninstall the printer driver and reinstall it.



Related Information

- [Network Problems](#)

-
- [Print the WLAN Report](#)
 - [Wireless LAN Report Error Codes](#)
 - [Use the Network Connection Repair Tool \(Windows®\)](#)
 - [I Want to Check that My Network Devices are Working Correctly](#)
-

I Want to Check that My Network Devices are Working Correctly

Check	Action	Interface
Check that your Brother machine, access point/router, or network hub is turned on.	<p>Check the following:</p> <ul style="list-style-type: none"> The power cord is connected correctly and the Brother machine is turned on. The access point/router or hub is turned on and its link button is blinking. All protective packaging has been removed from the machine. The toner cartridge and drum unit are installed correctly. The front and back covers are fully closed. Paper is inserted correctly in the paper tray. (For wired networks) A network cable is securely connected to the Brother machine and to the router or hub. 	Wired/Wireless
Check the Link Status in the Network Configuration Report.	Print the Network Configuration Report and check that Ethernet Link Status or Wireless Link Status is Link OK .	Wired/Wireless
Check that you can "ping" the Brother machine from your computer.	<p>Ping the Brother machine from your computer using the IP address or the node name in the Windows® command prompt or Macintosh Terminal application:</p> <p>ping <ipaddress> or <nodename>.</p> <ul style="list-style-type: none"> Successful: Your Brother machine is working correctly and connected to the same network as your computer. Unsuccessful: Your Brother machine is not connected to the same network as your computer. <p>(Windows®) Ask the network administrator and use the Network Connection Repair Tool to fix the IP address and the subnet mask.</p> <p>(Macintosh) Confirm that the IP address and the Subnet Mask are set correctly.</p>	Wired/Wireless
Check that your Brother machine is connected to the wireless network.	Print the WLAN Report to check the error code on the printed report.	Wireless

If you have checked and tried all of the above but you are still having problems, see the instructions supplied with your wireless LAN access point/router to find the SSID and the Network Key information and set them correctly.



Related Information

- [Network Problems](#)
- [Print the Network Configuration Report](#)
- [Print the WLAN Report](#)
- [Wireless LAN Report Error Codes](#)
- [Use the Network Connection Repair Tool \(Windows®\)](#)
- [My Brother Machine Cannot Print over the Network](#)

Google Cloud Print Problems

Difficulty	Suggestions
My Brother machine is not displayed in the printer list.	Make sure your machine is turned on.
	Confirm that Google Cloud Print™ is enabled.
	Confirm that your machine is registered with Google Cloud Print™. If it is not registered, try to register again.
I cannot print.	Make sure your machine is turned on.
	Confirm your network settings. See <i>Related Information</i> .
	Certain files may not be printable, or may not appear exactly as they are displayed.
I cannot register my Brother machine with Google Cloud Print™.	Make sure your machine is connected to a network with Internet access.
	Verify that the date and time are set correctly on your machine.
I do not see a confirmation message on my Brother machine when I try to register with Google Cloud Print™, even after repeating the registration steps.	Make sure your Brother machine is idle while you are registering with Google Cloud Print™.



Related Information

- [Troubleshooting](#)
- [Network Settings for Using Google Cloud Print](#)

AirPrint Problems







Difficulty	Suggestions
My Brother machine is not displayed in the printer list.	Make sure your Brother machine is turned on.
	Confirm the network settings. See <i>Related Information</i> .
	Move the mobile device closer to the wireless access point/router, or to your Brother machine.
I cannot print.	Make sure your Brother machine is turned on.
	Confirm the network settings. See <i>Related Information</i> .
I am trying to print a multiple-page document from an Apple device, but ONLY the first page is printing.	Make sure you are running the latest version of iOS. Refer to the following Apple support article for more information about AirPrint: support.apple.com/kb/HT4356 .



Related Information

- [Troubleshooting](#)
- [AirPrint Overview](#)
- [Network Settings for Using AirPrint](#)

Other Problems

Difficulties	Suggestions
<p>The machine will not turn on.</p>	<p>Adverse conditions on the power connection (such as lightning or a power surge) may have triggered the machine's internal safety mechanisms. Unplug the power cord. Wait for ten minutes, then plug in the power cord and press  to turn on the machine.</p> <p>If the problem is not solved, press and hold  to turn off the machine. If you are using a backup battery or surge suppressor device, disconnect it to make sure it is not the problem. Plug the machine's power cord directly into a different known working wall outlet and press  to turn on the machine.</p>
<p>The machine cannot print EPS data that includes binary with the BR-Script3 printer driver.</p>	<p>(Windows®)</p> <p>To print EPS data, do the following:</p> <ol style="list-style-type: none"> For Windows® 7 and Windows Server® 2008 R2: Click the  Start button > Devices and Printers. For Windows Server® 2008: Click the  (Start) button > Control Panel > Hardware and Sound > Printers. For Windows® 8 and Windows Server® 2012: Move your mouse to the lower right corner of your desktop. When the menu bar appears, click Settings > Control Panel. In the Hardware and Sound¹ group, click View devices and printers. For Windows® 10 and Windows Server® 2016: Click  > Windows System > Control Panel. In the Hardware and Sound group, click View devices and printers. For Windows Server® 2012 R2: Click Control Panel on the Start screen. In the Hardware group, click View devices and printers. Right-click the Brother XXX-XXXX BR-Script3 icon, select Printer properties. From the Device Settings tab, choose TBCP (Tagged binary communication protocol) in Output Protocol. <p>(Macintosh)</p> <p>If your machine is connected to a computer with a USB interface, you cannot print EPS data that includes binary. You can print the EPS data at the machine through a network. For help installing the BR-Script3 printer driver through the network, go to the Brother Solutions Center at support.brother.com.</p>
<p>The Brother software cannot be installed.</p>	<p>(Windows®)</p> <p>If the Security Software warning appears on the computer screen during the installation, change the Security Software settings to permit the Brother product setup program or other program to run.</p> <p>(Macintosh)</p>

Difficulties	Suggestions
	If you are using a firewall function of anti-spyware or antivirus security software, temporarily disable it and then install the Brother software.

¹ For Windows Server® 2012: **Hardware and Sound**



Related Information

- [Troubleshooting](#)
-

Check the Machine Information

Follow these instructions to check your Brother machine's serial number and firmware version.

1. Press  [Settings] > [All Settings] > [Machine Information].
2. Press one of the following options:

Option	Description
Serial No.	Check your machine's serial number.
Firmware Version	Check your machine's firmware version.
Page Counter	Check the number of total pages the machine has printed.
Parts Life	Check the percentage of the supplies' life that remains available.

3. Press .



Related Information

- [Troubleshooting](#)

Reset Functions

- [Machine Reset](#)
- [Network Reset](#)
- [Factory Reset](#)

Machine Reset

Use the Machine Reset function to reset the machine's settings to the factory settings.

The network settings and the security settings will not be reset by the Machine Reset function.

1. Press  [Settings] > [All Settings] > [Initial Setup] > [Reset] > [Machine Reset].
2. You will be asked to reboot the machine. Press the option in the table to reboot the machine or to exit the process.

Option	Description
Press Yes for 2 seconds	Reboot the machine. The machine will begin the reset.
No	The machine will exit without rebooting.



If you do not reboot your machine, the reset process will not finish and your settings will remain unchanged.

3. Press .



Related Information

- [Reset Functions](#)

Network Reset

Use the Network Reset function to restore the print server's network settings, such as password and IP address, back to its default factory settings.

- Unplug all the interface cables before you perform a Network Reset.

1. Press  [Settings] > [All Settings] > [Initial Setup] > [Reset] > [Network Reset].
2. You will be asked to reboot the machine. Press the option in the table to reboot the machine or to exit the process.

Option	Description
Press Yes for 2 seconds	Reboot the machine. The machine will begin the reset.
No	The machine will exit without rebooting.



If you do not reboot your machine, the reset process will not finish and your settings will remain unchanged.

3. Press .



Related Information

- [Reset Functions](#)

Factory Reset

Use the Factory Reset function to restore all settings back to the factory settings.

Unplug all the interface cables before you perform a Factory Reset.

1. Press  [Settings] > [All Settings] > [Initial Setup] > [Reset] > [Factory Reset].
2. You will be asked to reboot the machine. Press the option in the table to reboot the machine or to exit the process.

Option	Description
Press Yes for 2 seconds	Reboot the machine. The machine will begin the reset.
No	The machine will exit without rebooting.



If you do not reboot your machine, the reset process will not finish and your settings will remain unchanged.

3. Press .



Related Information

- [Reset Functions](#)

Routine Maintenance

- [Replace Supplies](#)
- [Clean the Machine](#)
- [Calibrate Color Output](#)
- [Correct Color Print Alignment \(Color Registration\)](#)
- [Check the Remaining Part Life](#)
- [Pack and Ship Your Brother Machine](#)
- [Replace Periodic Maintenance Parts](#)

Replace Supplies

You must replace supplies when the machine indicates that the life of the supply is over.

Using non-Brother supplies may affect the print quality, hardware performance, and machine reliability. The toner cartridge and drum unit are two separate supplies. Make sure both are installed as an assembly. The order number of supplies may vary depending on the country.

NOTE

- Be sure to seal up the used supplies tightly in a bag so that toner powder does not spill out of the cartridge.
- Visit www.brother.com/original/index.html for instructions on how to return your used supplies to the Brother collection program. If you choose not to return your used supply, discard the used supply according to local regulations, keeping it separate from domestic waste. If you have questions, contact your local waste disposal office.
- We recommend placing used and new supplies on a piece of paper to prevent accidentally spilling or scattering the material inside.
- If you use paper that is not a direct equivalent for the recommended print media, the life of supplies and machine parts may be reduced.
- The projected life for each of the toner cartridges is based on ISO/IEC 19798. Frequency of replacement will vary depending on the print volume, percentage of coverage, types of media used, and powering on/off the machine.
- Frequency of replacing supplies except toner cartridges will vary depending on the print volume, types of media used, and powering on/off the machine.
- Handle the toner cartridge carefully. If toner scatters on your hands or clothes, immediately wipe or wash it off with cold water.
- To avoid print quality problems, DO NOT touch the shaded parts shown in the illustrations.

Toner cartridge

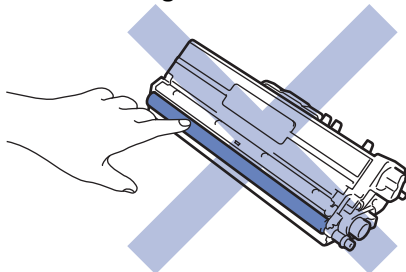

Drum unit

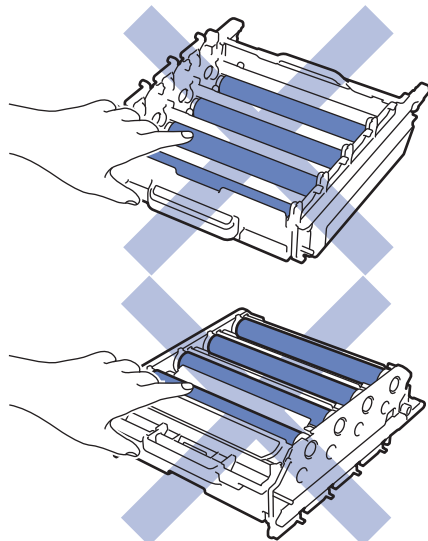

Belt unit

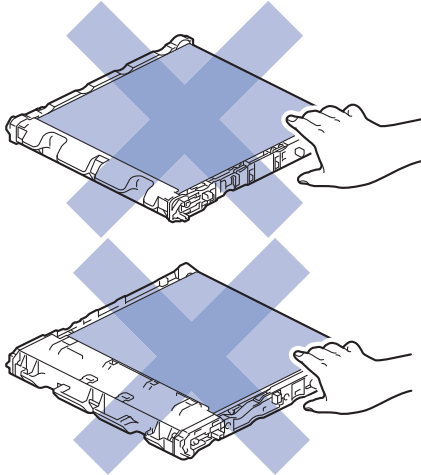

Waste toner box

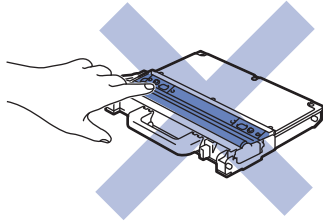

Related Information

- [Routine Maintenance](#)
 - [Replace the Toner Cartridge](#)
 - [Replace the Drum Unit](#)
 - [Replace the Belt Unit](#)
 - [Replace the Waste Toner Box](#)
 - [Reset the Drum Counter](#)
 - [Reset the Belt Unit Counter](#)
 - [Error and Maintenance Messages](#)
 - [Supplies](#)
-

Replace the Toner Cartridge

Before starting the replacement procedure, see *Related Information: Replace Supplies*.

1. Make sure the machine is turned on.
2. Press the front cover release button and pull open the front cover.

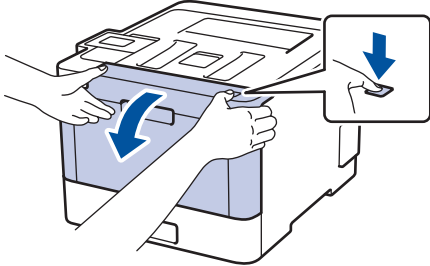

3. Hold the drum unit's green handle. Pull the drum unit out of the machine until it stops.

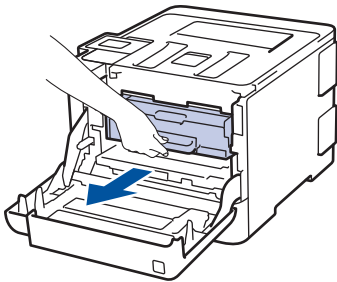

4. Hold the handle of the toner cartridge and gently push it away from you to unlock it. Pull it up and out of the drum unit. Repeat this for all toner cartridges.

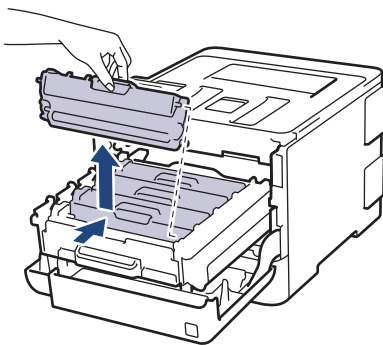

5. Clean the corona wire inside the drum unit by gently sliding the green tab from left to right and right to left several times. Repeat this for all the corona wires.

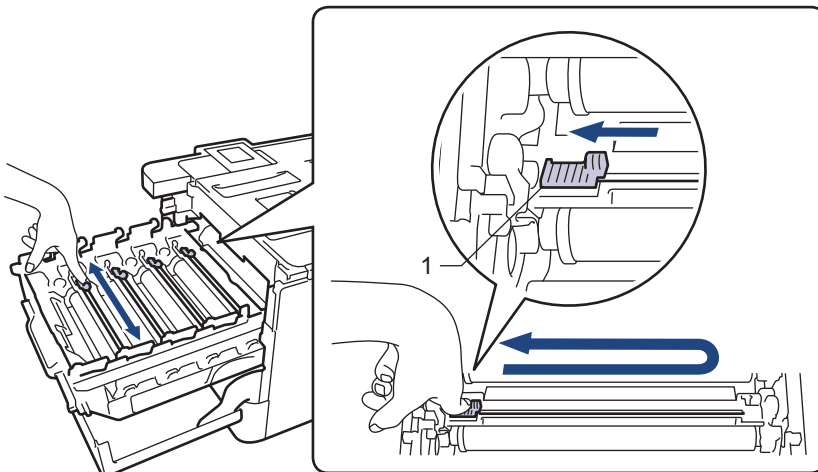

To avoid poor print quality, be sure to lock the green tab into the home position (1), flush left with the left side of the drum.

6. Unpack the new toner cartridge.
7. Remove the protective cover.

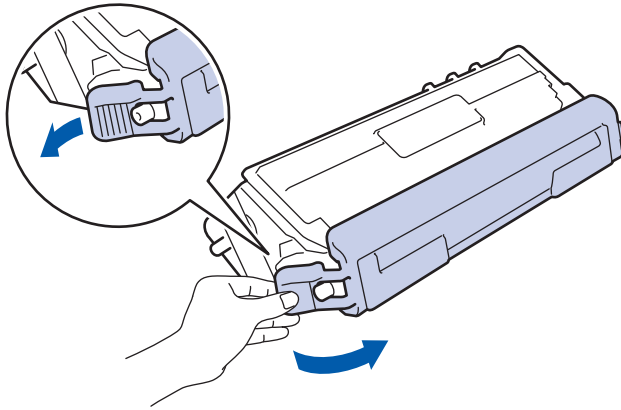

8. Insert the toner cartridge into the drum unit and gently pull it toward you until you hear it lock into place. Make sure that you match the toner cartridge color to the same color label on the drum unit. Repeat this for all toner cartridges.

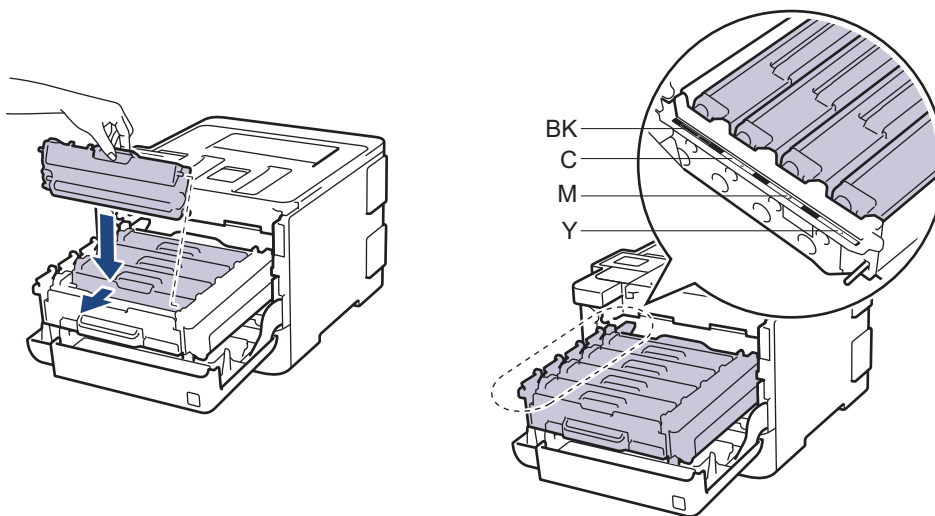

- BK: Black
- C: Cyan
- M: Magenta
- Y: Yellow



Make sure you put the toner cartridge in correctly or it may separate from the drum unit.

9. Using the green handle, push the drum unit back into the machine until it locks in place.

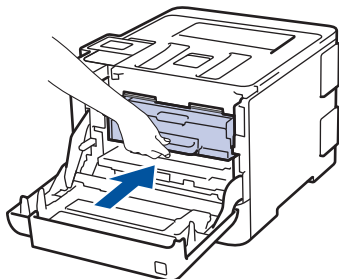

10. Close the machine's front cover.



-
- After replacing a toner cartridge, DO NOT turn off the machine or open the front cover until the machine's display returns to Ready Mode.
 - The toner cartridge that comes with your Brother machine is a Starter toner cartridge.
 - We recommend keeping a new toner cartridge ready for use when you see the Toner Low warning.
 - To ensure high quality printing, we recommend using only Genuine Brother Brand toner cartridges. When you want to buy toner cartridges, contact Brother Customer Service.
 - DO NOT unpack the new toner cartridge until you are ready to install it.
 - If a toner cartridge is left unpacked for a long time, the toner life will be shortened.
 - Brother strongly recommends you DO NOT refill the toner cartridge provided with your machine. We also strongly recommend you continue to use only Genuine Brother Brand replacement toner cartridges. Use or attempted use of third-party toner and/or cartridges in the Brother machine may cause damage to the machine and/or may result in unsatisfactory print quality. Our limited warranty coverage does not apply to any problem that is caused by the use of third party toner and/or cartridges. To protect your investment and obtain premium performance from the Brother machine, we strongly recommend the use of Genuine Brother Supplies.
-



Related Information

- [Replace Supplies](#)
 - [Improve the Print Quality](#)
-

Replace the Drum Unit

Before starting the replacement procedure, see *Related Information: Replace Supplies*.

1. Make sure the machine is turned on.
2. Press the front cover release button and pull open the front cover.

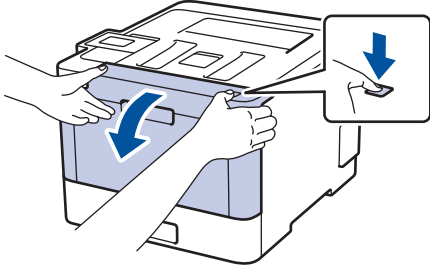

3. Hold the drum unit's green handle. Pull the drum unit out of the machine until it stops.

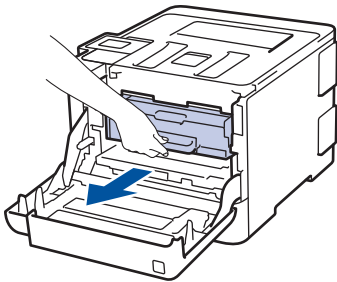

4. Turn the green lock lever (1) counterclockwise until it locks in the release position. Holding the green handles of the drum unit, lift the front of the drum unit and remove it from the machine.

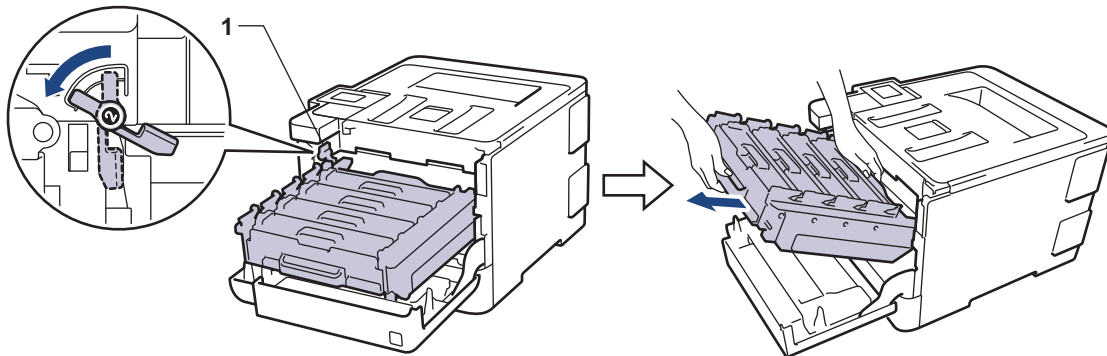

IMPORTANT

Hold the green handles of the drum unit when you carry it. DO NOT hold the sides of the drum unit.

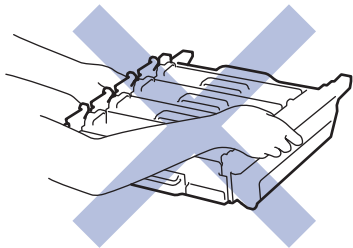

5. Unpack the new drum unit.
6. Remove the protective cover.

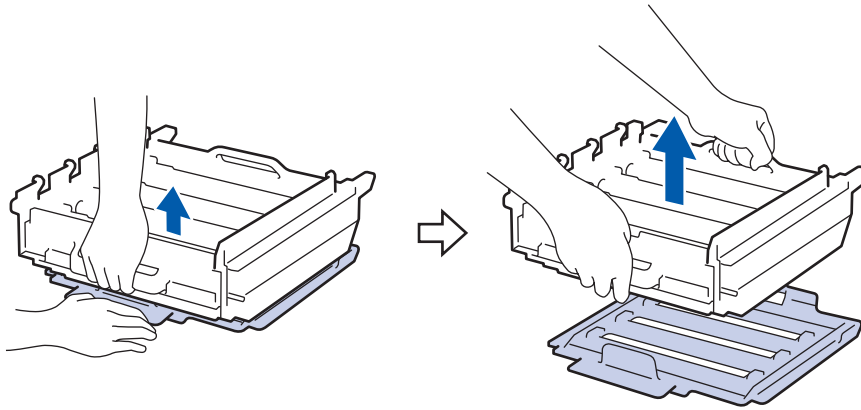

7. Hold the handle of the toner cartridge and gently push it away from you to unlock it. Pull it up and out of the drum unit. Repeat this for all toner cartridges.

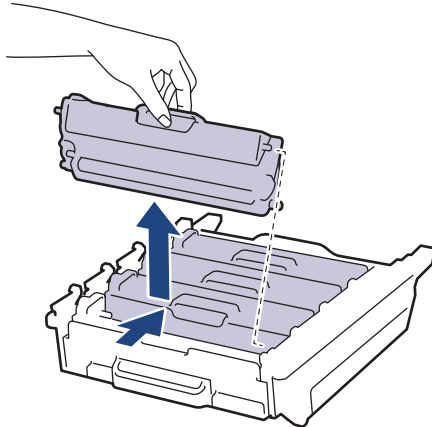

8. Reinsert the toner cartridge into the new drum unit and gently pull it toward you until you hear it lock into place. Make sure that you match the toner cartridge color to the same color label on the drum unit. Repeat this for all toner cartridges.

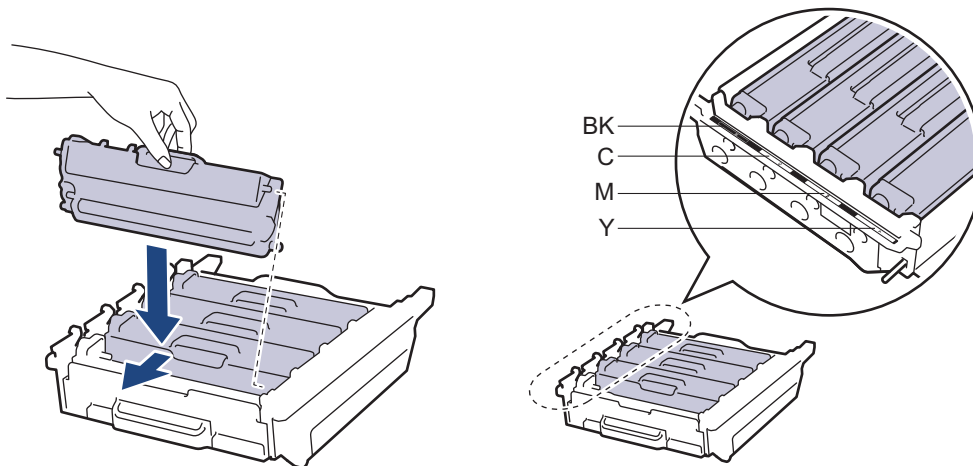

- BK: Black
- C: Cyan
- M: Magenta
- Y: Yellow



Make sure you put the toner cartridge in correctly or it may separate from the drum unit.

9. Make sure the green lock lever (1) is in the release position, as shown in the illustration.

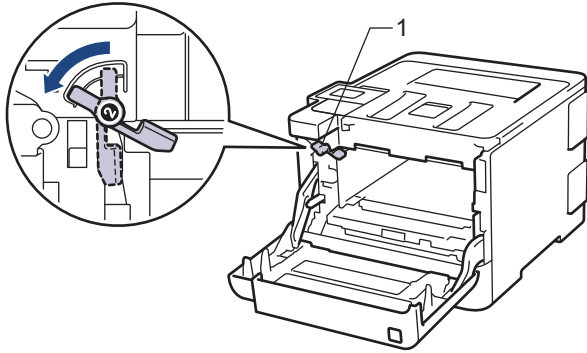

10. Gently slide the drum unit into the machine until it stops at the green lock lever.

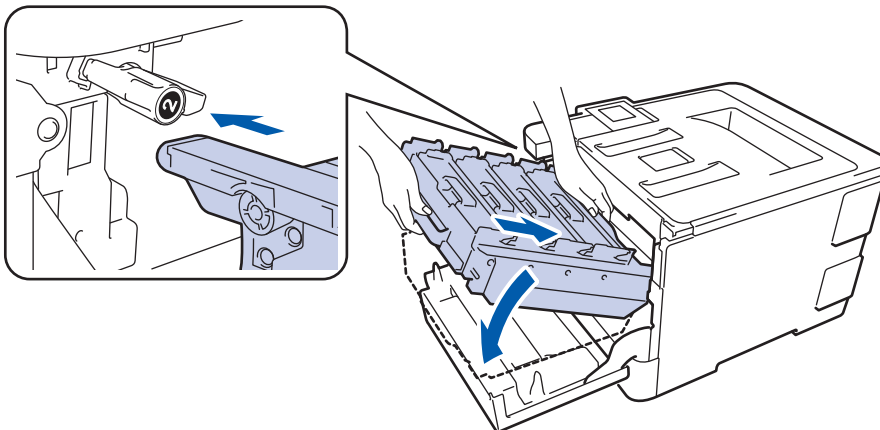

11. Turn the green lock lever clockwise to the lock position.

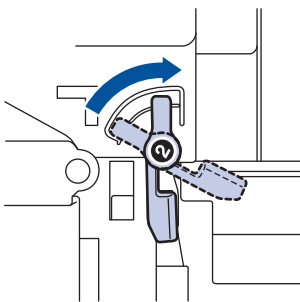

12. Using the green handle, push the drum unit back into the machine until it locks in place.

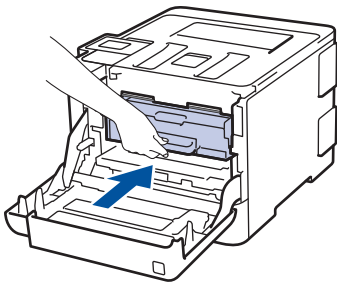

13. Close the machine's front cover.



After installing the new drum unit, you must reset the drum counter. See *Related Information: Reset the Drum Counter*.

NOTE

- Drum wear and tear occurs due to use and rotation of the drum and interaction with paper, toner and other materials in the paper path. In designing this product, Brother decided to use the number of rotations of the drum as a reasonable determinant of the drum life. When a drum reaches the factory-established rotation limit corresponding to the rated page yield, the product's LCD will advise you to replace the drum. The product will continue to function; however, print quality may not be optimal.

-
- If an unpacked drum unit is placed in direct sunlight (or room light for long periods of time), the unit may be damaged.
 - There are many factors that determine the actual drum life, such as the temperature, humidity, type of paper, type of toner used and so on. Under ideal conditions, the average drum life is estimated at approximately 50,000 pages based on 3 pages per job and 30,000 pages based on 1 page per job [A4/letter simplex pages]. The number of pages may be affected due to a variety of factors including but not limited to media type and media size.

Because we have no control over the many factors that determine the actual drum life, we cannot guarantee a minimum number of pages that will be printed by your drum.

- For best performance, use only genuine Brother toner.
- The machine should be used only in a clean, dust-free environment with adequate ventilation.

Printing with a non-Brother drum unit may reduce not only the print quality but also the quality and life of the machine itself. Warranty coverage does not apply to problems caused by the use of a non-Brother drum unit.



Related Information

- [Replace Supplies](#)
 - [Error and Maintenance Messages](#)
 - [Improve the Print Quality](#)
 - [Reset the Drum Counter](#)
-

Replace the Belt Unit

Before starting the replacement procedure, see *Related Information: Replace Supplies*.

1. Make sure the machine is turned on.
2. Press the front cover release button and pull open the front cover.



3. Hold the drum unit's green handle. Pull the drum unit out of the machine until it stops.

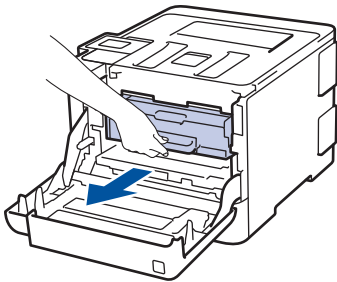

4. Turn the green lock lever (1) counterclockwise until it locks in the release position. Holding the green handles of the drum unit, lift the front of the drum unit and remove it from the machine.

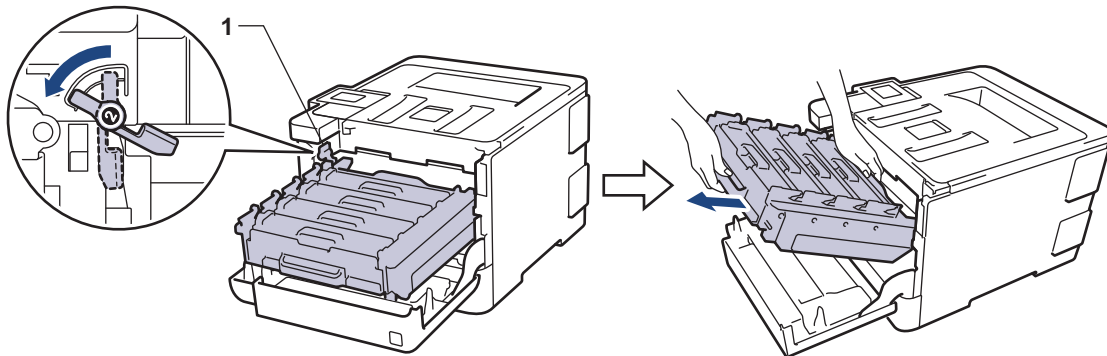

IMPORTANT

Hold the green handles of the drum unit when you carry it. DO NOT hold the sides of the drum unit.

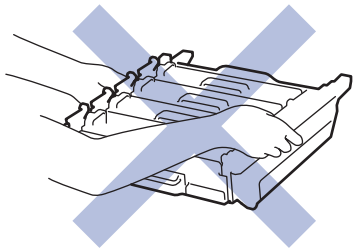

5. Hold the green handle of the belt unit with both hands and lift the belt unit up, then pull it out.

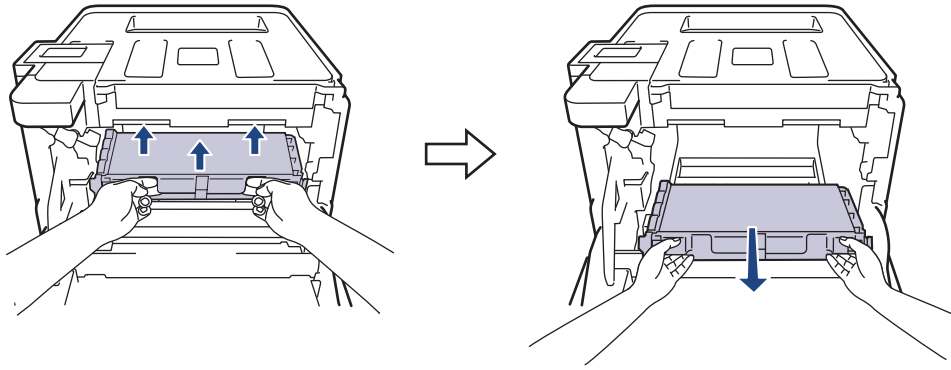

6. Unpack the new belt unit and install the new belt unit in the machine. Make sure the belt unit is level and fits firmly into place.

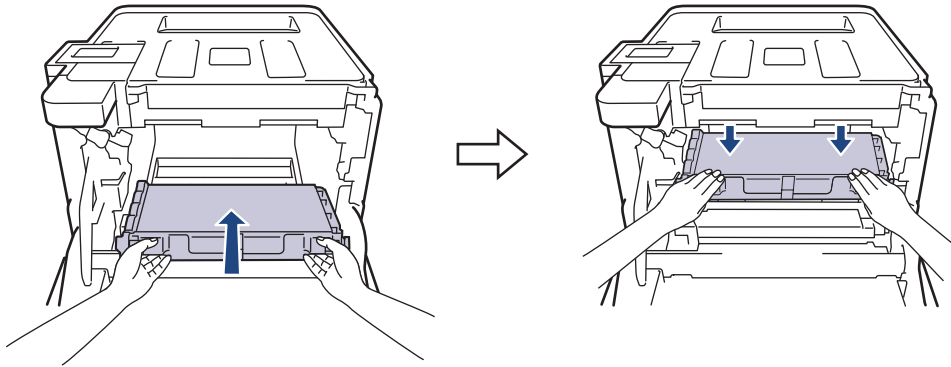

NOTE

To avoid print quality problems, DO NOT touch the shaded parts shown in the illustrations.

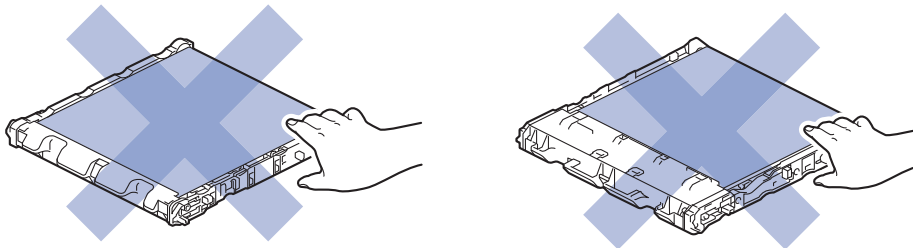

7. Make sure the green lock lever (1) is in the release position, as shown in the illustration.

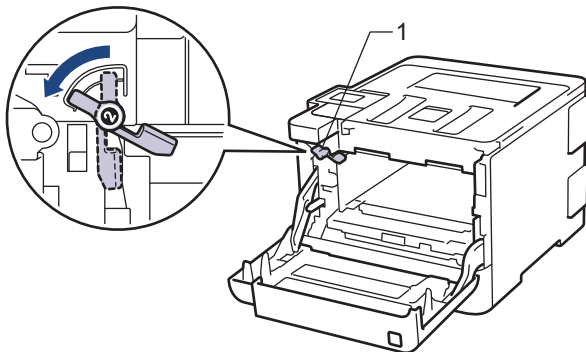

8. Gently slide the drum unit into the machine until it stops at the green lock lever.

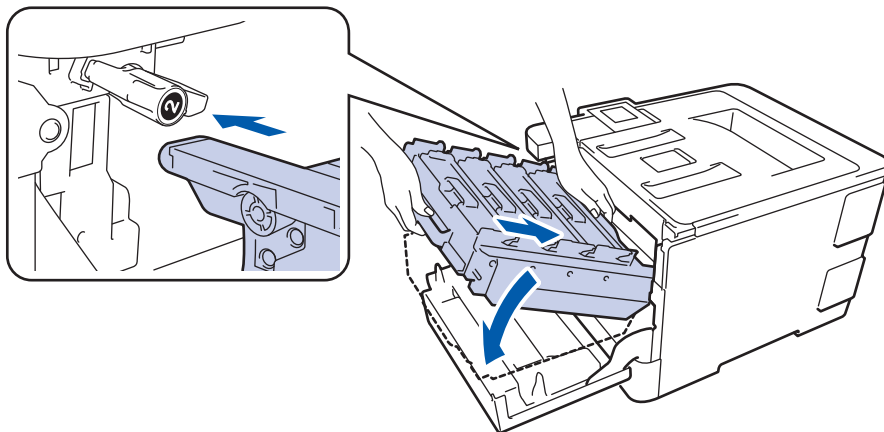

9. Turn the green lock lever clockwise to the lock position.

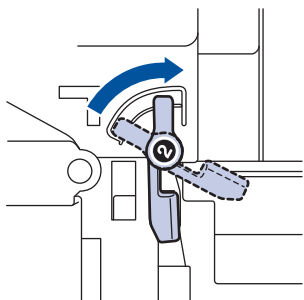

10. Using the green handle, push the drum unit back into the machine until it locks in place.

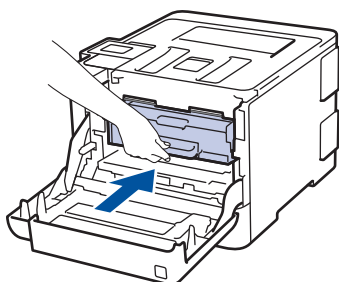

11. Close the machine's front cover.



After installing the new belt unit, you must reset the counter. See *Related Information: Reset the Belt Unit Counter*.



Related Information

- [Replace Supplies](#)
- [Improve the Print Quality](#)
- [Reset the Belt Unit Counter](#)

Replace the Waste Toner Box

Before starting the replacement procedure, see *Related Information: Replace Supplies*.

1. Make sure the machine is turned on.
2. Press the front cover release button and pull open the front cover.



3. Hold the drum unit's green handle. Pull the drum unit out of the machine until it stops.

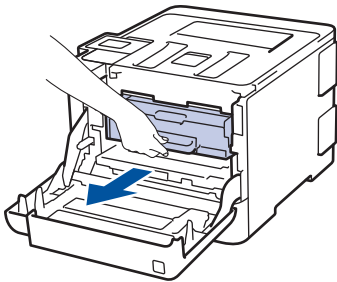

4. Turn the green lock lever (1) counterclockwise until it locks in the release position. Holding the green handles of the drum unit, lift the front of the drum unit and remove it from the machine.

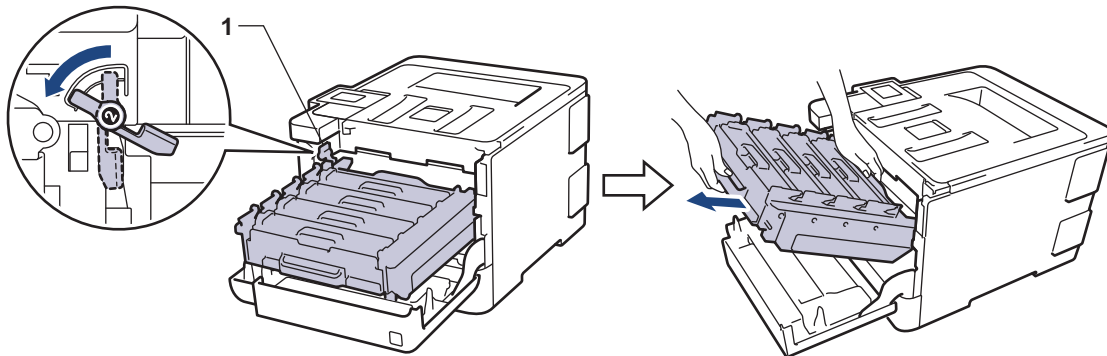

IMPORTANT

Hold the green handles of the drum unit when you carry it. DO NOT hold the sides of the drum unit.

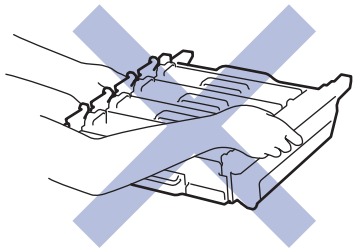

5. Hold the green handle of the belt unit with both hands and lift the belt unit up, then pull it out.

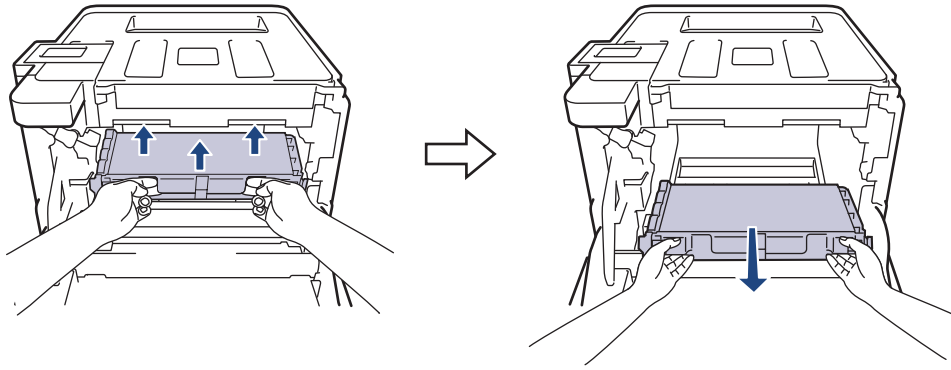

NOTE

To avoid print quality problems, DO NOT touch the shaded parts shown in the illustrations.

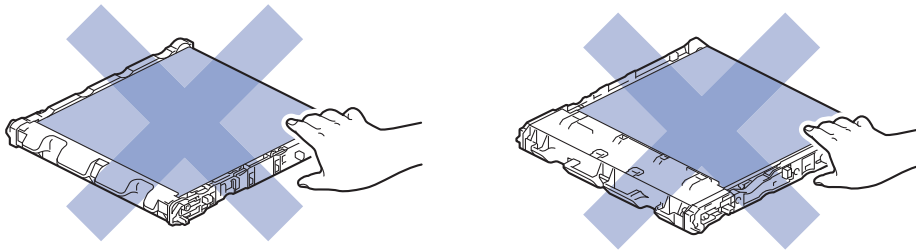

6. Remove the two pieces of orange packing material and discard them.

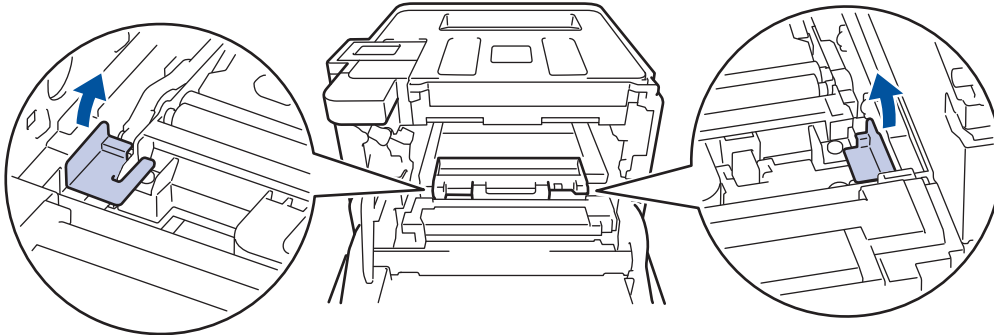

This step is only necessary when you are replacing the waste toner box for the first time, and is not required for the replacement waste toner box. The orange packing pieces are installed at the factory to protect your machine during shipment.

7. Hold the blue handle of the waste toner box and remove the waste toner box from the machine.

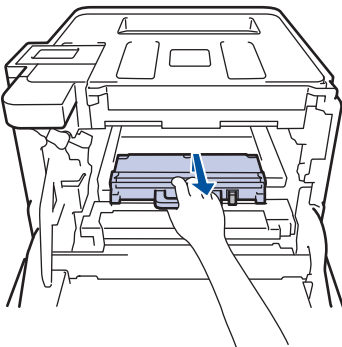

DO NOT reuse the waste toner box.

8. Unpack the new waste toner box and install the new waste toner box in the machine using the blue handle. Make sure the waste toner box is level and fits firmly into place.

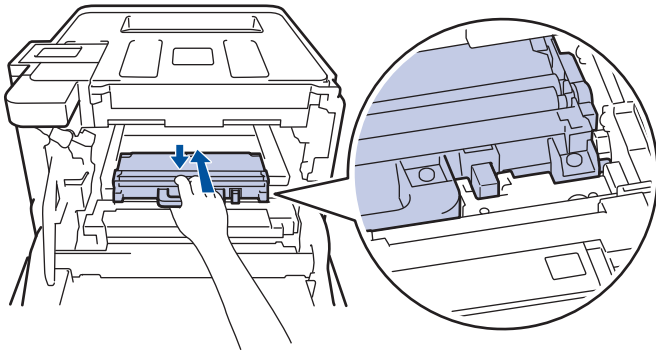

9. Slide the belt unit back into the machine. Make sure the belt unit is level and fits firmly into place.

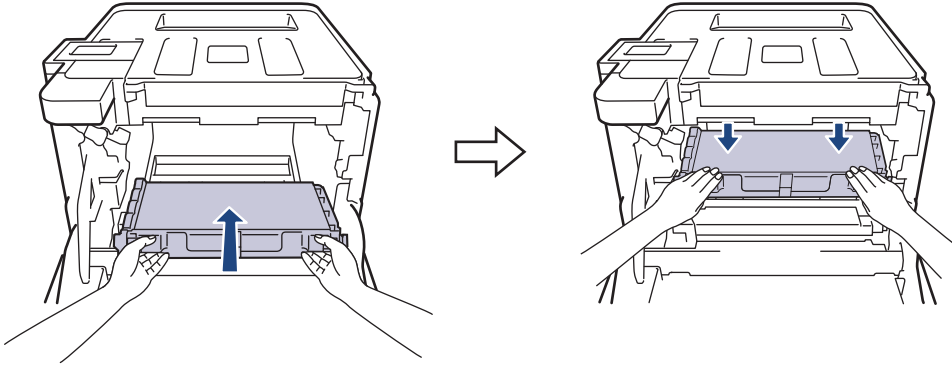

NOTE

To avoid print quality problems, DO NOT touch the shaded parts shown in the illustrations.

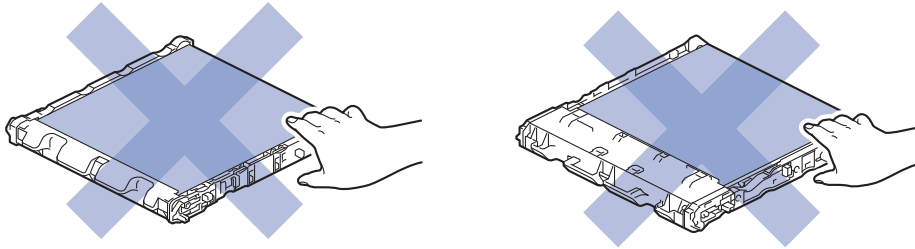

10. Make sure the green lock lever (1) is in the release position, as shown in the illustration.

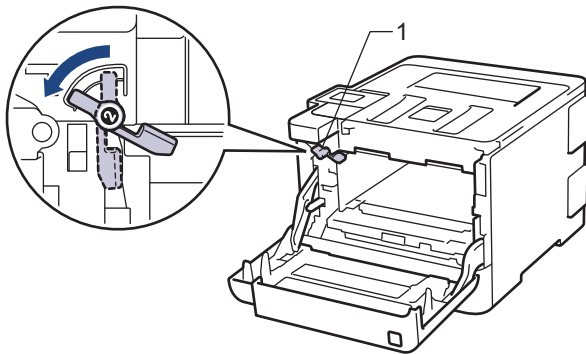

11. Gently slide the drum unit into the machine until it stops at the green lock lever.

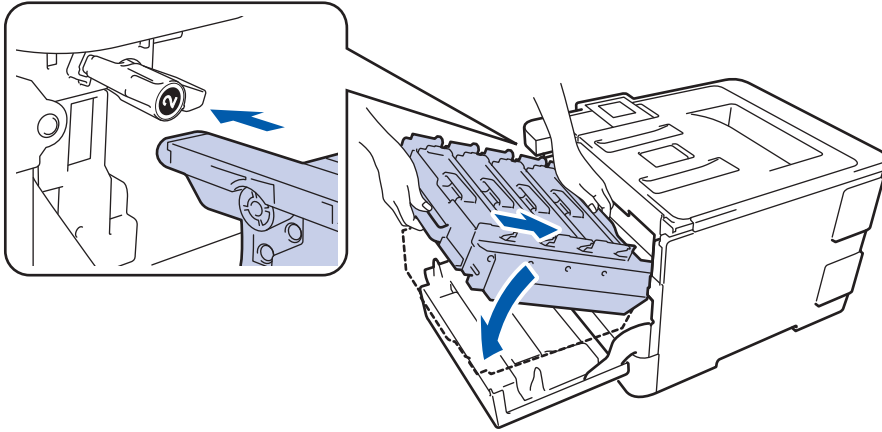

12. Turn the green lock lever clockwise to the lock position.

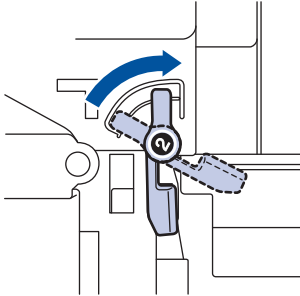

13. Using the green handle, push the drum unit back into the machine until it locks in place.

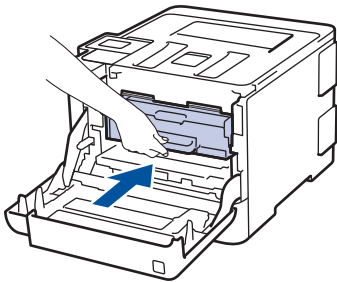

14. Close the machine's front cover.



Related Information



- [Replace Supplies](#)

Reset the Drum Counter

When you replace the drum unit with a new one, you must reset the drum counter by completing the following steps:

IMPORTANT

DO NOT reset the drum counter unless you are replacing the drum unit.



1. Make sure the machine is turned on.
2. Press  [Settings] > [All Settings] > [Machine Information] > [Parts Life].
3. Press and hold [Drum] until the Touchscreen message changes.
4. Press [Yes].
5. Press .

Related Information

- [Replace Supplies](#)
- [Replace the Drum Unit](#)

Reset the Belt Unit Counter

When you replace a belt unit with a new one, you must reset the belt unit counter.

1. Make sure the machine is turned on.
2. Press  [Settings] > [All Settings] > [Machine Information] > [Parts Life].
3. Press and hold [Belt] until the Touchscreen message changes.
4. Press [Yes].
5. Press .



Related Information

- [Replace Supplies](#)
 - [Replace the Belt Unit](#)
-

Clean the Machine

Clean the outside and inside of the machine regularly with a dry, lint-free cloth.

When you replace the toner cartridge or the drum unit, make sure you clean the inside of the machine. If printed pages are stained with toner, clean the inside of the machine with a dry, lint-free cloth.

⚠ WARNING

- DO NOT use flammable substances, any type of spray, or an organic solvent/liquid containing alcohol or ammonia to clean the inside or outside of the product. Doing so could cause a fire. Instead, use only a dry, lint-free cloth.



IMPORTANT

- DO NOT use isopropyl alcohol to remove dirt from the control panel. It may crack the panel.
- To avoid print quality problems, DO NOT touch the shaded parts shown in the illustrations.

Toner cartridge

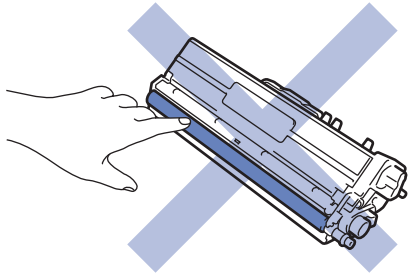

Drum unit

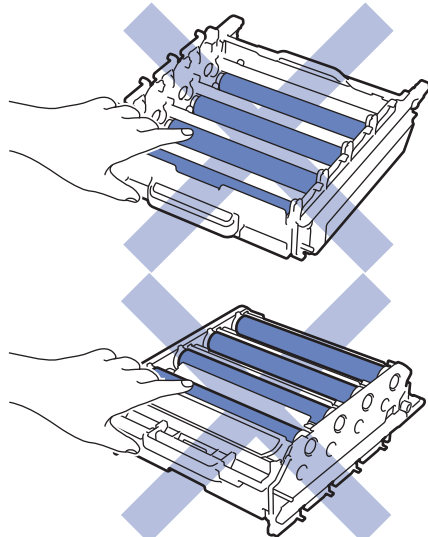

Belt unit

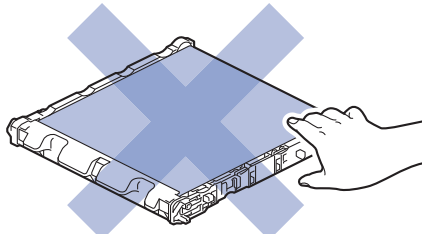

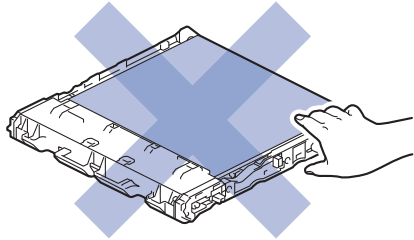

Waste toner box

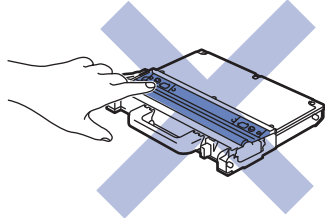

Related Information

- [Routine Maintenance](#)
 - [Clean the Laser Scanner Windows](#)
 - [Clean the Touchscreen LCD](#)
 - [Clean the Corona Wires](#)
 - [Clean the Drum Unit](#)
 - [Clean the Paper Pick-up Rollers](#)
-

Clean the Laser Scanner Windows

1. Press and hold  to turn off the machine.
2. Press the front cover release button and pull open the front cover.

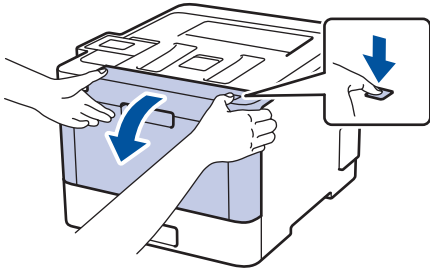

3. Hold the drum unit's green handle. Pull the drum unit out of the machine until it stops.

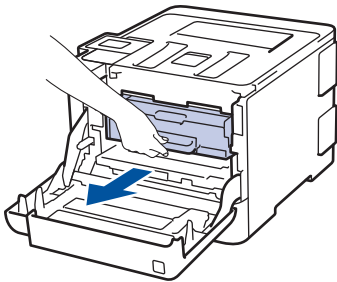

4. Turn the green lock lever (1) counterclockwise until it locks in the release position. Holding the green handles of the drum unit, lift the front of the drum unit and remove it from the machine.

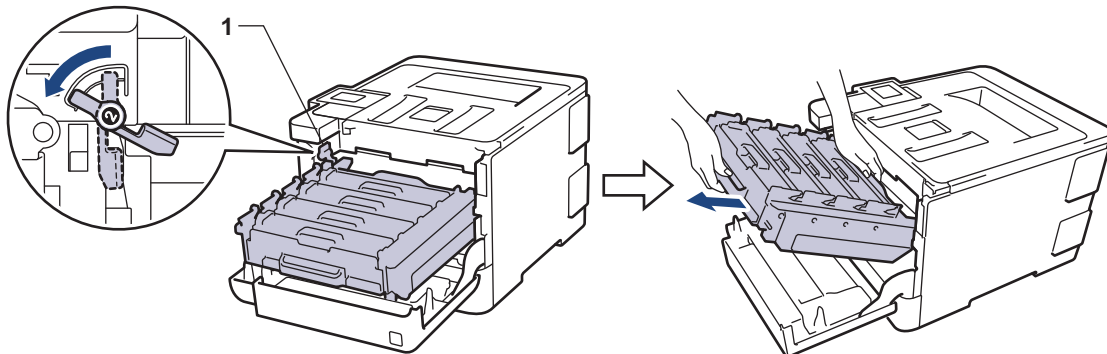

IMPORTANT

Hold the green handles of the drum unit when you carry it. DO NOT hold the sides of the drum unit.

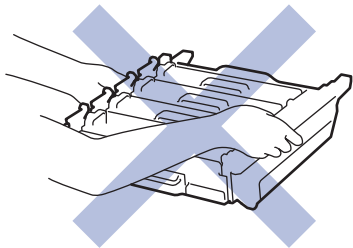

5. Wipe the four laser scanner windows (1) with a dry, soft, lint-free cloth.

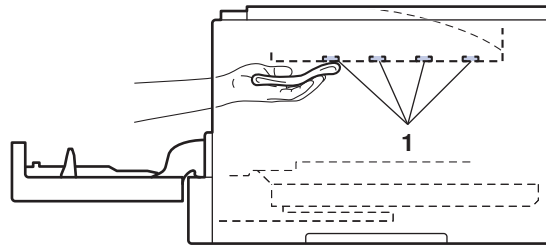
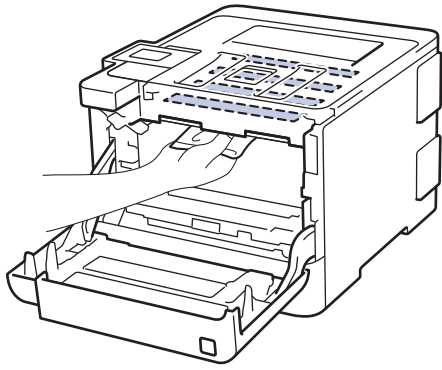

6. Make sure the green lock lever (1) is in the release position, as shown in the illustration.

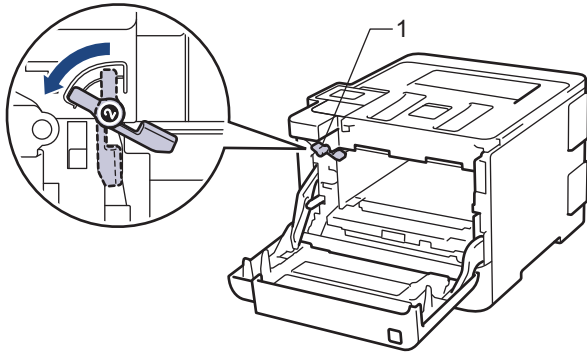

7. Gently slide the drum unit into the machine until it stops at the green lock lever.

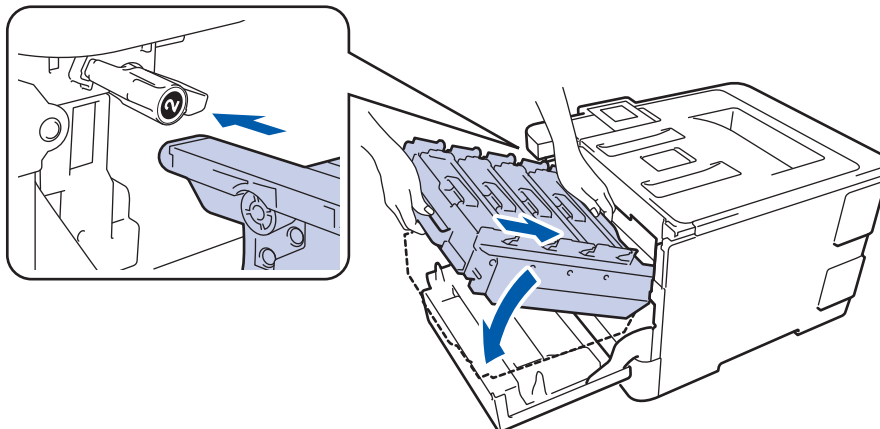

8. Turn the green lock lever clockwise to the lock position.

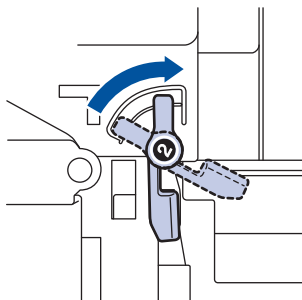

9. Using the green handle, push the drum unit back into the machine until it locks in place.

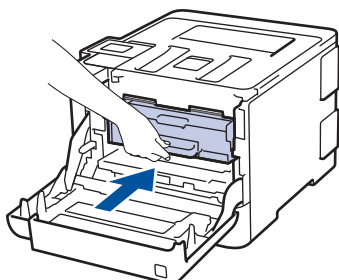

10. Close the machine's front cover.

11. Press  to turn on the machine.



Related Information

- [Clean the Machine](#)
-

Clean the Touchscreen LCD

IMPORTANT

DO NOT use any type of liquid cleaners (including ethanol).

1. Press and hold  to turn off the machine.
2. Clean the Touchscreen with a dry, soft lint-free cloth.

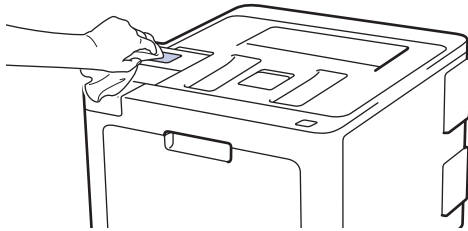

3. Press  to turn on the machine.

Related Information

- [Clean the Machine](#)

Clean the Corona Wires

1. Press the front cover release button and pull open the front cover.

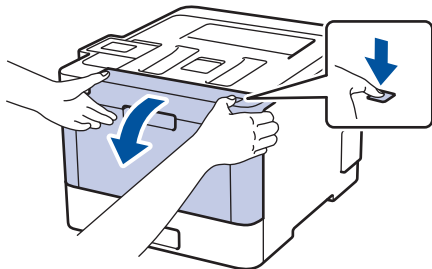

2. Hold the drum unit's green handle. Pull the drum unit out of the machine until it stops.

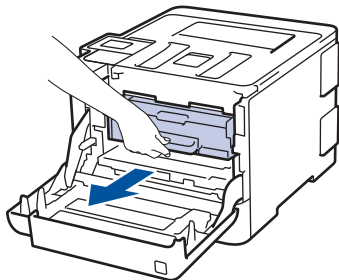

3. Hold the handle of the toner cartridge and gently push it away from you to unlock it. Pull it up and out of the drum unit. Repeat this for all toner cartridges.

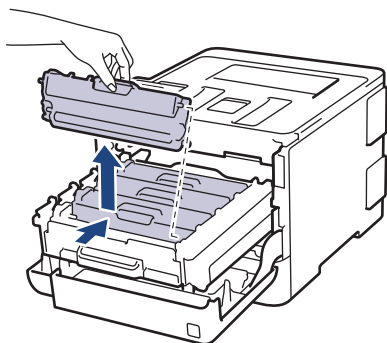

4. Clean the corona wire inside the drum unit by gently sliding the green tab from left to right and right to left several times. Repeat this for all the corona wires.

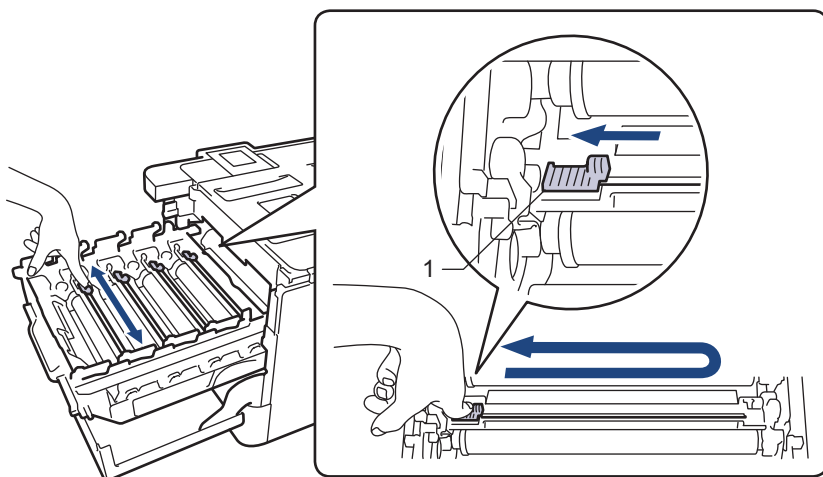

To avoid poor print quality, be sure to lock the green tab into the home position (1), flush left with the left side of the drum.

5. Insert the toner cartridge into the drum unit and gently pull it toward you until you hear it lock into place. Make sure that you match the toner cartridge color to the same color label on the drum unit. Repeat this for all toner cartridges.

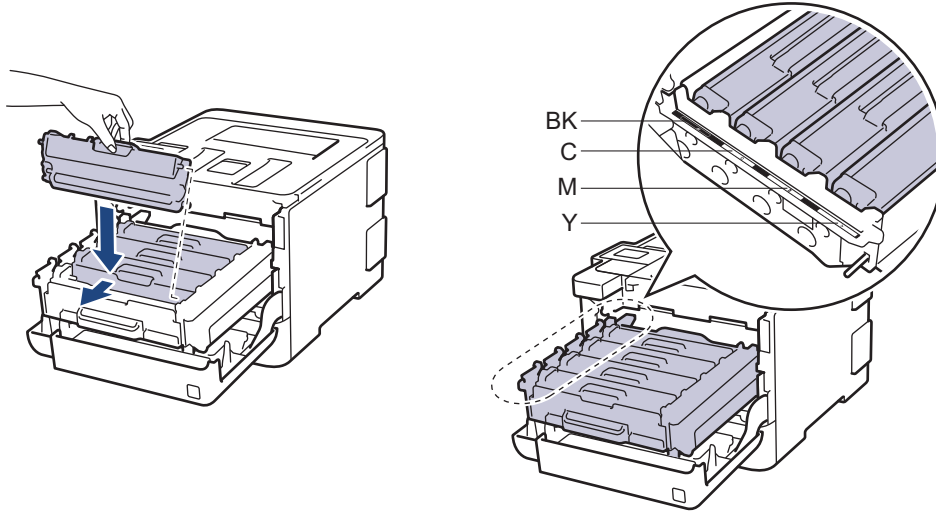

- BK: Black
- C: Cyan
- M: Magenta
- Y: Yellow



Make sure you put the toner cartridge in correctly or it may separate from the drum unit.

6. Using the green handle, push the drum unit back into the machine until it locks in place.

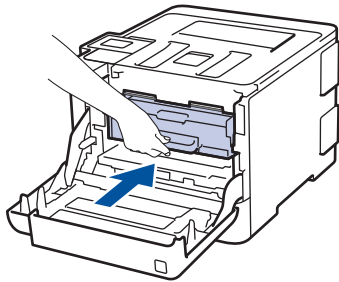

7. Close the machine's front cover.





Related Information

- [Clean the Machine](#)
- [Error and Maintenance Messages](#)

Clean the Drum Unit

If your printout has black or white dots or other repeating marks at 3.7 in. (94 mm) intervals, the drum may have foreign material, such as glue from a label, stuck on the drum surface.

1. Make sure the machine is in Ready Mode.
2. Press  [Settings] > [All Settings] > [Print Reports] > [Drum Dot Print].
3. Press [Yes].
The machine prints the Drum Dot Check Sheet.
4. Press and hold  to turn off the machine.
5. Press the front cover release button and pull open the front cover.

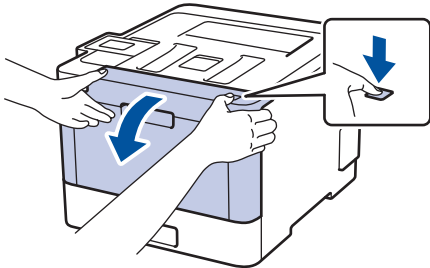

6. Hold the drum unit's green handle. Pull the drum unit out of the machine until it stops.

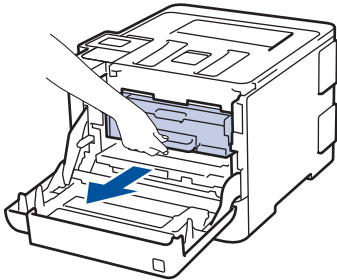

7. Turn the green lock lever (1) counterclockwise until it locks in the release position. Holding the green handles of the drum unit, lift the front of the drum unit and remove it from the machine.

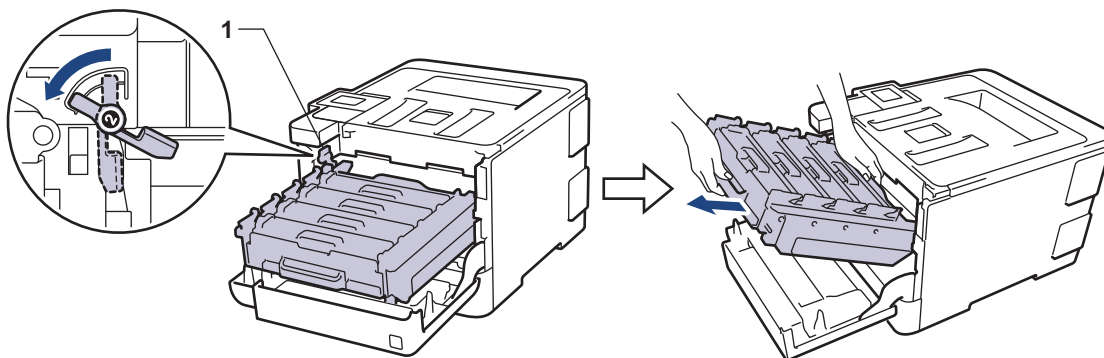

IMPORTANT

Hold the green handles of the drum unit when you carry it. DO NOT hold the sides of the drum unit.

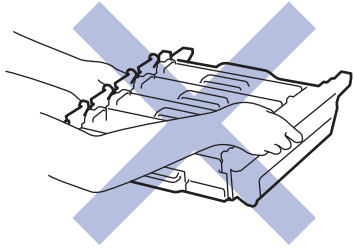

8. Hold the handle of the toner cartridge and gently push it away from you to unlock it. Pull it up and out of the drum unit. Repeat this for all toner cartridges.

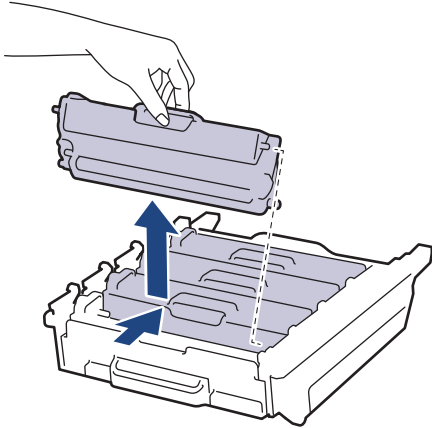

9. Turn the drum unit over by holding the green handles. Make sure that the drum unit gears (1) are on the left side.

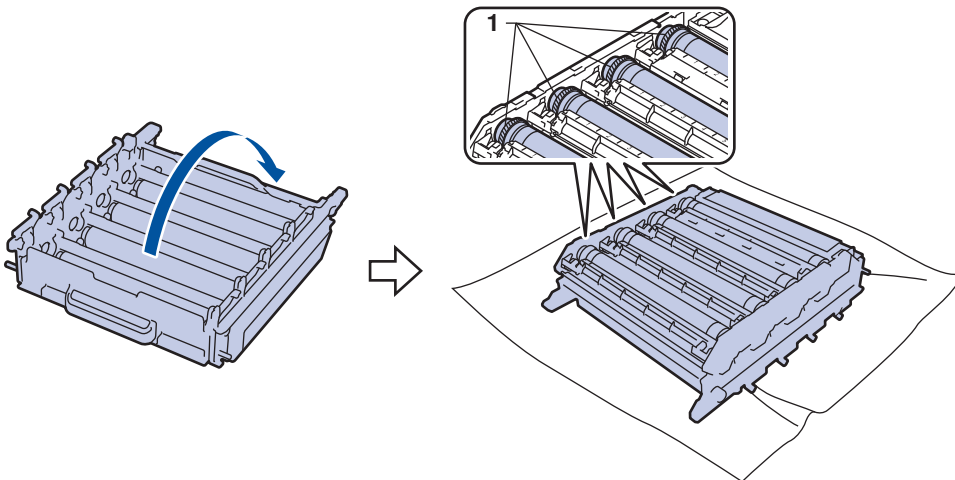

10. Use the numbered markers next to the drum roller to find the mark. For example, a cyan dot in column 2 on the check sheet would mean that there is a mark in the "2" region of the cyan drum.

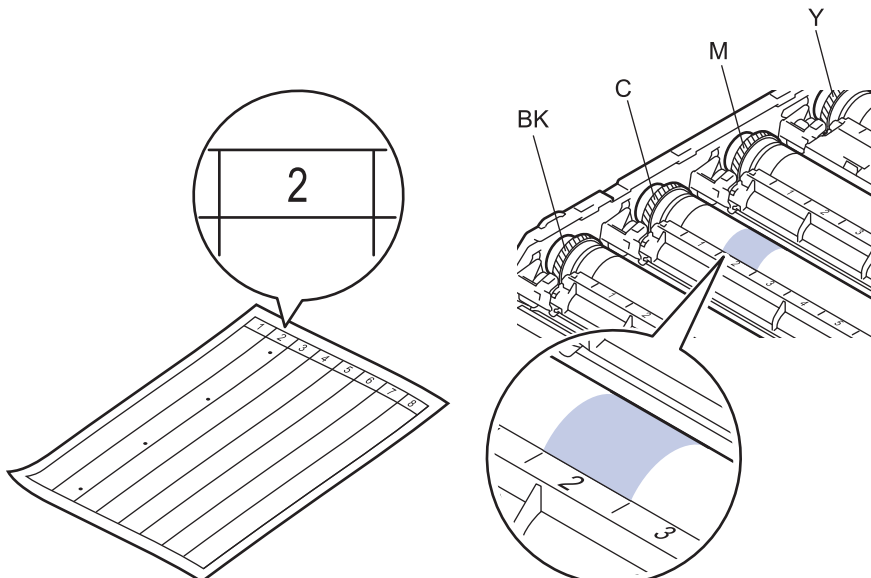

- BK: Black
- C: Cyan
- M: Magenta
- Y: Yellow

11. Hold the drum unit frame with both hands, place your left thumb on the drum unit gear, and roll the drum toward you by hand while looking at the surface of the suspected area.

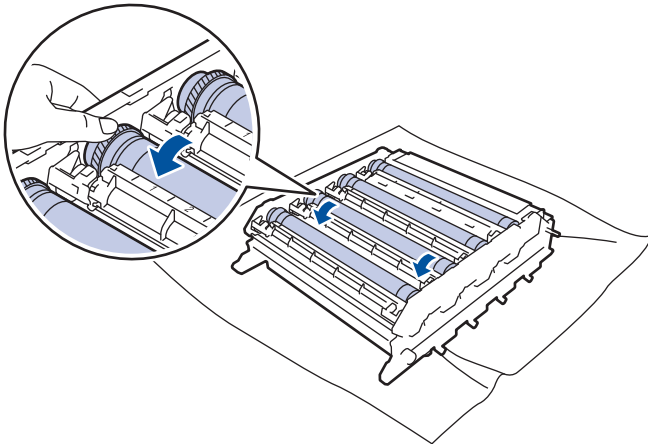

To avoid print quality problems, DO NOT touch the surface of the drum unit except the edge.

12. Wipe the surface of the drum gently with a dry cotton swab until the mark on the surface comes off.

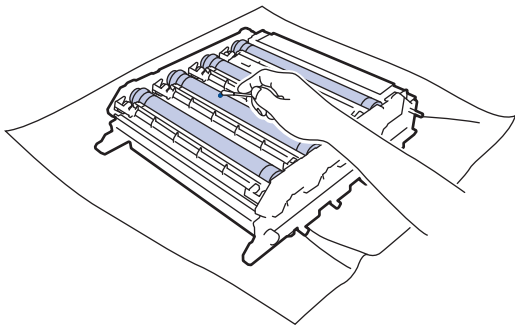

NOTE

DO NOT clean the surface of the photosensitive drum with a sharp object or any liquids.

13. Turn the drum unit over by holding the green handles.

14. Reinsert the toner cartridge into the new drum unit and gently pull it toward you until you hear it lock into place. Make sure that you match the toner cartridge color to the same color label on the drum unit. Repeat this for all toner cartridges.

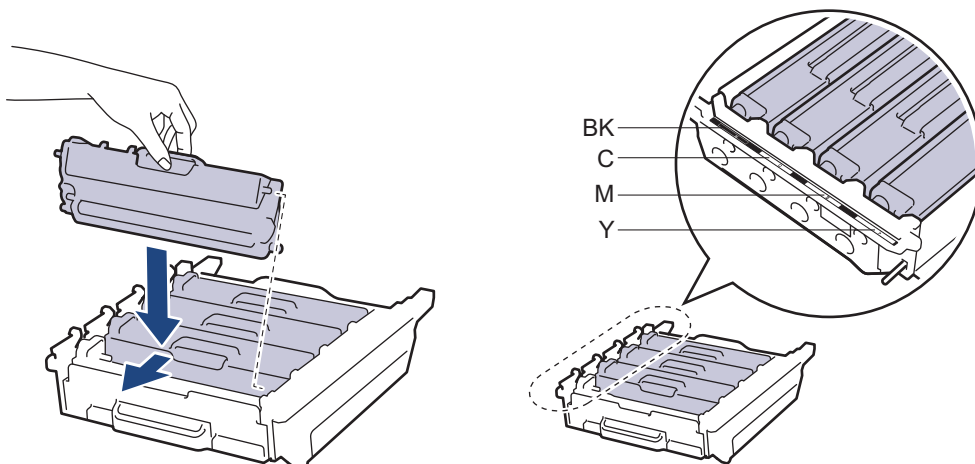

- BK: Black

- C: Cyan
- M: Magenta
- Y: Yellow



Make sure you put the toner cartridge in correctly or it may separate from the drum unit.

15. Make sure the green lock lever (1) is in the release position, as shown in the illustration.

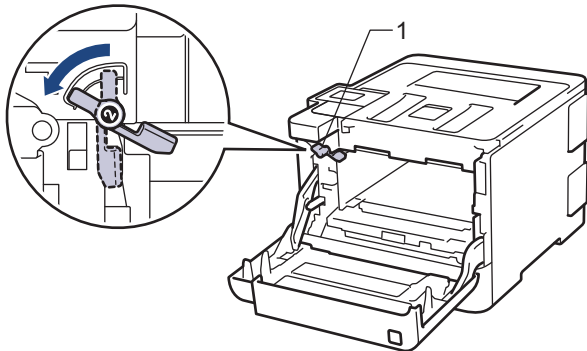

16. Gently slide the drum unit into the machine until it stops at the green lock lever.

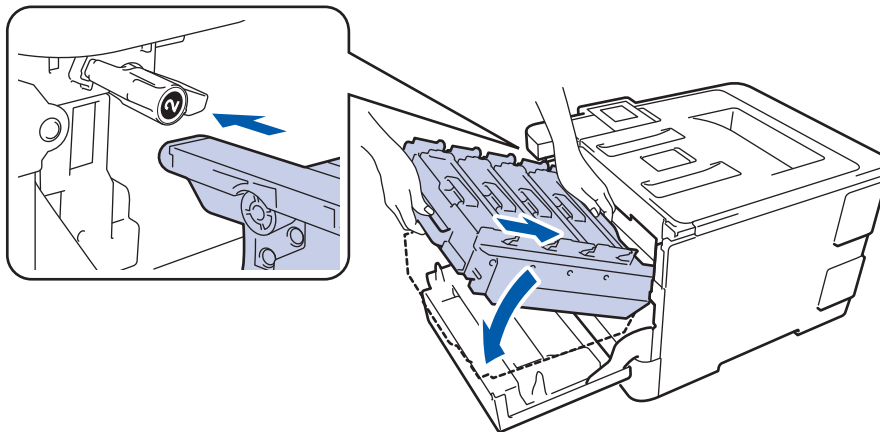

17. Turn the green lock lever clockwise to the lock position.

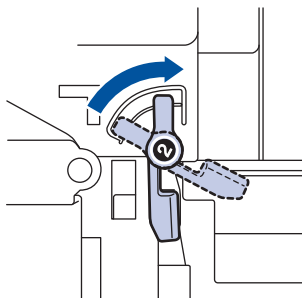

18. Using the green handle, push the drum unit back into the machine until it locks in place.

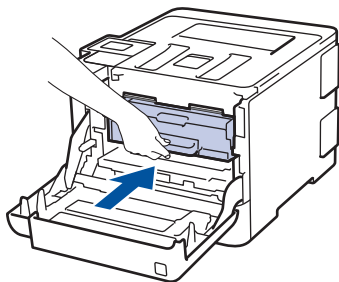

19. Close the machine's front cover.

20. Press  to turn on the machine.



Related Information

- [Clean the Machine](#)

-
- Improve the Print Quality
-

Clean the Paper Pick-up Rollers

Cleaning the paper pick-up rollers periodically may prevent paper jams by ensuring that paper feeds properly.

If you have paper feed problems, clean the pick-up rollers as follows:

1. Press and hold  to turn off the machine.
2. Pull the paper tray completely out of the machine.



3. If paper is loaded or something is stuck inside in the paper tray, remove it.
4. Tightly wring out a lint-free cloth soaked in lukewarm water, and then wipe the separator pad on the paper tray to remove dust.

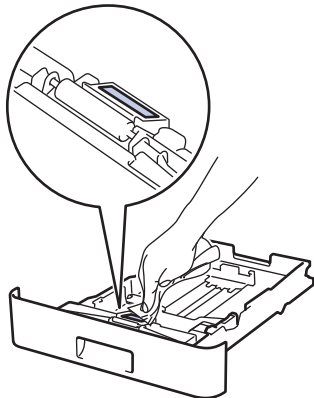

5. Wipe the two pick-up rollers inside the machine to remove dust.

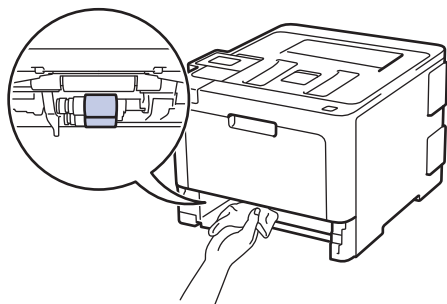

6. Reload the paper and put the paper tray firmly back in the machine.
7. Press  to turn on the machine.

Related Information

- [Clean the Machine](#)
- [Printing Problems](#)

Calibrate Color Output

The output density for each color may vary depending on the machine's environment, including factors like temperature and humidity. Calibrating your machine helps improve the output color density.



If you are using the Macintosh printer driver, the printer driver automatically retrieves the calibration data. To retrieve the data manually, you must perform the calibration using Brother's **Status Monitor**.

1. Press  [Toner] > [Calibration] > [Calibrate].
2. Press [Yes].



Calibration starts automatically, and will take a few minutes.

3. Press .





Related Information

- [Routine Maintenance](#)
- [Reset the Machine's Calibration Settings](#)
- [Improve the Print Quality](#)
- [Monitor the Status of the Machine from Your Computer \(Windows®\)](#)
- [Monitor the Status of the Machine from Your Computer \(Macintosh\)](#)

Reset the Machine's Calibration Settings

If the output color differs from what you see on your monitor, try resetting your machine's calibration parameters.

1. Press  [Toner] > [Calibration] > [Reset].
2. Press [Yes].
3. Press .



Related Information

- [Calibrate Color Output](#)
-

Correct Color Print Alignment (Color Registration)

If solid areas of color or images have cyan, magenta or yellow fringes, use the Color Registration function.

1. Press  [Toner] > [Registration].
2. Press [Yes].



Color registration starts automatically, and will take around 10 seconds or more.



3. Press .



Related Information

- [Routine Maintenance](#)

Check the Remaining Part Life

1. Press  [Settings] > [All Settings] > [Machine Information] > [Parts Life].
2. Press ▲ or ▼ to display the machine parts, and then press the machine part you want to check.
The LCD displays the approximate remaining part life.
3. Press .



To display the approximate remaining life of toner cartridges, press  [Toner] > [Toner Life] .



Related Information

- [Routine Maintenance](#)

Pack and Ship Your Brother Machine

WARNING

- To prevent possible injuries, at least two people should lift the product by holding it at the front and back.
- When you move the machine, carry the machine as shown in the illustration below.

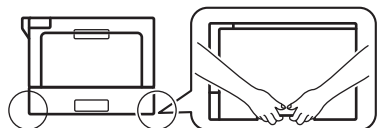

- If the machine has the Optional Tray(s) installed, remove the Optional Tray(s) BEFORE moving the machine. Attempting to move the machine without removing the Optional Tray(s) may cause injury to you or damage to the machine.
- Pack the Optional Tray(s) separately in its original carton with original packing material.



- If for any reason you must ship your machine, carefully repack the machine in the original packaging to avoid any damage during transit. The machine should be adequately insured with the carrier.
- Unless you are returning the machine as part of the Brother Exchange Service, leave the toner cartridge and drum unit inside the machine when you pack and ship it.

1. Press and hold  to turn off the machine. Leave the machine off for at least 10 minutes to cool down.
2. Disconnect all the cables, and then unplug the power cord from the AC power outlet.
3. Put the machine into the bag it originally came in.
4. Pack the machine, the printed materials, and the AC power cord (if applicable) in the original carton with the original packing material as shown. If you are returning your machine to Brother as part of the Exchange Service, pack only the machine. Keep all separate parts and printed materials to use with your "Exchange" machine.

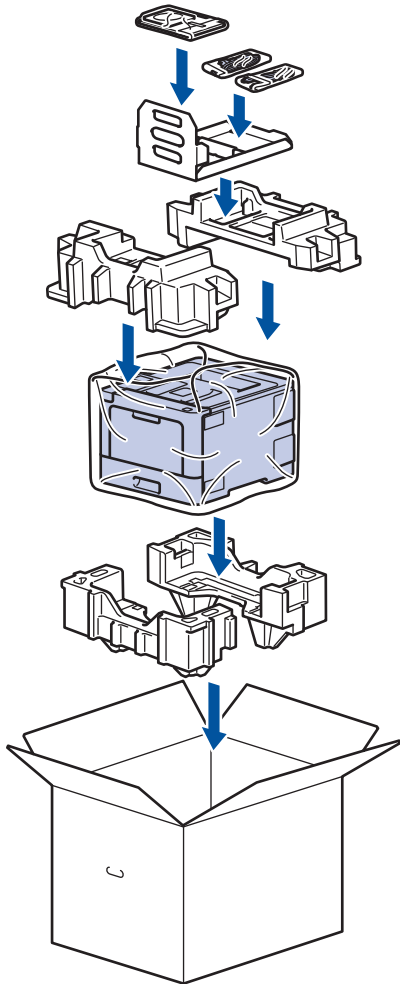

5. Close the carton and tape it shut.
6. If you have a Lower Tray, repack it as shown.

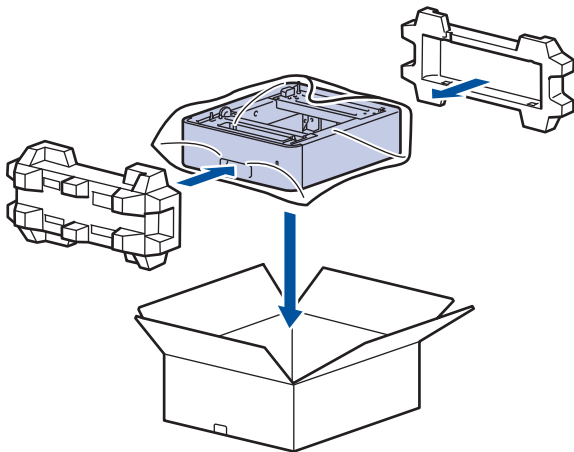

Related Information

- [Routine Maintenance](#)

Replace Periodic Maintenance Parts

Replace the following parts regularly to maintain print quality. The parts listed below must be replaced after printing approximately 50,000 pages¹ for the PF Kit MP and 100,000 pages¹ for the other parts.

Contact Brother Customer Service or a Brother Authorized Service Center when the following message appears on the LCD:

LCD Message	Description
Replace Fuser ²	Replace the Fuser Unit.
Replace Laser ²	Replace the Laser Unit.
Replace PF Kit 1 ²	Replace the Paper Feeding Kit for the Paper Tray.
Replace PF Kit 2 ^{2 3}	Replace the Paper Feeding Kit for the Optional Tray(s).
Replace PF Kit MP ²	Replace the Paper Feeding Kit for the Multi-purpose Tray.



Related Information

- [Routine Maintenance](#)

¹ Letter or A4 size 1-sided pages

² Replacement frequency depends on the complexity of printed pages, percentage of coverage, and the type of media used.

³ If you use the Optional Tray(s) with your machine, this message will appear on the LCD. When the machine has multiple Optional Trays, the machine displays messages using numbers corresponding to each Optional Tray.

Machine Settings

Customize settings and features, create shortcuts, and work with options displayed on the machine's LCD to make your Brother machine a more efficient work tool.

- [Change Machine Settings from the Control Panel](#)
- [Change Machine Settings from Your Computer](#)

Change Machine Settings from the Control Panel

- [General Settings](#)
- [Settings and Features Tables](#)



General Settings

- [Set Sleep Mode Countdown](#)
- [About Deep Sleep Mode](#)
- [Set Auto Power Off Mode](#)
- [Adjust the LCD Backlight Brightness](#)
- [Change How Long the LCD Backlight Stays On](#)
- [Reduce Toner Consumption](#)
- [Reduce Printing Noise](#)
- [Change the Language on the LCD](#)

Set Sleep Mode Countdown

The Sleep Mode (or Power Save Mode) setting can reduce power consumption. Select how long the machine must be idle before it goes into Sleep Mode. The Sleep Mode timer is reset when the machine receives a print job.

When the machine is in Sleep Mode, it acts as if it is turned off. The machine will wake up and start printing when it receives a print job. Use these instructions to set a time delay (countdown) before the machine enters Sleep Mode.

1. Press  [Settings] > [All Settings] > [General Setup] > [Ecology] > [Sleep Time].
2. Enter the length of time (maximum 50 minutes) the machine will remain idle before entering Sleep Mode, and then press [OK].
3. Press .



Related Information

- [General Settings](#)

About Deep Sleep Mode

If the machine is in Sleep Mode and does not receive any jobs for certain length of time, the machine will automatically enter Deep Sleep Mode. The length of time is based on your specific model and settings.

Deep Sleep Mode uses less power than Sleep Mode.

Applicable Models	Machine's LCD in Deep Sleep Mode	Conditions That Will Wake the Machine
HL-L9310CDW	The LCD backlight turns off and the Power LED brightens and dims.	<ul style="list-style-type: none">The machine receives a job.Someone presses ,  or the Touchscreen LCD.





Related Information

- [General Settings](#)

Set Auto Power Off Mode

If the machine is in Deep Sleep Mode for certain length of time, based on your model and settings, the machine will go into Power Off Mode automatically. The machine does not go into Power Off Mode when the machine is connected to a network or has secure print data in the memory.

- To start printing, press  on the control panel and then send a print job.

1. Press  [Settings] > [All Settings] > [General Setup] > [Ecology] > [Auto Power Off].
2. Press ▲ or ▼ to display the length of time the machine will remain idle before entering Power Off Mode, and then press the option you want.
3. Press .





Related Information

- [General Settings](#)

Adjust the LCD Backlight Brightness

If you are having difficulty reading the LCD, changing the brightness setting may help.

1. Press  [Settings] > [All Settings] > [General Setup] > [LCD Settings] > [Backlight].
2. Press the option you want.
 - [Light]
 - [Med]
 - [Dark]
3. Press .





Related Information

- [General Settings](#)

Change How Long the LCD Backlight Stays On

Set how long the LCD backlight stays on.

1. Press  [Settings] > [All Settings] > [General Setup] > [LCD Settings] > [Dim Timer].
2. Press the option you want.
 - [10Secs]
 - [30Secs]
 - [1Min]
 - [2Mins]
 - [3Mins]
 - [5Mins]
3. Press .





Related Information

- [General Settings](#)

Reduce Toner Consumption

Using the Toner Save feature may reduce toner consumption. When Toner Save is set to on, the print on your documents appears lighter.

We DO NOT recommend using the Toner Save feature for printing photo or grayscale images.

1. Press  [Settings] > [All Settings] > [General Setup] > [Ecology] > [Toner Save].
2. Press [On] or [Off].
3. Press .





Related Information

- [General Settings](#)
- [Improve the Print Quality](#)

Reduce Printing Noise

The Quiet Mode setting can reduce printing noise. When Quiet Mode is turned on, the print speed becomes slower. The factory setting is off.

1. Press  [Settings] > [All Settings] > [General Setup] > [Ecology] > [Quiet Mode].
2. Press [On] or [Off].
3. Press .





Related Information

- [General Settings](#)

Change the Language on the LCD

Change the LCD language if needed.

This feature is not available in some countries.

1. Press  [Settings] > [All Settings] > [Initial Setup] > [Local Language].
2. Press your language.
3. Press .

Related Information

- [General Settings](#)
-

Settings and Features Tables

The Settings tables will help you understand the menu selections and options that are found in the machine's programs.

- [Settings Tables \(HL-L9310CDW\)](#)
- [Feature Tables \(HL-L9310CDW\)](#)

Settings Tables (HL-L9310CDW)



[Settings]

Level 2	Level 3	Level 4	Descriptions
Toner	Toner Life	-	View the approximate remaining toner life.
	Test Print	-	Print a test page.
	Calibration	Calibrate	Initiate color calibration to check and correct colors.
		Reset	Reset the calibration parameters to the default settings.
	Registration	-	Align the print position of each color.
Network	-	-	Access the Network setting menus.
Tray Setting	-	-	Access the tray setting menus.
Wi-Fi Direct	-	-	Access the Wi-Fi Direct setting menus.
All Settings	-	-	Configure the detailed settings.

[All Settings] > [General Setup]

Level 3	Level 4	Level 5	Descriptions
Tray Setting	Paper Type	MP Tray	Select the paper type that matches the paper in the MP tray.
		Tray 1	Select the paper type that matches the paper in the standard paper tray.
		Tray 2 1	Select the paper type that matches the paper in the Optional Tray (Tray 2).
		Tray 3 2	Select the paper type that matches the paper in the Optional Tray (Tray 3).
		Tray 4 2	Select the paper type that matches the paper in the Optional Tray (Tray 4).
	Paper Size	MP Tray	Select the size of paper you loaded in the MP tray.
		Tray 1	Select the size of paper you loaded in the standard paper tray.
		Tray 2 1	Select the size of paper you loaded in the Optional Tray (Tray 2).
		Tray 3 2	Select the size of paper you loaded in the Optional Tray (Tray 3).
		Tray 4 2	Select the size of paper you loaded in the Optional Tray (Tray 4).
	Paper Low Notice	Paper Low Notice	Select whether to display a message telling you that the paper tray is nearly empty.
		Notice Level	Select the minimum paper level that will trigger the message.
	Check Size	-	Select whether to display a message telling you to check that the size of the paper in the machine and the machine's Paper Size setting match.
	Tray Use	-	Select the tray that will be used.
Priority	-	When the Auto option is selected in the Tray Use menu, select the order in which the machine uses paper trays that contain paper of the same size.	

Level 3	Level 4	Level 5	Descriptions
LCD Settings	Backlight	-	Adjust the brightness of the LCD backlight.
	Dim Timer	-	Set how long the LCD backlight stays on after the last finger press.
Ecology	Toner Save	-	Increase the page yield of the toner cartridge.
	Sleep Time	-	Set how much time will pass before the machine enters Power Saving Mode.
	Quiet Mode	-	Decrease printing noise.
	Auto Power Off	-	Set the number of hours that the machine will remain in Deep Sleep Mode before going into Power Off Mode.
Setting Lock	Set Password	-	Restrict unauthorized users from changing the machine's settings.
	Lock Off⇒On	-	
	New Password: (Available only when you enter the password for the first time.)	-	
Interface	Select	-	Select the interface to use. If you select the <code>Auto</code> option, the machine changes the interface to USB or Network depending on which interface is receiving data.
	Auto IF Time	-	Set the time-out period for the auto interface selection.
	Input Buffer	-	Increase or decrease the input buffer capacity.

1 (HL-L9310CDW) Available if the Optional Tray(s) is installed.

2 Available if the Optional Tray(s) is installed.

[All Settings] > [Printer]

Level 3	Level 4	Level 5	Descriptions
Emulation	-	-	Choose the emulation mode.
Quality	-	-	Select the print quality.
Print Options	Font List	HP LaserJet	Print the font list and samples of HP LaserJet.
		BR-Script 3	Print the font list and samples of BR-Script.
	Test Print	-	Print the test page.
2-sided	2-sided Print	-	Select whether to print on both sides of the paper.
	Single Image	-	For a print job where the last page is a 1-sided image, select the <code>1-sided Feed</code> option to reduce printing time. When you use letterhead or preprinted paper, you must select the <code>2-sided Feed</code> option. If you select <code>1-sided Feed</code> for letterhead or preprinted paper, the last page will be printed on the reverse side.
Auto Continue	-	-	Select if you want the machine to clear paper size errors or media type errors automatically, and use paper from other trays.
Output Color	-	-	Set the output color.
Paper Type	-	-	Set the type of paper.
Paper Size	-	-	Set the size of paper.
Copies	-	-	Set the number of printed pages.

Level 3	Level 4	Level 5	Descriptions
Orientation	-	-	Set pages to print in either portrait or landscape orientation.
Print Position	X Offset	-	Move the print start position (at the top-left corner of pages) horizontally up to -500 (left) to +500 (right) dots in 300 dpi.
	Y Offset	-	Move the print start position (at the top-left corner of pages) vertically up to -500 (up) to +500 (down) dots in 300 dpi.
Auto FF	-	-	Allow the machine to print any remaining data automatically.
HP LaserJet	Font No.	Font No.	Set the font number.
		Soft Font No.	Set the soft font number. This menu appears if a soft font is installed on your Brother machine.
	Font Pitch	-	Set the font pitch. (Available for certain font numbers)
	Font Point	-	Set the font size. (Available for certain font numbers)
	Symbol Set	-	Select the symbol or character set.
	Table Print	-	Print the code table.
	Auto LF	-	ON: CR -> CR+LF, OFF: CR -> CR
	Auto CR	-	ON: LF -> LF+CR, FF -> FF+CR, or VT -> VT+CR OFF: LF -> LF, FF -> FF, or VT -> VT
	Auto WRAP	-	Choose whether a line feed and carriage return will happen when the machine reaches the right margin.
	Auto SKIP	-	Choose whether a line feed and carriage return will happen when the carriage position reaches the bottom margin.
	Left Margin	-	Set the left margin at column 0 to 70 columns at 1 cpi.
	Right Margin	-	Set the right margin at column 10 to 80 columns at 1 cpi.
	Top Margin	-	Set the top margin distance from the top edge of the paper.
	Bottom Margin	-	Set the bottom margin distance from the bottom edge of the paper.
		Lines	-
	Tray Command	-	Select this setting if a tray mismatch appears when you use the HP drivers.
BR-Script 3	Error Print	-	Choose whether the machine prints the error information when errors occur.
	CAPT	-	Use CAPT (Color Advanced Printing Technology) for optimal print quality when printing a PS file created by a non-Brother PS driver. Colors and photos appear clearer and more accurate. Print speed will be slower.
Color Correction	Calibration	Calibrate	Initiate color calibration to check and correct colors.
		Reset	Reset the calibration parameters to the default settings.

Level 3	Level 4	Level 5	Descriptions	
Color Correction	Registration	-	Align the print position of each color.	
	Auto Correction	-	Set the machine to perform Color Calibration and Registration automatically.	
	Color Settings	Setting Mode		Select whether to apply the color print settings of the machine or the printer driver.
		Color Mode		Select the color mode.
		Improve Gray Color		Turn on or off to improve the image quality of shaded areas.
		Enhance Black Printing		Turn on or off if a black graphic does not print correctly.
		Brightness		Adjust the brightness.
		Contrast		Adjust the contrast.
		Red		Adjust the red color.
		Green		Adjust the green color.
		Blue		Adjust the blue color.

[All Settings] > [Network]

Level 3	Level 4	Level 5	Level 6	Descriptions	
Wired LAN	TCP/IP	Boot Method	-	Choose the IP method that best suits your needs.	
		IP Address	-	Enter the IP address.	
		Subnet Mask	-	Enter the Subnet mask.	
		Gateway	-	Enter the Gateway address.	
		Node Name	-	Enter the Node name.	
		WINS Configuration	-	Select the WINS configuration mode.	
		WINS Server	Primary		Specify the IP address of the primary WINS server.
			Secondary		Specify the IP address of the secondary WINS server.
		DNS Server	Primary		Specify the primary DNS server's IP address.
			Secondary		Specify the secondary DNS server's IP address.
		IP Boot Tries	-		Specify the number of attempts the machine will try to obtain an IP address when the <i>Boot Method</i> is set to any setting except <i>Static</i> .
		APIPA	-		Allocate the IP address from the link-local address range automatically ¹ .
		IPv6	-		Enable or disable the IPv6 protocol.
	Ethernet	-	-	Choose the Ethernet link mode.	
	Wired Status	-	-	Display the Ethernet link status.	
	MAC Address	-	-	Display the MAC address of the machine.	
	Set to Default	-	-	Restore wired network settings of your machine to the factory settings.	

Level 3	Level 4	Level 5	Level 6	Descriptions
Wired LAN	Wired Enable	-	-	Turn the wired interface on or off.
WLAN	TCP/IP	Boot Method	-	Choose the IP method that best suits your needs.
		IP Address	-	Enter the IP address.
		Subnet Mask	-	Enter the Subnet mask.
		Gateway	-	Enter the Gateway address.
		Node Name	-	Enter the Node name.
		WINS Configuration	-	Select the WINS configuration mode.
		WINS Server	Primary	Specify the IP address of the primary WINS server.
			Secondary	Specify the IP address of the secondary WINS server.
		DNS Server	Primary	Specify the primary DNS server's IP address.
			Secondary	Specify the secondary DNS server's IP address.
		IP Boot Tries	-	Specify the number of attempts the machine will try to obtain an IP address when the <code>Boot Method</code> is set to any setting except <code>Static</code> .
		APIPA	-	Allocate the IP address from the link-local address range automatically ¹ .
		IPv6	-	Enable or disable the IPv6 protocol.
	Setup Wizard	-	-	Configure the wireless network settings using the setup wizard.
	WLAN Assistant	-	-	Configure your wireless network settings using the Brother installation disc.
	WPS	-	-	Configure your wireless network settings using the one-button push method.
	WPS w/ PIN Code	-	-	Configure the wireless network settings using WPS with a PIN code.
	WLAN Status	Status	-	Display the wireless Ethernet link status.
		Signal	-	Display the signal condition.
		SSID	-	Display SSID.
Comm. Mode		-	Display the current Communication Mode.	
MAC Address	-	-	Display the MAC address of the machine.	
Set to Default	-	-	Restore wireless network settings of your machine to the factory settings.	
WLAN Enable	-	-	Turn the wireless interface on or off.	
Wi-Fi Direct	Push Button	-	-	Configure your Wi-Fi Direct network settings using the one-button push method quickly.

Level 3	Level 4	Level 5	Level 6	Descriptions	
Wi-Fi Direct	PIN Code	-	-	Configure your Wi-Fi Direct network settings using WPS with a PIN code quickly.	
	Manual	-	-	Configure your Wi-Fi Direct network settings manually.	
	Group Owner	-	-	Set your machine as the Group Owner.	
	Device Information	Device Name	-	-	View your machine's device name.
		SSID	-	-	Display the Group Owner's SSID.
		IP Address	-	-	Display your machine's IP Address.
	Status Information	Status	-	-	Display the Wi-Fi Direct network status.
Signal		-	-	Display the current Wi-Fi Direct network signal strength.	
I/F Enable	-	-	-	Enable or disable the Wi-Fi Direct connection.	
NFC	-	-	-	Turn the NFC function on or off.	
Web Connect Settings	Proxy Settings	Proxy Connection	-	Change the web connection settings.	
		Address	-		
		Port	-		
		User Name	-		
		Password	-		
IPsec	-	-	-	IPsec is an optional security feature of the IP protocol that provides authentication and encryption services. We recommend contacting your network administrator before changing this setting.	
Network Reset	-	-	-	Restore all network settings of your machine to the factory settings.	

¹ On connection to the network, if the machine's 'Boot Method' is 'Auto' the machine will attempt to set the IP address and Subnet Mask from a boot server such as DHCP. If a boot server cannot be found, an APIPA IP address will be allocated, such as 169. 254. [001-254]. [000-255]. If the 'Boot Method' of the machine is set to 'Static' you must manually enter an IP address from the machine's control panel.

[All Settings] > [Print Reports]

Level 3	Descriptions
Printer Settings	Print the Printer Settings page.
Network Configuration	Print the Network Configuration Report.
Print File List	Print a list of data saved in the memory.
WLAN Report	Print the wireless LAN connectivity diagnosis result.
Drum Dot Print	Print the Drum Dot Check Sheet.

[All Settings] > [Machine Information]

Level 3	Level 4	Descriptions
Serial No.	-	Display the machine's serial number.
Firmware Version	Main Version	Display the main firmware version.
	Sub1 Version	Display the sub firmware version.
Page Counter	Total	Display the total printed pages.

Level 3	Level 4	Descriptions
Page Counter	Color	Display the total color printed pages.
	Black and White	Display the total monochrome printed pages.
Parts Life ¹	Drum	Display the remaining life of the drum unit.
	Belt	Display the remaining life of the belt unit.
	Fuser	Display the remaining life of the fuser unit.
	Laser	Display the remaining life of the laser unit.
	PF Kit MP	Display the remaining life of the PF kit MP.
	PF Kit 1	Display the remaining life of the PF Kit 1.
	PF Kit 2 ²	Display the remaining life of the PF Kit 2.
	PF Kit 3 ³	Display the remaining life of the PF Kit 3.
PF Kit 4 ³	Display the remaining life of the PF Kit 4.	

¹ Life is approximate and may vary by type of use.

² (HL-L9310CDW) Available if the Optional Tray(s) is installed.

³ Available if the Optional Tray(s) is installed.

[All Settings] > [Initial Setup]

Level 3	Level 4	Descriptions
Reset	Machine Reset	Restore all the machine's settings that you have changed, such as Paper Type.
	Network Reset	Restore all network settings of your machine to the factory settings.
	Factory Reset	Reset the machine and restore the printer settings (including command settings) to the factory settings.
Local Language	-	Select the LCD language for your country.



Related Information

- [Settings and Features Tables](#)

Feature Tables (HL-L9310CDW)

(Toner)

Level 2	Level 3	Level 4	Descriptions
 (Toner)	Toner Life	-	View the approximate remaining toner life for each color.
	Test Print	-	Print the test page.
	Calibration	Calibrate	Initiate color calibration to check and correct colors.
		Reset	Reset the calibration parameters to the default settings.
Registration	-	Align the print position of each color.	

(Wi-Fi Setup)

Level 2	Level 3	Descriptions
 (Wi-Fi Setup)	TCP/IP 1	Change the TCP/IP settings.
	Setup Wizard	Configure the wireless network settings using the setup wizard.
	WLAN Assistant	Configure your wireless network settings using the Brother installation disc.
	WPS	Configure your wireless network settings using the one-button push method.
	WPS w/ PIN Code 1	Configure the wireless network settings using WPS with a PIN code.
	WLAN Status 1	Display the wireless network connection status.
	MAC Address 1	Display the MAC address of the machine.
	Set to Default 1	Restore wireless network settings of your machine to the factory settings.
WLAN Enable 1	Turn the wireless interface on or off.	

¹ (Available after the Wi-Fi® is set up)

[Web]

Level 3	Descriptions
Web	Connect the Brother machine to an Internet service. Web services may have been added and service names may have been changed by the provider since this document was published.

[Direct Print]

Level 3	Level 4	Level 5	Level 6	Descriptions
Direct Print	(Select the file you want to print out.)	Print Settings	Paper Type	Set the print media type when printing directly from a USB flash drive.

Level 3	Level 4	Level 5	Level 6	Descriptions	
Direct Print	(Select the file you want to print out.)	Print Settings	Paper Size	Set the paper size when printing directly from a USB flash drive.	
			Multiple Page	Set the page layout when printing multiple pages directly from a USB flash drive.	
			Orientation	Select the page orientation when printing directly from a USB flash drive.	
			2-sided	Select whether to print on both sides of the paper when printing directly from a USB flash drive.	
			Collate	Enable or disable page collation when printing directly from a USB flash drive.	
			Tray Use	Select the paper tray that will be used when printing directly from a USB flash drive.	
			Print Quality	Set the print quality option when printing directly from a USB flash drive.	
			PDF Option	Set the USB Direct Print setting to print either comments (Markup) or stamps in the PDF file, along with the text.	
	Color Start	-	Print data in color directly from the USB flash drive.		
	Black Start	-	Print data in black directly from the USB flash drive.		
	Index Print	-	-	Print a thumbnail page.	
	DefaultSettings		Paper Type	-	Set the print media type when printing directly from a USB flash drive.
			Paper Size	-	Set the paper size when printing directly from a USB flash drive.
			Multiple Page	-	Set the page layout when printing multiple pages directly from a USB flash drive.
Orientation			-	Select the page orientation when printing directly from a USB flash drive.	
Collate			-	Enable or disable page collation when printing directly from a USB flash drive.	
Print Quality			-	Set the print quality option when printing directly from a USB flash drive.	
PDF Option			-	Set the USB Direct Print setting to print either comments (Markup) or stamps in the PDF file, along with the text.	
Index Print	-	-	Set the default index print option to simple format or details.		



Related Information

- [Settings and Features Tables](#)
-

Change Machine Settings from Your Computer

- [Change Machine Settings Using Web Based Management](#)
- [Where Can I Find My Brother Machine's Network Settings?](#)
- [Network Management Software and Utilities](#)

Change Machine Settings Using Web Based Management

Web Based Management is a utility that uses a standard web browser to manage your machine using the Hyper Text Transfer Protocol (HTTP) or Hyper Text Transfer Protocol over Secure Socket Layer (HTTPS).

- [What is Web Based Management?](#)
- [Access Web Based Management](#)
- [Set a Login Password for Web Based Management](#)
- [Network Management Software and Utilities](#)

What is Web Based Management?

Web Based Management is a utility that uses a standard web browser to manage your machine using the Hyper Text Transfer Protocol (HTTP) or Hyper Text Transfer Protocol over Secure Socket Layer (HTTPS). Type your machine's IP address into your web browser to access and change your print server settings.



- We recommend Microsoft® Internet Explorer® 11 for Windows® and Safari 9 for Macintosh. Make sure that JavaScript and Cookies are always enabled in whichever browser you use.
- You must use the TCP/IP protocol on your network and have a valid IP address programmed into the print server and your computer.

The screenshot displays the Brother web-based management interface. At the top, there is a header with the IP address 'XXX-XXXX', a password configuration prompt 'Please configure the password >>', and the Brother logo with 'Brother Solutions Center'. Below the header are navigation tabs for 'General', 'Print', 'Administrator', and 'Network'. A left sidebar contains a menu with options like 'Status', 'Auto Refresh Interval', 'Maintenance Information', 'Lists/Reports', 'Find Device', 'Contact & Location', 'Sleep Time', 'Auto Power Off', 'Language', and 'Panel'. The main content area is titled 'Status' and shows the following information:

- Device Status:** Ready (indicated by a green bar)
- Automatic Refresh:** Off (selected radio button) / On
- Toner Level:** Four bars representing BK (Black), C (Cyan), M (Magenta), and Y (Yellow).
- Web Language:** Auto (dropdown menu)
- Device Location:** Fields for Contact (with a person icon) and Location (with a house icon).

- The actual screen may differ from the screen shown above.



Related Information

- [Change Machine Settings Using Web Based Management](#)

Access Web Based Management

- We recommend using the HTTPS security protocol when configuring settings using Web Based Management.
- When you use HTTPS for Web Based Management configuration, your browser will display a warning dialog box.

1. Start your web browser.
2. Type "http://machine's IP address" in your browser's address bar (where "machine's IP address" is the machine's IP address).

For example:

http://192.168.1.2



- If you are using a Domain Name System or enable a NetBIOS name, you can type another name, such as "SharedPrinter" instead of the IP address.

- For example:

http://SharedPrinter

If you enable a NetBIOS name, you can also use the node name.

- For example:

http://brnxxxxxxxxxxxx

The NetBIOS name can be found in the Network Configuration Report.

- For Macintosh, access Web Based Management by clicking the machine's icon on the **Status Monitor** screen.

3. No password is required by default. Type a password if you have set one, and then click .

You can now change the print server settings.

If you change the protocol settings, you must restart the machine after clicking **Submit** to activate the configuration.



Related Information

- [Change Machine Settings Using Web Based Management](#)
- [Print the Network Configuration Report](#)

Set a Login Password for Web Based Management

We recommend setting a login password to prevent unauthorized access to Web Based Management.

1. Start your web browser.
2. Type "http://machine's IP address" in your browser's address bar (where "machine's IP address" is the machine's IP address).

For example:

http://192.168.1.2



- If you are using a Domain Name System or enable a NetBIOS name, you can type another name, such as "SharedPrinter" instead of the IP address.

- For example:

http://SharedPrinter

If you enable a NetBIOS name, you can also use the node name.

- For example:

http://brnxxxxxxxxxxxx

The NetBIOS name can be found in the Network Configuration Report.

- For Macintosh, access Web Based Management by clicking the machine's icon on the **Status Monitor** screen.

3. No password is required by default. Type a password if you have set one, and then click .
4. Click **Administrator**.
5. Type the password you want to use in the **Enter New Password** field (8 to 32 characters).
6. Retype the password in the **Confirm New Password** field.
7. Click **Submit**.

In the future, every time you access Web Based Management, type the password in the **Login** field, and then click .

After configuring the settings, log off by clicking .



If you have not previously set a login password, you can also set a password by clicking the **Please configure the password** button on the machine's web page.



Related Information

- [Change Machine Settings Using Web Based Management](#)

Appendix

- [Specifications](#)
- [How to Enter Text on Your Brother Machine](#)
- [Supplies](#)
- [Important Information About Toner Cartridge Life](#)
- [Accessories](#)
- [Brother Numbers](#)

Specifications

General Specifications

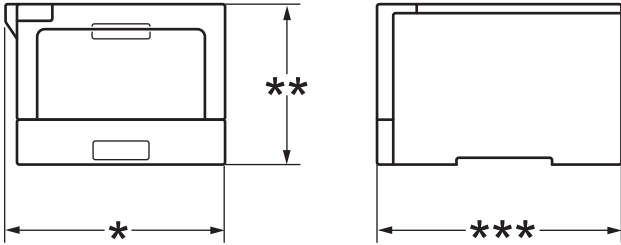
Printer Type		<ul style="list-style-type: none"> Laser
Print Method		<ul style="list-style-type: none"> Electrophotographic Laser Printer
Memory Capacity	Standard	<ul style="list-style-type: none"> 1 GB
LCD (Liquid Crystal Display)		<ul style="list-style-type: none"> 2.7 in. (67.5 mm) TFT Color Touchscreen LCD ¹
Power Source		<ul style="list-style-type: none"> 110 to 120 V AC 50/60 Hz
Power Consumption (Average)	Peak	<ul style="list-style-type: none"> Approximately 1190 W
	Printing ²	<ul style="list-style-type: none"> Approximately 600 W at 77 °F (25 °C)
	Printing (Quiet Mode) ²	<ul style="list-style-type: none"> Approximately 350 W at 77 °F (25 °C)
	Ready ²	<ul style="list-style-type: none"> Approximately 75 W at 77 °F (25 °C)
	Sleep ²	<ul style="list-style-type: none"> Approximately 9.5 W
	Deep Sleep ²	<ul style="list-style-type: none"> (HL-L9310CDW) Approximately 1.4 W
	Power Off ^{3 4}	<ul style="list-style-type: none"> Approximately 0.02 W
Dimensions (Typical outline view)		Unit: in. (mm) <ul style="list-style-type: none"> * : 17.4 (441) ** : 12.3 (313) *** : 19.1 (486)
		
Weights (with supplies)		<ul style="list-style-type: none"> 48.9 lb (22.2 kg)

¹ Measured diagonally

² Measured when the machine is connected to the USB interface.

³ Measured according to IEC 62301 Edition 2.0.

⁴ Power consumption varies slightly depending on the usage environment.

Noise Level	Sound Pressure	Printing	• LpAm = 49 dB (A)	
		Printing (Quiet Mode)	• LpAm = 44 dB (A)	
		Ready	• LpAm = Inaudible	
	Sound Power	Printing	Monochrome	• LWAd = 6.55 B (A)
			Color	• LWAd = 6.56 B (A)
		Printing (Quiet Mode)	Monochrome	• LWAd = 6.00 B (A)
			Color	• LWAd = 6.00 B (A)
Ready	• LWAd = Inaudible			
Temperature	Operating	• 50 to 90 °F (10 to 32 °C)		
	Storage	• 32 to 104 °F (0 to 40 °C)		
Humidity	Operating	• 20 to 80% (without condensation)		
	Storage	• 10 to 90% (without condensation)		

Print Media Specifications

Paper Input	Paper Tray (Standard)	Paper Type	• Plain Paper, Letterhead, Colored Paper, Thin Paper, Recycled Paper
		Paper Size	• A4, Letter, A5, A5(Long Edge), A6, Executive, Legal, Folio, Mexico Legal
		Paper Weight	• 16 to 28 lb (60 to 105 g/m ²)
		Maximum Paper Capacity	• Up to 250 sheets of 20 lb (80 g/m ²) Plain Paper
	Multi-Purpose Tray (MP tray)	Paper Type	• Plain Paper, Letterhead, Colored Paper, Thin Paper, Thick Paper, Thicker Paper, Recycled Paper, Bond, Label, Envelope, Env. Thin, Env.Thick, Glossy Paper
		Paper Size	• Width: 3 to 8.5 in. (76.2 to 215.9 mm) • Length: 5 to 14 in. (127 to 355.6 mm) • Envelope: COM-10, DL, C5, Monarch
		Paper Weight	• 16 to 43 lb (60 to 163 g/m ²)
		Maximum Paper Capacity	• Up to 50 sheets of 20 lb (80 g/m ²) Plain Paper • Envelope: 10 envelopes up to 0.4 in. (10 mm) thick
	Paper Tray 2, 3, 4 (Optional)¹	Paper Type	• Plain Paper, Letterhead, Colored Paper, Thin Paper, Recycled Paper
		Paper Size	• A4, Letter, A5, Executive, Legal, Folio, Mexico Legal
		Paper Weight	• 16 to 28 lb (60 to 105 g/m ²)
		Maximum Paper Capacity	• LT-330CL Up to 250 sheets of 20 lb (80 g/m ²) Plain Paper • LT-340CL

Paper Input	Paper Tray 2, 3, 4 (Optional) ¹		Up to 500 sheets of 20 lb (80 g/m ²) Plain Paper
Paper Output ²	Face Down Output Tray		<ul style="list-style-type: none"> Up to 150 Sheets of 20 lb (80 g/m²) Plain Paper (face down delivery to the face down output paper tray)
	Face Up Output Tray		<ul style="list-style-type: none"> One sheet (face up delivery to the face up output tray)
2-sided	Automatic 2-sided Printing	Paper Type	<ul style="list-style-type: none"> Plain Paper, Letterhead, Colored Paper, Thin Paper, Recycled Paper, Glossy Paper
		Paper Size	<ul style="list-style-type: none"> Letter, Legal, Folio, Mexico Legal
		Paper Weight	<ul style="list-style-type: none"> 16 to 28 lb (60 to 105 g/m²)

¹ Maximum number of Lower Trays: Up to three LT-330CL Lower Trays or up to two Lower Trays in any other combinations

² For labels, we recommend removing the printed sheets from the output paper tray immediately after they exit the machine to avoid the possibility of smudging.

Printer Specifications

Automatic 2-sided Print	<ul style="list-style-type: none"> Yes 		
Emulation	<ul style="list-style-type: none"> PCL6, BR-Script3, PDF Version 1.7, XPS Version 1.0 		
Resolution	<ul style="list-style-type: none"> 600 x 600 dpi, 2,400 dpi class (2400 x 600) quality 		
Print Speed ^{5 6}	1-sided print	Monochrome	<ul style="list-style-type: none"> Up to 33 pages/minute (Letter size) Up to 31 pages/minute (A4 size)
		Color	<ul style="list-style-type: none"> Up to 33 pages/minute (Letter size) Up to 31 pages/minute (A4 size)
	2-sided Print	Monochrome	<ul style="list-style-type: none"> Up to 14 sides/minute (Up to 7 sheets/minute) (Letter or A4 size)
		Color	<ul style="list-style-type: none"> Up to 14 sides/minute (Up to 7 sheets/minute) (Letter or A4 size)
First Print Time ⁷	Monochrome		<ul style="list-style-type: none"> Less than 15 seconds at 73.4 °F (23 °C) / 115 V
	Color		<ul style="list-style-type: none"> Less than 15 seconds at 73.4 °F (23 °C) / 115 V

Interface Specifications

USB ^{1 2}	<ul style="list-style-type: none"> Hi-Speed USB 2.0 Use a USB 2.0 interface cable that is no more than 6 feet (2.0 meters) long.
LAN	<ul style="list-style-type: none"> 10Base-T/100Base-TX/1000Base-T^{3 4}
Wireless LAN	<ul style="list-style-type: none"> IEEE 802.11b/g/n (Infrastructure Mode) IEEE 802.11g/n (Wi-Fi Direct[®])
NFC ⁵	<ul style="list-style-type: none"> Yes

¹ Your machine has a USB 2.0 Hi-Speed interface. The machine can also be connected to a computer that has a USB 1.1 interface.

² Third party USB ports are not supported.

⁵ The print speed may change depending on the type of document you print.

⁶ Print speed may be slower when the machine is connected by wireless LAN.

⁷ From Ready mode and standard tray

- 3 Use a straight-through Category 5e (or greater) twisted-pair cable.
- 4 When you connect the machine to a Gigabit Ethernet Network, use network devices complying with the 1000BASE-T specification.
- 5 When you connect an external IC card reader, use a HID class driver supported device.

Direct Print Feature Specifications

Compatibility	• PDF version 1.7, JPEG, Exif+JPEG, PRN (created by own printer driver), TIFF (scanned by Brother models), XPS version 1.0
Interface	• USB direct interface : Front x 1, Rear x 1

Supported Protocols and Security Features

Ethernet

10Base-T/100Base-TX/1000Base-T

Wireless LAN

IEEE 802.11b/g/n (Infrastructure Mode), IEEE 802.11g/n (Wi-Fi Direct)

Protocols (IPv4)

ARP, RARP, BOOTP, DHCP, APIPA (Auto IP), WINS/NetBIOS name resolution, DNS Resolver, mDNS, LLMNR responder, LPR/LPD, Custom Raw Port/Port9100, IPP/IPPS, FTP Server, TELNET Server, HTTP/HTTPS server, TFTP client and server, SMTP Client, SNMPv1/v2c/v3, ICMP, Web Services (Print), CIFS client, SNTTP client, LDAP

Protocols (IPv6)

NDP, RA, DNS resolver, mDNS, LLMNR responder, LPR/LPD, Custom Raw Port/Port9100, IPP/IPPS, FTP Server, TELNET Server, HTTP/HTTPS server, TFTP client and server, SMTP Client, SNMPv1/v2c/v3, ICMPv6, Web Services (Print), CIFS Client, SNTTP Client, LDAP

Network Security (Wired)

SMTP-AUTH, SSL/TLS (IPPS, HTTPS, SMTP), SNMP v3, 802.1x (EAP-MD5, EAP-FAST, PEAP, EAP-TLS, EAP-TTLS), Kerberos, IPsec

Network Security (Wireless)

SMTP-AUTH, SSL/TLS (IPPS, HTTPS, SMTP), SNMP v3, 802.1x (LEAP, EAP-FAST, PEAP, EAP-TLS, EAP-TTLS), Kerberos, IPsec

Wireless Network Security

WEP 64/128 bit, WPA-PSK (TKIP/AES), WPA2-PSK (TKIP/AES)⁸

Wireless Certification

Wi-Fi Certification Mark License (WPA™/WPA2™ - Enterprise, Personal), Wi-Fi Protected Setup (WPS) Identifier Mark License, Wi-Fi CERTIFIED™ Wi-Fi Direct

Computer Requirements Specifications

Supported Operating Systems And Software Functions

Computer Platform & Operating System Version	PC Interface				Processor	Hard Disk Space to Install
	Parallel (IEEE1284)	USB ¹	10Base-T/100Base-TX/1000Base-T (Ethernet)	Wireless 802.11b/g/n		

⁸ Wi-Fi Direct supports WPA2-PSK (AES) only.

Windows® Operating System	Windows® 7 / 8 / 8.1	N/A	Printing	32 bit (x86) or 64 bit (x64) processor	80 MB
	Windows® 10 Home / 10 Pro / 10 Education / 10 Enterprise				
	Windows Server® 2008		Printing		
	Windows Server® 2008 R2			64 bit (x64) processor	
	Windows Server® 2012				
	Windows Server® 2012 R2				
	Windows Server® 2016				
Macintosh Operating System	macOS v10.10.5		Printing	Intel® Processor	80 MB
	macOS v10.11.x				
	macOS v10.12				

¹ Third party USB ports are not supported.

For the latest driver updates, go to your model's **Downloads** page on the Brother Solutions Center at support.brother.com.

All trademarks, brand and product names are the property of their respective companies.





Related Information

- [Appendix](#)

How to Enter Text on Your Brother Machine

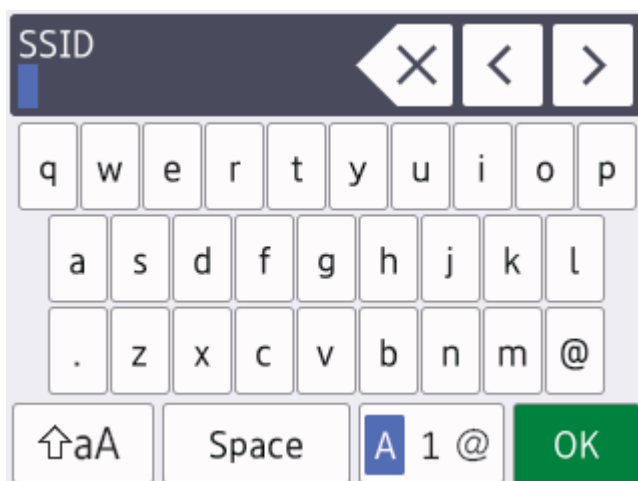
- When you must enter text on your Brother machine, a keyboard appears on the LCD.
- The characters that are available may differ depending on your country.
- The keyboard layout may differ depending on the operation you perform.





- Press  to cycle between letters, numbers and special characters.
- Press  to cycle between lowercase and uppercase letters.
- To move the cursor to the left or right, press ◀ or ▶.

Inserting spaces

- To enter a space, press [Space].

Making corrections

- If you entered a character incorrectly and want to change it, press ◀ or ▶ to move the cursor to the incorrect character and press . Enter the correct character.
- To insert a character, press ◀ or ▶ to move the cursor to the correct place, and then enter the character.
- Press  for each character you want to erase, or press and hold  to erase all the characters.

✓ Related Information

- [Appendix](#)
- [Configure Your Machine for a Wireless Network Using the Machine's Control Panel Setup Wizard](#)
- [Configure Your Machine for a Wireless Network When the SSID Is Not Broadcast](#)

Supplies

When the time comes to replace supplies, such as the toner or drum, an error message will appear on your machine's control panel or in the Status Monitor. For more information about the supplies for your machine, visit www.brother.com/original/index.html or contact your local Brother dealer.

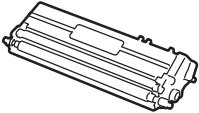
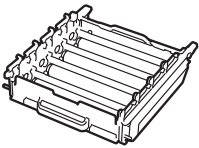
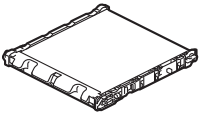
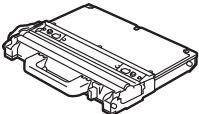

The supply order number will vary depending on your country and region.

Supply Items	Supply order No.	Approximate Life (Page Yield)	Applicable Models
Toner Cartridge 	Super High Yield Toner: <ul style="list-style-type: none"> Black: TN-436BK Cyan: TN-436C Magenta: TN-436M Yellow: TN-436Y 	<ul style="list-style-type: none"> Black: Approximately 6,500 pages^{1 2} Cyan / Magenta / Yellow: Approximately 6,500 pages^{1 2} 	HL-L9310CDW
	Ultra High Yield Toner: <ul style="list-style-type: none"> Black: TN-439BK Cyan: TN-439C Magenta: TN-439M Yellow: TN-439Y 	<ul style="list-style-type: none"> Black: Approximately 9,000 pages^{1 2} Cyan / Magenta / Yellow: Approximately 9,000 pages^{1 2} 	HL-L9310CDW
	Starter Toner: (Supplied with your machine)	<ul style="list-style-type: none"> Black: Approximately 6,500 pages^{1 2} Cyan / Magenta / Yellow: Approximately 6,500 pages^{1 2} 	HL-L9310CDW
Drum Unit 	<ul style="list-style-type: none"> DR-433CL 	<ul style="list-style-type: none"> Approximately 50,000 pages³ 	HL-L9310CDW
Belt Unit 	<ul style="list-style-type: none"> BU-330CL 	<ul style="list-style-type: none"> Approximately 50,000 pages⁴ 	HL-L9310CDW
Waste Toner Box 	<ul style="list-style-type: none"> WT-320CL 	<ul style="list-style-type: none"> Approximately 50,000 pages² 	HL-L9310CDW

-
- 1 Approximate cartridge yield is declared in accordance with ISO/IEC 19798.
 - 2 Letter or A4 size 1-sided pages
 - 3 Approximately 50,000 pages based on 3 pages per job and 30,000 pages based on 1 page per job [A4/Letter simplex pages]. The number of pages may be affected due to a variety of factors including but not limited to media type and media size.
 - 4 Approximately 50,000 pages based on 1 page per job and 130,000 pages based on 3 pages per job [A4/Letter simplex pages]. The number of pages may be affected due to a variety of factors including but not limited to media type and media size.



Related Information

- [Appendix](#)
 - [Replace Supplies](#)
-

Important Information About Toner Cartridge Life

Toner Cartridge Life

This product detects the life of the toner cartridges using the following two methods:

- Detection by counting the dots of each color that are necessary to create an image
- Detection by counting the rotations of the developer roller

This product has a function that will count the dots of each color used to print every document and the rotations of each toner cartridge's developer roller. The print operation will stop when either of the upper limits is reached. The upper limit is set above the number of dots or rotations that would be required for the cartridge to perform consistently with its advertised page yield. This function is intended to reduce the risk of poor print quality and damage to the machine.

There are two messages that indicate when the toner is low or needs replacing: Toner Low and Replace Toner.

Toner Low is displayed on the LCD when the number of dots or rotations of the developer roller nears its maximum count: Replace Toner is displayed on the LCD when the number of dots or rotations of the developer roller reaches its maximum count.

Color Correction

The number of developer roller rotations that are counted may not only be for normal operations, such as printing and copying, but also for machine adjustments, such as Color Calibration and Color Registration.

Color Calibration (Adjustment of Color Density)

To obtain stable print quality, the density of each toner cartridge needs to be maintained at a fixed value. If the density balance between the colors cannot be kept, the tint becomes unstable, and accurate color reproduction becomes unavailable. The toner density can change due to chemical changes to the toner that affect its electrical charge, deterioration of the developer unit, and temperature and humidity levels in the machine. During calibration, the density level adjustment test patterns are printed on the belt unit.

Calibration is mainly performed at the following times:

- When the user manually selects calibration from the operation panel or the printer driver.
(Please perform calibration if color density needs to be improved.)
- When a used toner cartridge is replaced with a new one.
- When the machine detects that the ambient temperature and humidity have changed.
- When a specified number of printed pages is reached.

Color Registration (Correction of Color Position)

In this machine, the drum unit and developer unit are prepared for black (K), yellow (Y), magenta (M), and cyan (C), respectively. Four color images are combined into one image, and therefore color registration errors (for example, how the four color images align) might occur. When registration errors occur, registration correction test patterns are printed on the belt unit.

Registration is mainly performed at the following times:

- When the user manually selects registration from the operation panel.
(Please perform registration if a color registration error needs to be corrected.)
- When a specified number of printed pages is reached.



Related Information

- [Appendix](#)

Accessories

Availability of accessories may vary depending on your country or region. For more information about the accessories for your machine, visit www.brother.com/original/index.html or contact your Brother dealer or Brother Customer Service.

Order No.	Items	Applicable Models
LT-330CL	Lower Tray (250 sheets)	• HL-L9310CDW ¹
LT-340CL	Lower Tray (500 sheets)	• HL-L9310CDW ¹

¹ Maximum number of Lower Trays: Up to three LT-330CL Lower Trays or up to two Lower Trays in any other combinations



Related Information

- [Appendix](#)

Brother Numbers

IMPORTANT

For technical help, you must call the country where you bought the machine. Calls must be made **from within** that country.

FAQs (Frequently Asked Questions)

The Brother Solutions Center is our one-stop resource for all your Machine needs. Download the latest software and utilities and read FAQs and troubleshooting tips to learn how to get the most from your Brother product.

Check here for Brother driver updates, too.

support.brother.com

For Customer Service

In USA:

www.brother-usa.com/support (Self-Service/Email/Chat)

1-877-BROTHER (1-877-276-8437)

In Canada:

www.brother.ca/support

(Self-Service Videos, Email, Chat, Facebook and Twitter Help)

If you have comments or suggestions, write us at:

In USA:

Printer Customer Support

Brother International Corporation

7905 North Brother Boulevard

Bartlett, TN 38133

In Canada:

Brother International Corporation (Canada), Ltd.

Customer Experience Team

1, rue Hotel de Ville Dollard-des-Ormeaux, PQ, Canada H9B 3H6

Service Center Locator (USA only)

For the location of a Brother authorized service center, call 1-877-BROTHER (1-877-276-8437) or visit www.brother-usa.com/service.

Service Center Locations (Canada only)

For the location of a Brother authorized service center, visit www.brother.ca/support.

Ordering Accessories and Supplies

For best quality results use only genuine Brother supplies, which are available at most Brother retailers. If you cannot find the supplies you need and have a Visa, MasterCard, Discover, American Express credit card, or PayPal account, you can order directly from Brother. Visit us online for a complete selection of the Brother accessories and supplies that are available for purchase.

NOTE

In Canada, only Visa and MasterCard are accepted.

In USA:

1-877-552-MALL (1-877-552-6255)

1-800-947-1445 (assistance via fax)

www.brothermall.com

In Canada:

www.brother.ca



Related Information

- [Appendix](#)
-

Brother International Corporation
200 Crossing Boulevard
P.O. Box 6911
Bridgewater, NJ 08807-0911 USA

Brother International Corporation (Canada) Ltd.
1 rue Hôtel de Ville,
Dollard-des-Ormeaux, QC, Canada H9B 3H6

brother

Visit us on the World Wide Web
www.brother.com

This machine is approved for use in the country of purchase only. Local Brother companies or their dealers will support only machines purchased in their own countries.



USA/CAN
Version 0