

**Network Attached Storage**

**TeraStation WSS WS5020N6**

## **User Manual**

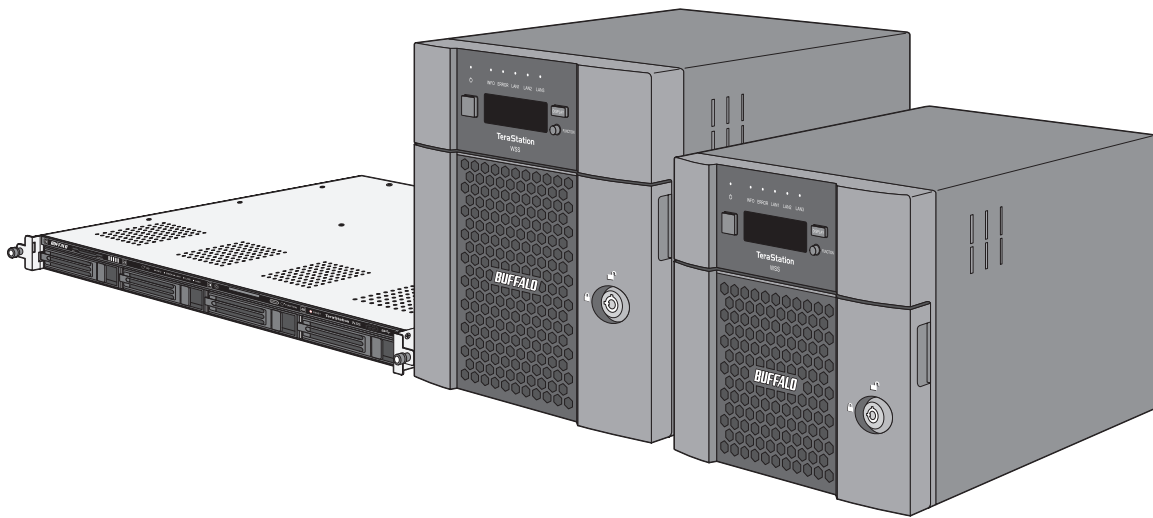

Please make sure to read this manual before using and follow the procedures. If you have any inquiries about the product, contact the number on the warranty statement or the packing box. Do not discard this manual, the warranty statement, or the packing box.

***Americas: [www.buffaloamericas.com](http://www.buffaloamericas.com)***

***Europe: [www.buffalo-technology.com](http://www.buffalo-technology.com)***

***Asia Pacific: [www.buffalo-asia.com](http://www.buffalo-asia.com)***

35021477-01  
April, 2018

# Notice

---

## Regulatory Compliance Information

---

### For Customers in the United States

This equipment has been tested and found to comply with the limits for a Class A digital device, pursuant to Part 15 of the FCC Rules. These limits are designed to provide reasonable protection against harmful interference when the equipment is operated in a commercial environment. This equipment generates, uses, and can radiate radio frequency energy and, if not installed and used in accordance with the instruction manual, may cause harmful interference to radio communications. Operation of this equipment in a residential area is likely to cause harmful interference in which case the user will be required to correct the interference at his own expense.

This device complies with Part 15 of the FCC Rules. Operation is subject to the following two conditions: (1) This device may not cause harmful interference, and (2) this device must accept any interference received, including interference that may cause undesired operation.

### For Customers in Europe

#### Warning

This is a class A product. In a domestic environment, this product may cause radio interference, in which case the user may be required to take adequate measures.

### Environmental Information

- The equipment that you have purchased has required the extraction and use of natural resources for its production.
- The equipment may contain hazardous substances that could impact health and the environment.
- In order to avoid the dissemination of those substances in our environment and to diminish the pressure on the natural resources, we encourage you to use the appropriate take-back systems.
- The take-back systems will reuse or recycle most of the materials of end life equipment in a sound way.



- The crossed-out wheeled bin symbol invites you to use those systems. 
- If you need more information on the collection, reuse and recycling systems, please contact your local or regional waste administration.

---

## Safety Precautions

---

Before using your device, basic safety instructions should always be followed.

- (1) Follow all warnings and instructions marked on the product.
- (2) The device can only be used in a fixed location such as a telecommunication centre, a dedicated computer room.  
When you installed the device, ensure that the protective earthing connection of the socket outlet is verified by a skilled person.
- (3) The socket-outlet shall be installed near the equipment and shall be easily accessible.



- (4) Only use the cables and accessories that are included in the package. Don't use other accessories or cables unless specifically instructed to in the documentation. Also, do not use USB cables that are 3 meters or longer to connect USB devices.

---

## Warning Symbols and Graphical Icons on the Product Label

---

Warning symbols are used on the product label for the safety operation and prevention of injury to you and damage to the unit. This explains the meanings of symbols and icons used on the product label.

 WARNING	Indicates a potentially hazardous situation, which could result in death or serious injury if not careful.
 CAUTION	Indicates a potentially hazardous situation, which could result in minor or moderate injury if not careful.
	The rack-mounted equipment should not be used for a shelf or a work space.

# Contents

<b>Notice .....</b>	<b>2</b>
Regulatory Compliance Information .....	2
Safety Precautions .....	2
Warning Symbols and Graphical Icons on the Product Label .....	3
<b>Chapter 1 Getting Started .....</b>	<b>5</b>
Diagrams.....	5
Opening Windows Storage Server .....	8
Changing Settings .....	8
Configuring Date and Time .....	8
Creating a Shared Folder.....	9
Turning the TeraStation On and Off.....	14
Installing Antivirus Software .....	14
<b>Chapter 2 Preinstalled Software .....</b>	<b>15</b>
RAID Builder .....	15
Buffalo Dashboard.....	16
Email Notification .....	18
Buffalo Replication .....	19
TeraStation Backup & Replication Folder Settings.....	20
Display Settings .....	21

<b>Chapter 3 Storage Management .....</b>	<b>22</b>
<b>Working with Volumes.....</b>	<b>22</b>
Notice When Creating Volumes .....	22
Volume Types .....	22
<b>Creating a Volume .....</b>	<b>23</b>
<b>Deleting Volumes .....</b>	<b>25</b>
<b>Formatting Volumes .....</b>	<b>27</b>
<b>Enabling Data Deduplication.....</b>	<b>29</b>
<b>Chapter 4 Backup and Replication.....</b>	<b>33</b>
<b>Backing Up in Windows Storage Server .....</b>	<b>33</b>
Preparing a Backup Destination.....	33
Recovering Backup Data .....	38
<b>Configuring Replication .....</b>	<b>42</b>
Differences Between Buffalo Replication and DFS Replication .....	42
Before Using Replication.....	43
Buffalo Replication .....	43
DFS Replication .....	46
<b>Chapter 5 Additional Settings .....</b>	<b>63</b>
<b>Changing Server Name, Workgroups, and Domains.....</b>	<b>63</b>
<b>Changing the Password .....</b>	<b>65</b>
Administrator's Password .....	65
Passwords for Other Users .....	66
<b>Adding a User .....</b>	<b>67</b>
<b>Connecting with Standard Accounts .....</b>	<b>68</b>
<b>Adding a Group .....</b>	<b>72</b>

<b>Enabling Email Notification .....</b>	<b>74</b>
<b>Configuring Email Server .....</b>	<b>74</b>
<b>Specifying TeraStation Reports .....</b>	<b>76</b>
<b>Specifying Windows Event Logs .....</b>	<b>78</b>
<b>Changing Front Panel Settings .....</b>	<b>79</b>
<b>Acquiring Windows Event Logs.....</b>	<b>79</b>
<b>Configuring NIC Teaming .....</b>	<b>81</b>
<b>Enabling Wake-on-LAN.....</b>	<b>83</b>

## **Chapter 6 Drive Replacement..... 87**

<b>LEDs.....</b>	<b>87</b>
<b>Notice Before Drive Replacement.....</b>	<b>87</b>
<b>Example of Drives 1 and 2 .....</b>	<b>88</b>
<b>Example of Drives 3 and 4 .....</b>	<b>93</b>

## **Chapter 7 Utilities..... 98**

<b>NAS Navigator2 for Windows.....</b>	<b>98</b>
<b>Changing the IP Address .....</b>	<b>100</b>
<b>NAS Navigator2 for Mac .....</b>	<b>101</b>
<b>Changing the IP Address .....</b>	<b>103</b>
<b>NovaBACKUP .....</b>	<b>103</b>

## **Chapter 8 Troubleshooting..... 104**

<b>The TeraStation Becomes Unaccessible .....</b>	<b>104</b>
<b>Shared Folders Suddenly Do Not Open.....</b>	<b>105</b>

<b>Unable to Access the Shared Folder or the System Becomes Unstable.....</b>	<b>105</b>
<b>I12 Message Appears Despite No Drive Errors .....</b>	<b>105</b>
<b>TeraStation Does Not Boot .....</b>	<b>107</b>
<b>Notice Before Recovery .....</b>	<b>107</b>
<b>Recovering Windows Storage Server .....</b>	<b>107</b>
<b>Additional Information.....</b>	<b>108</b>

**Chapter 9 Appendix ..... 109**

<b>LCD Panel .....</b>	<b>109</b>
<b>Modes .....</b>	<b>109</b>
<b>Errors and Status.....</b>	<b>109</b>
<b>Default Settings .....</b>	<b>110</b>
<b>Specifications .....</b>	<b>111</b>

# Chapter 1 Getting Started

## Diagrams

### WS5220DN6

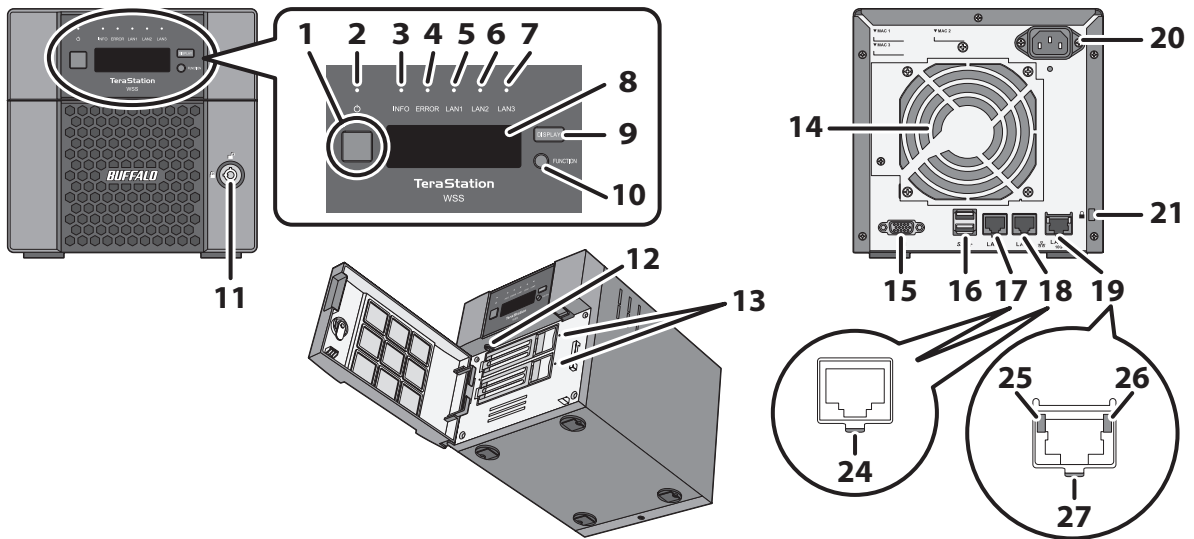

### WS5420DN6

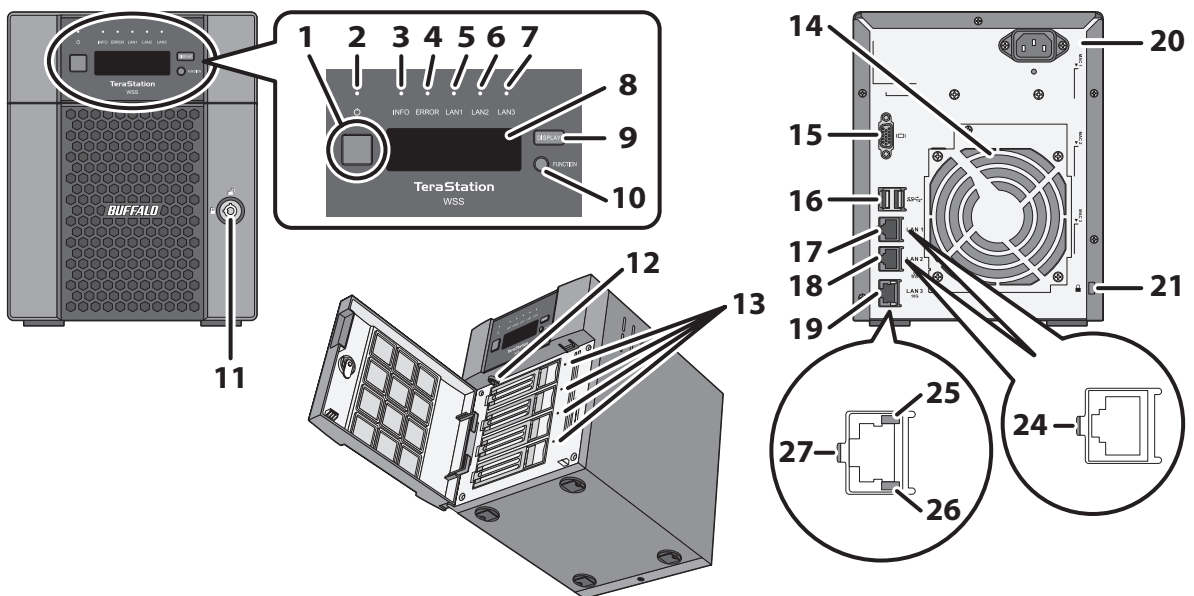



## WS5420RN6

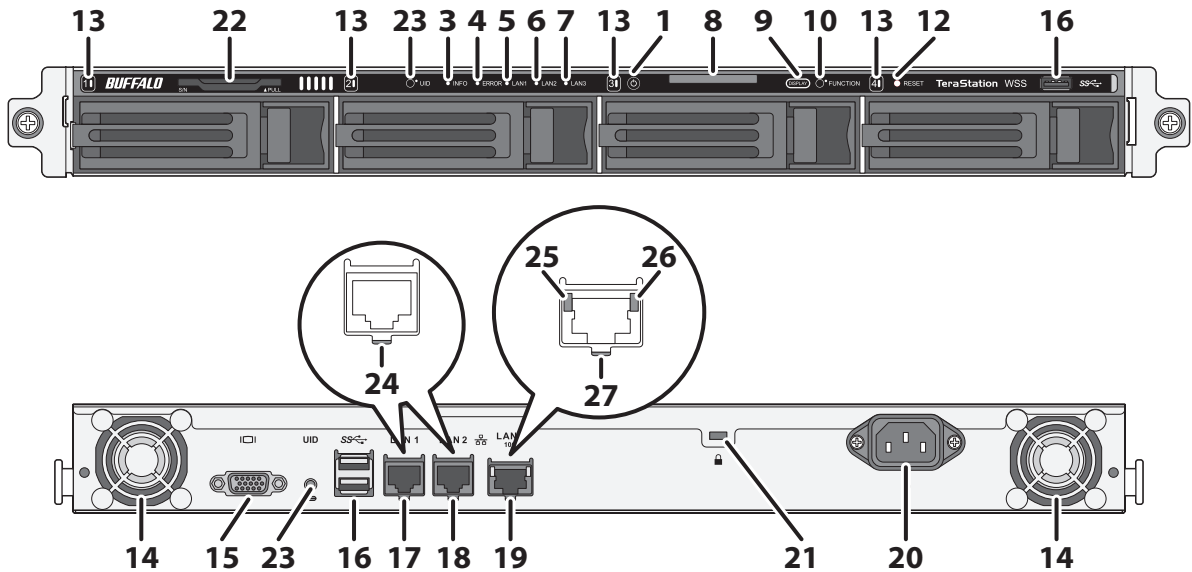

### 1 Power Button (⏻)

To power on, connect the power cable and wait for 10 seconds, then press the power button. To power off, press the power button.

### 2 Power LED

When the TeraStation is on, the LED glows green.

### 3 Info LED

If there is a status message, the amber info LED will light up. Check the LCD panel to see the status message.

### 4 Error LED

If there is an error, the red error LED will light up. Check the LCD panel to see the error message.

### 5 LAN1 LED

When LAN port 1 is connected, this LED glows green. It blinks when the connection is active.

### 6 LAN2 LED

When LAN port 2 is connected, this LED glows green. It blinks when the connection is active.

### 7 LAN3 LED

When LAN port 3 is connected, this LED glows blue. It blinks when the connection is active.

### 8 LCD Panel

This display shows the status of many TeraStation settings. It also displays errors and messages if any appear.

### 9 Display Button

Switches between the different display modes. Also, if the TeraStation beeps, pressing this button will stop the beeping.

### 10 Function Button

Use this button for performing recovery or stopping the TeraStation's beeping.

### 11 Drive Lock (🔒 🔓)

Open the front panel with the key to replace drives or access the reset button.

## 12 Reset Button

To shut down and reboot the TeraStation, press and hold this button.

## 13 Status LEDs

Normally, these LEDs blink green when drives are accessed. If a drive fails, its LED will turn red.

## 14 Fan

Spins to avoid overheating inside. Do not block the fan.

## 15 VGA Port ( )

You can connect a VGA monitor to this port. Connecting a monitor directly to the TeraStation is only supported for monitoring the progress of Windows Update.

## 16 USB 3.0 Port ( )

Compatible Buffalo USB drives, USB memory devices, and USB UPS devices can be connected. USB hubs are not supported.

## 17 LAN Port 1 ( )

Connect an Ethernet cable to use this network port. It is available for communicating at max. 1000 Mbps.

## 18 LAN Port 2 ( )

Connect an Ethernet cable to use this network port. It is available for communicating at max. 1000 Mbps.

## 19 LAN Port 3 ( )

Connect an Ethernet cable to use this network port. It is available for communicating at max. 10 Gbps if using the included Ethernet cable or category 6A cable.

## 20 Power Connector

Use the included power cable to connect to a UPS, surge protector, or outlet.

## 21 Anti-Theft Security Slot ( )

Use this slot to secure your TeraStation with a cable lock (not included).

## 22 Serial Number

This sticker shows the TeraStation's serial number.

## 23 UID Button

Press the UID button on the front or the back of the TeraStation to cycle the blue LED on and off.

## 24 Link/Act LED

Glows green when the TeraStation is connected to a network. It blinks when the connection is active.

## 25 Link/Act LED on 100 Mbps

Glows amber when the TeraStation is connected to a network at 100 Mbps. It blinks when the connection is active.

## 26 Link/Act LED on 1000 Mbps, 2.5 Gbps, and 5 Gbps

Glows green when the TeraStation is connected to a network at 1000 Mbps, 2.5 Gbps, or 5 Gbps. It blinks when the connection is active.

## 27 Link/Act LED on 10 Gbps

Glows blue when the TeraStation is connected to a network at 10 Gbps. It blinks when the connection is active.

---

## Opening Windows Storage Server

---

To connect Windows Storage Server, follow the procedure below.

**Note:** If using macOS, download and install “Microsoft Remote Desktop” from the Mac App Store.

- 1 Double-click the  icon to start NAS Navigator2.
- 2 Right-click your TeraStation’s icon and select *Open Remote Desktop*. For macOS, select the TeraStation’s icon while holding down the control key, then select *Open Remote Desktop*.

If the message “The identity of the remote computer cannot be verified. Do you want to connect anyway?” is displayed, click *Yes* or *Continue*.

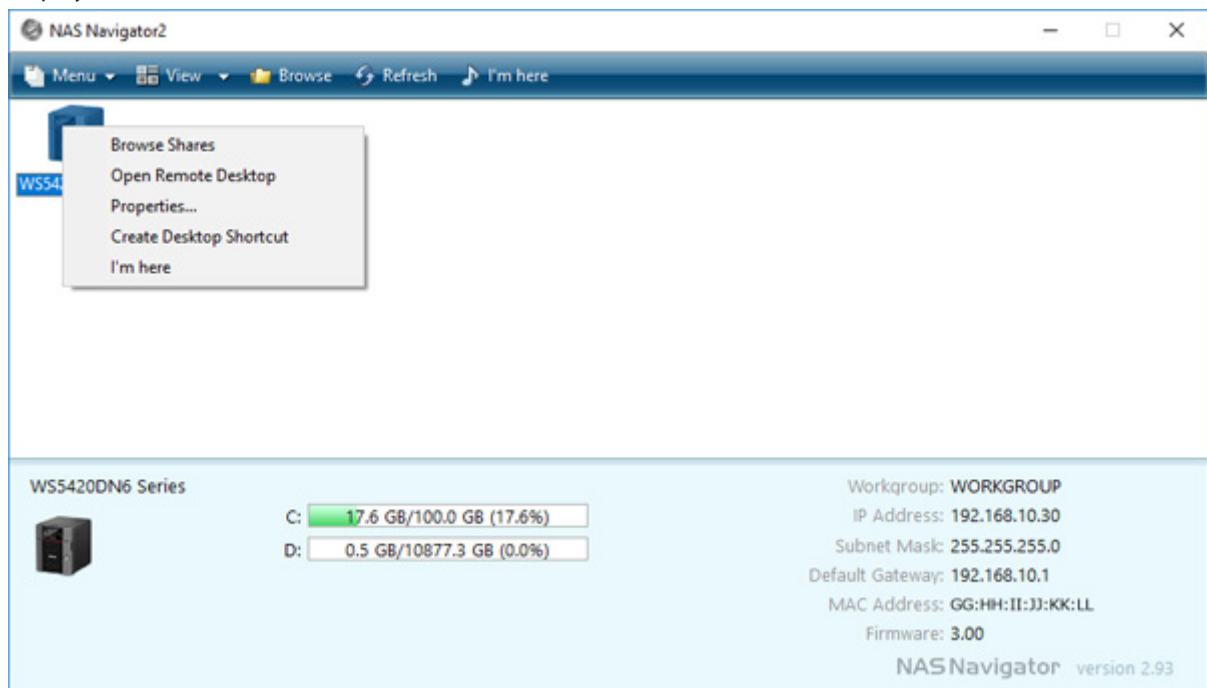

- 3 Enter the admin username and password and press the Enter key. The default username and password are “Administrator” and “password”.

Windows Storage Server will open in the remote desktop.

---

## Changing Settings

---

### Configuring Date and Time

---

- 1 Click the time in the system tray of Windows Storage Server.

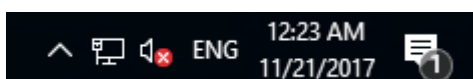

**2** Click *Change date and time settings* > *Change date and time*, select the current date and time, and click *OK*.

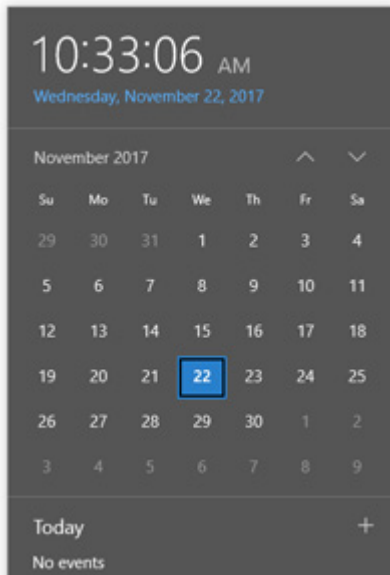

**Note:** From the *Internet Time* tab, click *Change settings*, then select *Synchronize with an Internet time server*. The date and time can be obtained automatically.

## Creating a Shared Folder

No shared folders are configured by default. Before using the TeraStation, follow the procedure below to create one or more shared folders.

This is an example to create a shared folder, named “Share” in drive D, which anyone can access.

**1** From Server Manager, click *Tools* > *Computer Management*.

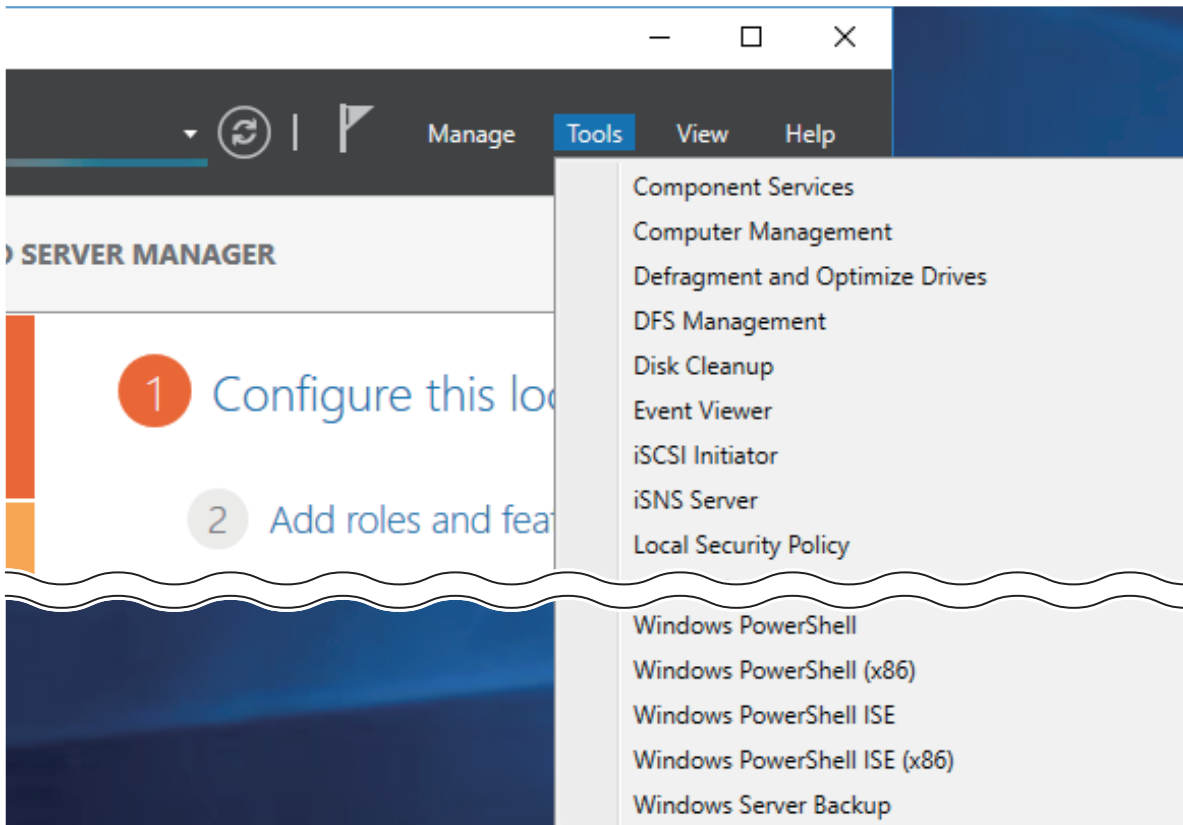

**2** Click *Shared Folders*.

**3** Right-click *Shares* and click *New Share*.

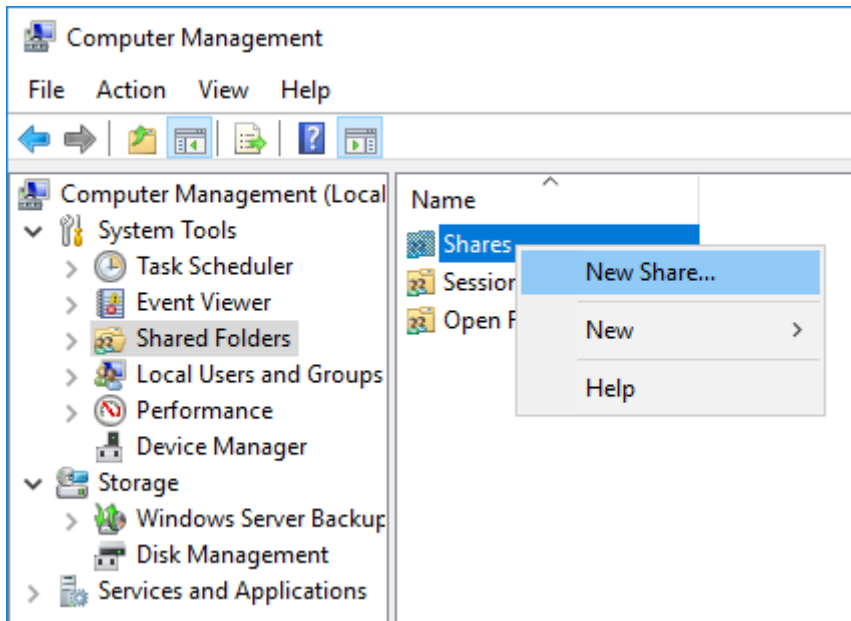

**4** Click *Next*.

**5** Enter the path of an existing folder or a new folder, then click *Next*.

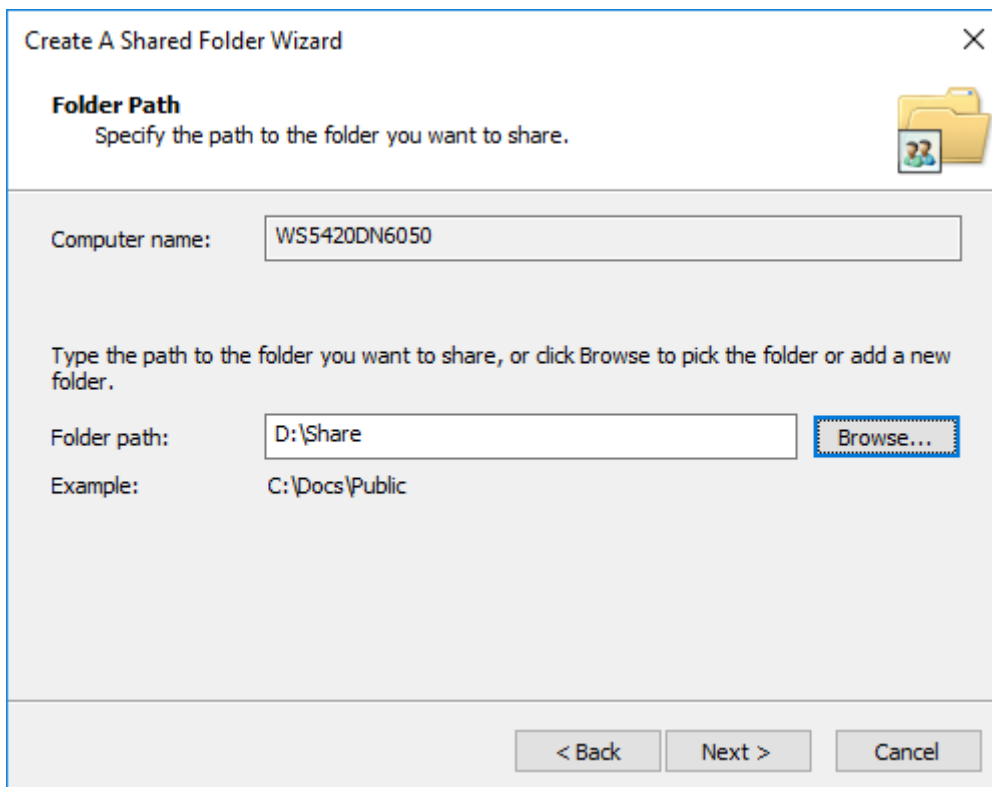

**Notes:**

- Enter "D:\Share" into the folder path to create the shared folder for the first time.
- If the message "The system cannot find the specified path. Do you want to create it?" is displayed, click Yes.

6 Enter a name for the share and a description (optional), then click *Next*.

The screenshot shows the 'Create A Shared Folder Wizard' dialog box. The title bar reads 'Create A Shared Folder Wizard' with a close button (X) on the right. Below the title bar, the section is titled 'Name, Description, and Settings' with a subtitle 'Specify how people see and use this share over the network.' and a folder icon with a person icon. The main area contains the following fields and controls:

- Share name: A text box containing 'Share'.
- Share path: A text box containing '\\WS5420DN6050\Share'.
- Description: An empty text box.
- Offline setting: A dropdown menu showing 'Selected files and programs available offline' and a 'Change...' button to its right.

At the bottom of the dialog, there are three buttons: '< Back', 'Next >' (highlighted with a blue border), and 'Cancel'.

7 Select "Customize permissions", then click *Custom*.

The screenshot shows the 'Create A Shared Folder Wizard' dialog box. The title bar reads 'Create A Shared Folder Wizard' with a close button (X) on the right. Below the title bar, the section is titled 'Shared Folder Permissions' with a subtitle 'Permissions let you control who can see the folder and the level of access they have.' and a folder icon with a person icon. The main area contains the following elements:

- Text: 'Set the kind of permissions you want for the shared folder.'
- Four radio button options:
  - All users have read-only access
  - Administrators have full access; other users have read-only access
  - Administrators have full access; other users have no access
  - Customize permissions
- A 'Custom...' button below the 'Customize permissions' option.
- Text: 'By default, only share permissions are set on this folder. To control local access permissions to this folder or objects within the folder, click Custom... and then modify the permissions on the Security tab to apply specific permissions on the folder.'

At the bottom of the dialog, there are three buttons: '< Back', 'Finish' (highlighted with a blue border), and 'Cancel'.

8 Choose *Everyone* and select the “Allow” checkbox for “Change”.

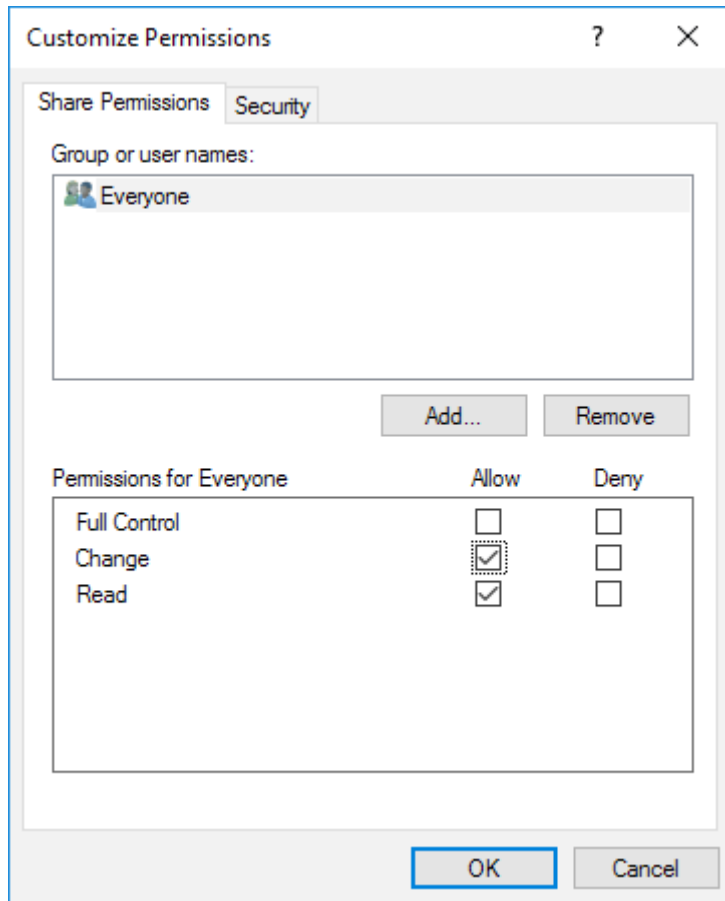

9 From the *Security* tab, click *Edit > Add*.

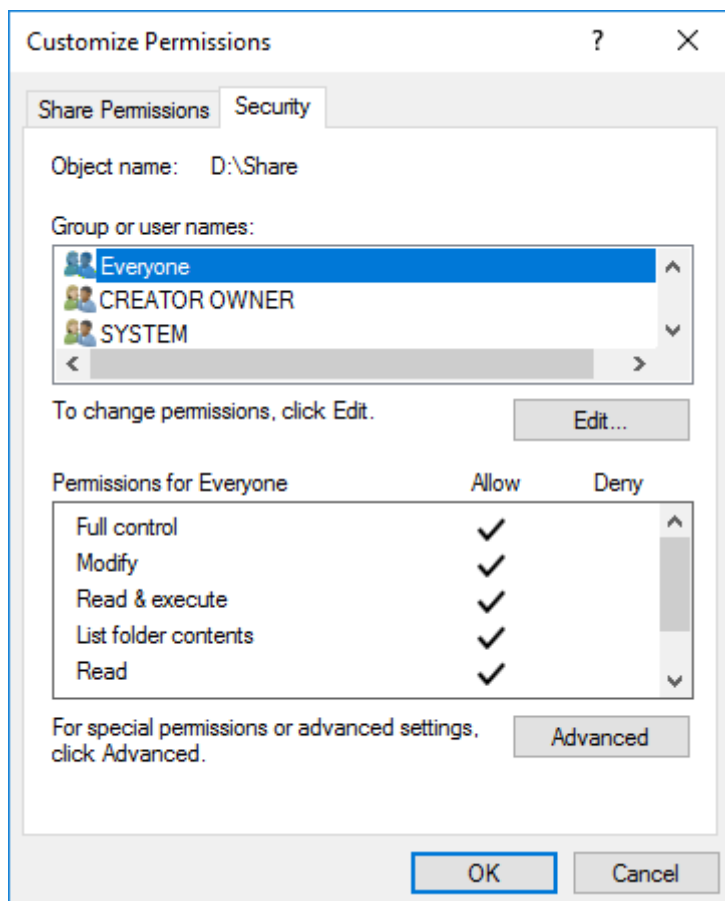

**10** Enter "Everyone" under "Enter the object names to select", then click *OK*.

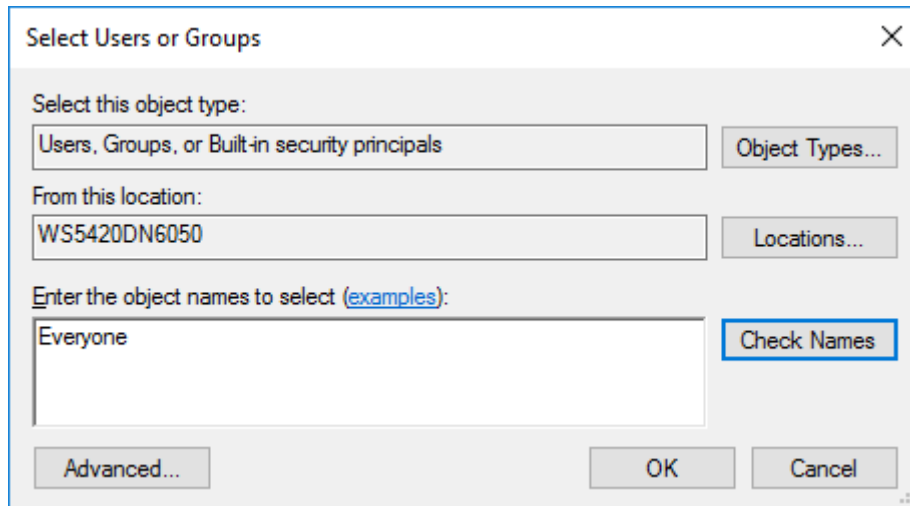

**11** Choose "Everyone", then select the "Allow" checkbox for *Modify*.

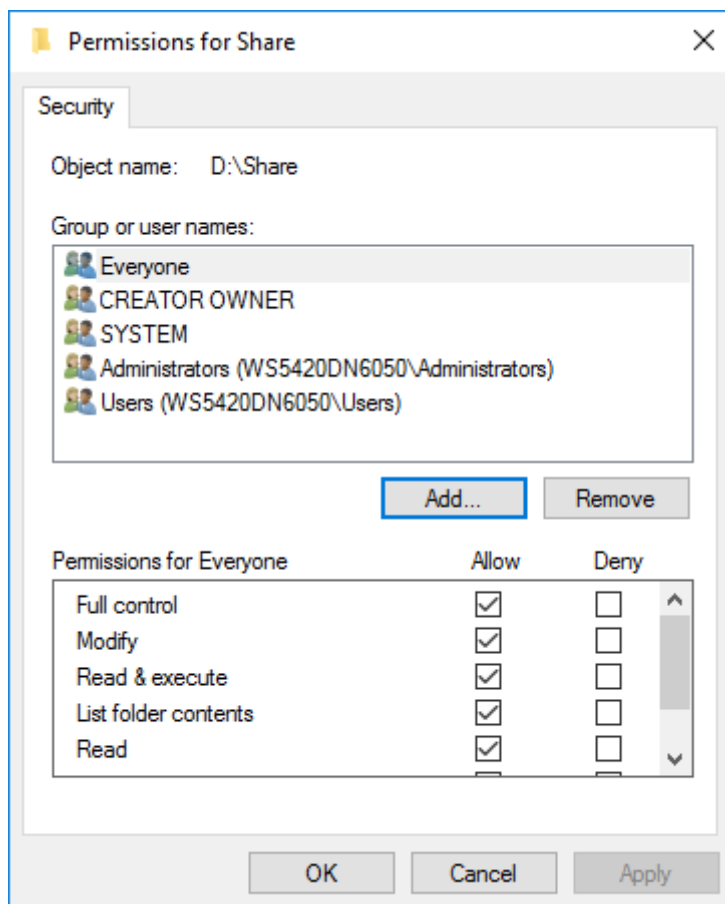

**12** Click *OK* > *OK* > *Finish* > *Finish*.

**Notes:**

**Enable a guest account:**

- (1) From Server Manager, click *Tools* > *Computer Management*.
- (2) Click *Local Users and Groups*.
- (3) Double-click *Users* > *Guest*.
- (4) From the *General* tab, clear the "Account is disabled" checkbox, then click *OK*.

**Enable access permissions:**



- (1) From Server Manager, click *Tools > Computer Management*.
- (2) Click *Shared Folders*.
- (3) Double-click *Shares*, then double-click the desired shared folder.
- (4) From the *Security* tab, click *Edit*.
- (5) From the *Local Users and Groups* list, add the users or groups that will be allowed access (the groups and users must be created beforehand). To allow access for all users, add a guest and change Administrator's "Access Permission" to "Full Control".

---

## Turning the TeraStation On and Off

---

Press the power button on the TeraStation to turn it on and off. Or you can turn off your TeraStation by following the procedure below.

- 1** Click the Start button.

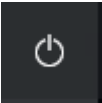
- 2** Click the  icon, then *Shut down*.

- 3** Select the reason why you want to shut down, then click *Continue*.

When the power LED on the front of the TeraStation turns off, the shutdown process is complete.

**Note:** Always shut down the TeraStation before unplugging it. The TeraStation can be damaged if it is suddenly unplugged without being powered down first.

---

## Installing Antivirus Software

---

Installing antivirus software on the TeraStation is strongly recommended. The installation process may vary depending on which antivirus software you use.

# Chapter 2 Preinstalled Software

The following software is preinstalled on the TeraStation.

- RAID Builder
- Buffalo Dashboard
- Email Notification
- Buffalo Replication
- TeraStation Backup & Replication Folder Settings
- Display Settings

---

## RAID Builder

---

RAID Builder is used to create RAID volumes. See the “Storage Management” chapter for more details. To launch RAID Builder, you must be logged in as a member of the Administrators group in Windows Storage Server.

**Note:** This software cannot be accessed by multiple users at the same time. Before launching it, make sure that it is not being used by another user.

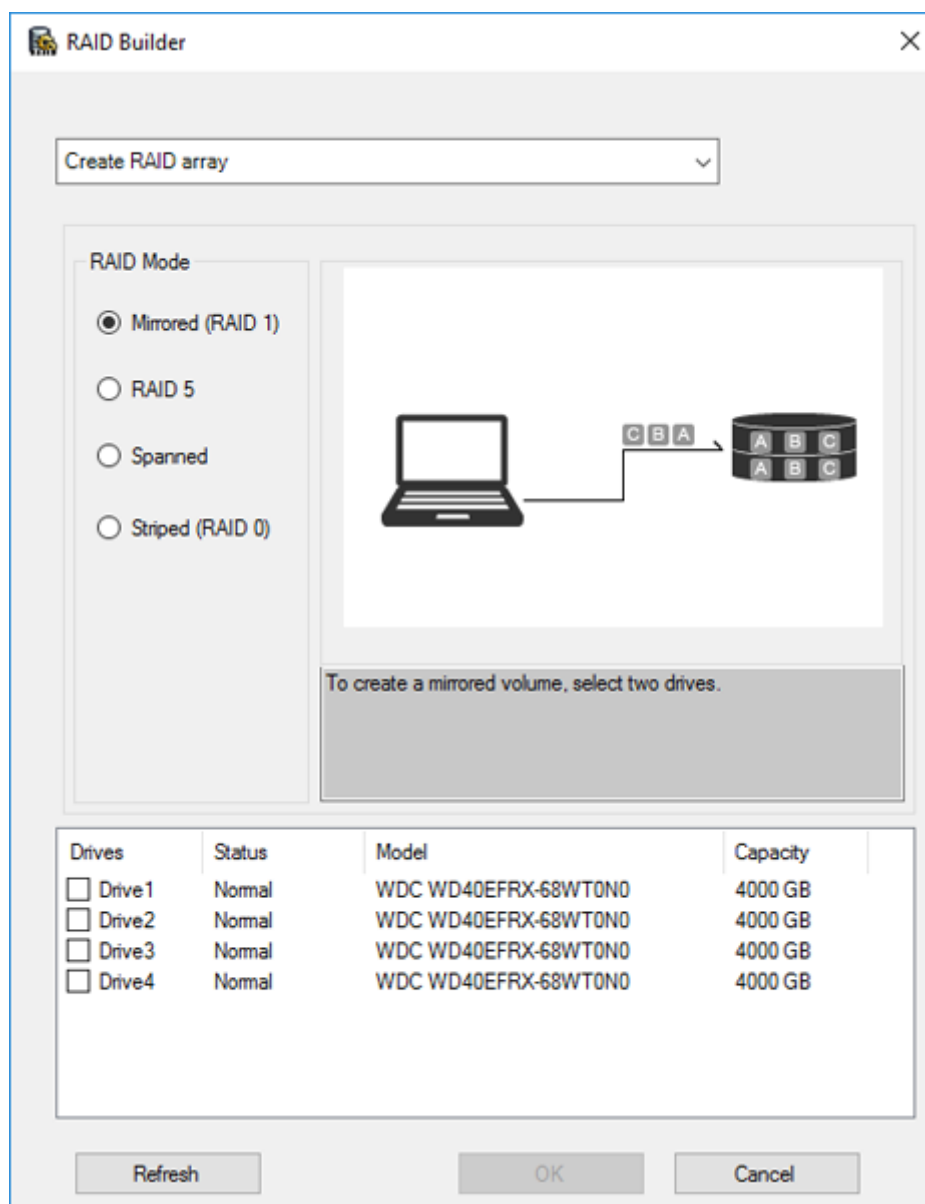

---

## Buffalo Dashboard

---

Buffalo Dashboard displays system information and dismounts hard drives. To launch it, double-click the Buffalo

Dashboard icon  in the system tray.

**Note:** This software cannot be accessed by multiple users at the same time. Before launching it, make sure that it is not being used by another user.

The screenshot shows the Buffalo Dashboard interface. At the top left is the Buffalo logo and 'Buffalo Dashboard' text. At the top right is 'Buffalo Dashboard' and 'Version 1.0.6562.21152'. The main content is divided into several sections:

- System Information:** A table with fields: Product Name (WS5420DN6), Computer Name (WS5420DN6050), Domain Name (WORKGROUP), OS (Microsoft Windows Storage Server 2016 Standard), OS Version (10.0.14393), Firmware (3.00), and Manufacturer (Buffalo Inc.). There is a 'Check for updates' checkbox which is checked, and a message: 'The latest firmware has already been installed.'
- Network Information:** A table with columns: Status, LAN, Adapter Name, and IPv4 Address. It shows three LAN ports: LAN 1 (Up, Ethernet, 192.168.10...), LAN 2 (Down, Ethernet 2), and LAN 3 (Down, Ethernet 3).
- Temperature:** Shows 'System : 39°C / 102°F'.
- Fan:** Shows 'Fan 1 : 2463 RPM'.
- Backup:** Shows 'Buffalo Replication : Replication is synchronized.' and 'Windows Server Backup : No logs available.'
- Drive:** A table with columns: Status, Drive, Name, Capacity, and Physical ... It shows four drives, all with status 'Normal' and capacity '3.639 TB'. There are 'Refresh' and 'Dismount Drive...' buttons below.
- I'm here!:** A section with the text 'The "I'm here" button will cause your TeraStation to beep.' and an 'I'm here!' button.
- Operation When Power Is Restored:** A dropdown menu currently set to 'Power off'.

Items	Descriptions
System Information	<p><b>Product Name:</b> Displays the model name of the TeraStation.</p> <p><b>Computer Name:</b> Displays the hostname of the TeraStation.</p> <p><b>Domain Name:</b> Displays the type of domain that the TeraStation is a member of.</p> <p><b>OS:</b> Displays the type of Windows installed on the TeraStation.</p> <p><b>OS Version:</b> Displays the version of the OS.</p> <p><b>Firmware:</b> Displays the firmware version of the TeraStation.</p> <p><b>Check for updates:</b> Enables or disables checking for new firmware releases. When a new firmware version is available, you will be notified here.</p> <p><b>Manufacturer:</b> Displays "Buffalo Inc."</p>
Temperature	Displays the temperature of the system.
Fan	Displays the fan rpm.
Backup	Displays the status of backup and replication.
Network Information	Displays IP addresses, subnet masks, default gateways, LAN port numbers, link speed, and status.
I'm here!	Causes your TeraStation to beep.

Items	Descriptions
Drive	<p>Displays the status, drive numbers, names, capacity, and physical sector sizes of each drive.</p> <p><b>Refresh:</b> Updates the displayed drive information.</p> <p><b>Dismount Drive:</b> Dismounts a drive for safe removal. Select the drive to dismount and click <i>OK</i>.</p> <p><b>Options:</b></p> <ul style="list-style-type: none"> <li>• <b>Shut down the TeraStation when the temperature of the drive becomes abnormally high:</b> The TeraStation will automatically shut down if the drive gets too hot.</li> <li>• <b>Turn off the drive if an error occurs:</b> The hard drive will automatically be turned off (dismounted) if a drive error occurs.</li> </ul> <p><b>How to Dismount Drives:</b> Click <i>Dismount Drive</i>, check the drive to dismount, then click <i>OK</i>. After the drive is dismounted, unplug the hard drive from the TeraStation.</p>
Operation When Power Is Restored	<p>Configures the action to be taken after recovering from a power failure.</p> <ul style="list-style-type: none"> <li>• <b>Return to last state before power failure:</b> The TeraStation will be restored to the state before the power failure. If the TeraStation was turned off, it will remain powered off even if power is restored. If the TeraStation was on, it will be powered on when power is restored.</li> <li>• <b>Power on:</b> Turns the TeraStation on after power is restored.</li> <li>• <b>Power off:</b> The TeraStation will remain off after power is restored.</li> </ul>

**Note:** The following functions are only available when logged in as administrator:

- Refresh
- Dismount drive
- Options
- Check for updates
- Operation when power is restored

---

## Email Notification

---

Your TeraStation can send you email reports when settings are changed or an error occurs. See the “Enabling Email Notification” section in chapter 5 for more details.

To launch Email Notification, you must be logged in as a member of the Administrators group in Windows Storage Server.

**Note:** This software cannot be accessed by multiple users at the same time. Before launching it, make sure that it is not being used by another user.

**Email Notification**

Enable email notification

Send to

Email Address:

New Edit Delete

Authentication

SMTP Server Address:   Port Number:

User Authentication Method:

POP Server Address:  Port Number:

Username:  Password:

SSL/TLS:

Accept untrusted or self-signed certificates

Email Settings

Sender Address:

Title:

Content Options

Test Message OK Cancel Apply

---

## Buffalo Replication

---

Your TeraStation can be synchronized with another TeraStation, replicating most data. See the “Configuring Replication” section in chapter 4 for more details.

To launch Buffalo Replication, you must be logged in as a member of the Administrators group in Windows Storage Server.

**Note:** This software cannot be accessed by multiple users at the same time. Before launching it, make sure that it is not being used by another user.

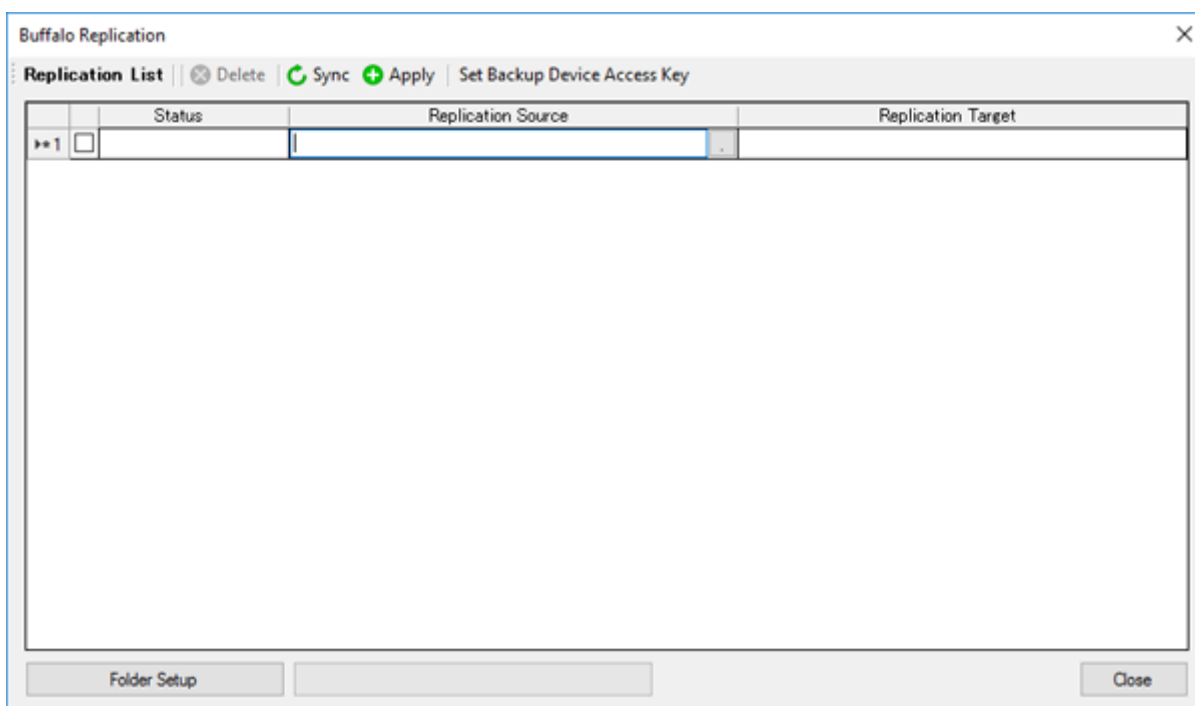

## TeraStation Backup & Replication Folder Settings

Before using it as a backup device on the network, configure your TeraStation in “TeraStation Backup & Replication Folder Settings”.

To launch TeraStation Backup & Replication Folder Settings, you must be logged in as a member of the Administrators group in Windows Storage Server.

**Note:** This software cannot be accessed by multiple users at the same time. Before launching it, make sure that it is not being used by another user.

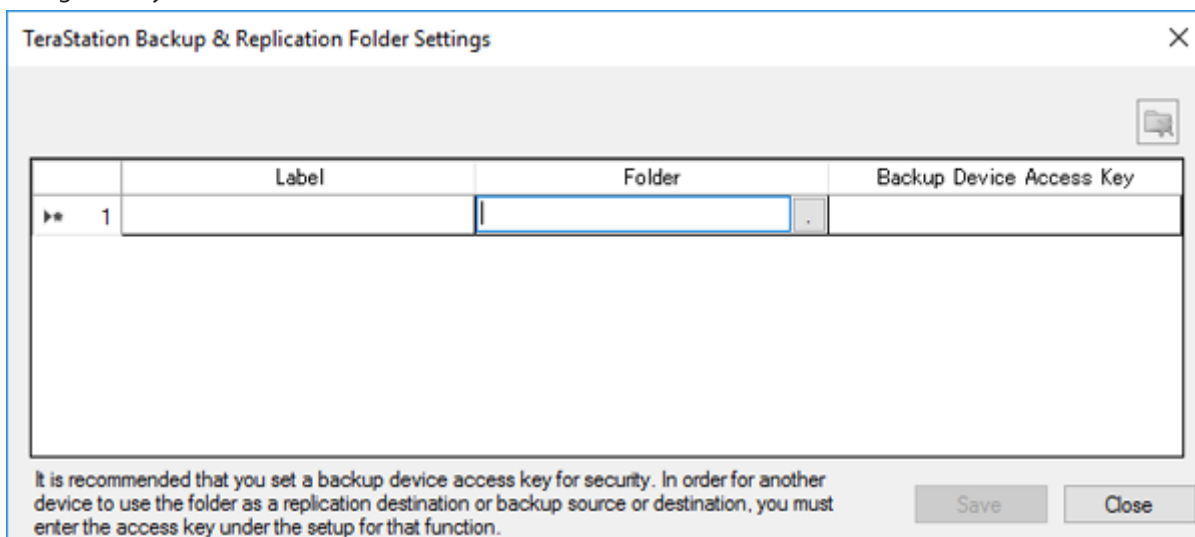

Items	Descriptions
Label	Enter a name for the backup or replication destination. When you search for backup devices on the network, this name will appear.
Folder	Specify a shared folder where backup data will be stored. Do not select the root directory where the shared folder is created.

Items	Descriptions
Backup Device Access Key	Enter the desired characters for a backup device access key. The backup device access key may contain up to 8 alphanumeric characters, hyphens (-), and underscores (_). The first character should not be a symbol. You may leave this field blank if you do not want a backup device access key, but for security reasons we highly recommend entering one for the shared folder. If a backup device access key is configured for the shared folder, that folder will not show up as a target for the replication destination or backup source or destination when configuring a backup job on another Buffalo device unless it's entered.
	To remove a folder from the list of available backup targets, select the folder and click this button.
Save	Saves the settings.
Close	Exits TeraStation Backup & Replication Folder Settings.

## Display Settings

TeraStation's LCD panel settings can be changed using this software. See the "Changing Front Panel Settings" section in chapter 5 for more details.

To launch Display Settings, you must be logged in as a member of the Administrators group in Windows Storage Server.

**Note:** This software cannot be accessed by multiple users at the same time. Before launching it, make sure that it is not being used by another user.

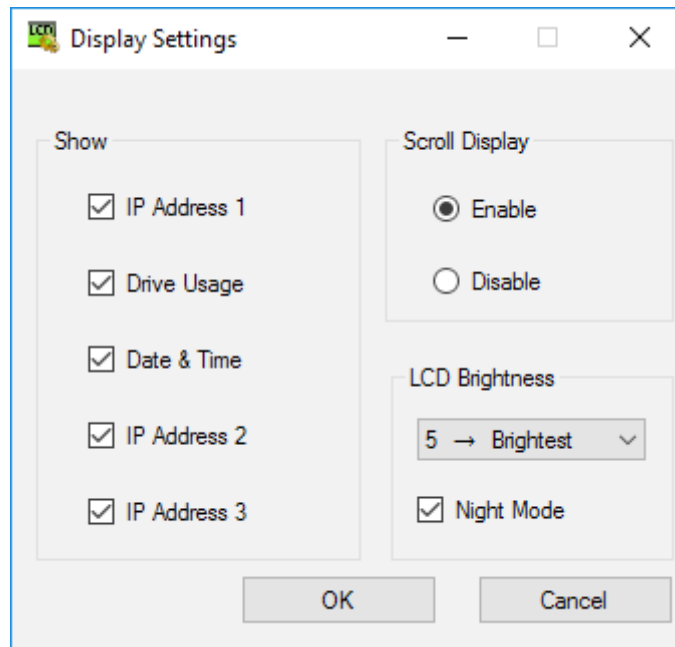



# Chapter 3 Storage Management

---

## Working with Volumes

---

### Notice When Creating Volumes

---

- To create a volume, use RAID Builder instead of the Disk Management option in Windows Storage Server.
- When volumes are deleted, formatted, or changed to another volume type, all data stored on the volumes is erased. Before executing these operations, back up any important data.
- In this manual, “recover” means reverting the TeraStation (including the data) to its former state prior to the drive failure. It doesn’t refer to reading data from a failed drive.
- After a volume is created, unused extra space can’t be added to the volume.
- Some space on each drive is not accessible because it is used by the system. The amount used on each drive is below.
  - Drives 1 and 2: 50 MB each
  - Drives 3 and 4: 100.15 GB each

### Volume Types

---

#### RAID 5 Volumes

The unallocated areas of three or more drives are used as a single volume. The usable space is equal to the sum of the capacity of the drives minus the capacity of one drive. If one drive in a RAID 5 volume fails, data on the volume can be recovered after the failed drive is replaced. However, if two or more drives fail, all data is lost.

#### Mirrored Volumes

The unallocated areas of two drives are combined into a single volume. The usable space is equal to the capacity of a single drive. Because the same data is written to both drives simultaneously, if one drive fails, data can be recovered from the other drive. If both drives in the volume fail, data cannot be recovered.

#### Striped Volumes

The unallocated areas of two or more drives are combined into a single volume. The usable space is equal to the sum of the capacity of the drives. Data cannot be recovered if even a single drive fails.

#### Spanned Volumes

The unallocated areas of multiple drives are joined to create a single logical volume. This allows various drive spaces to be combined efficiently. The usable space is equal to the sum of the capacity of the drives. Data cannot be recovered if even a single drive fails.

# Creating a Volume

To create a volume, follow the procedure below. Successfully following the procedure will erase all data stored on the volumes.

- 1 From Server Manager, click *Tools > Computer Management*.

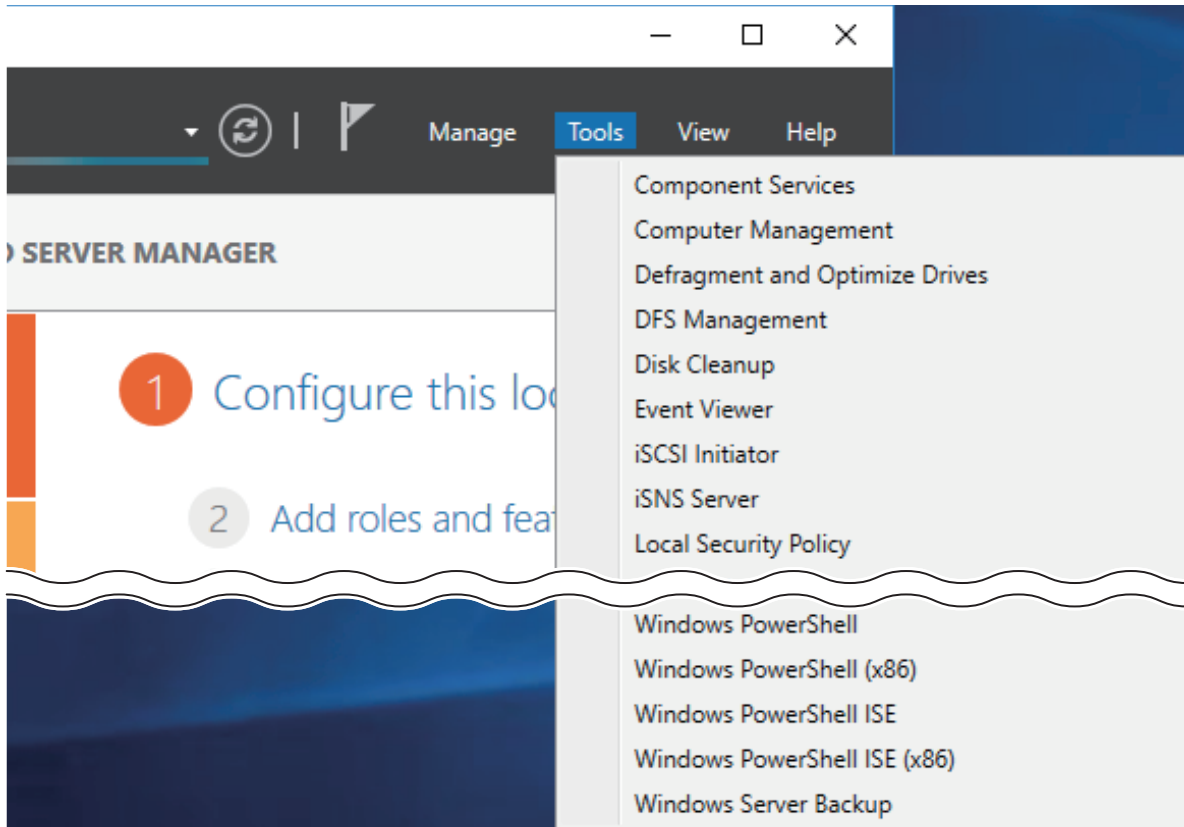

- 2 Click *Disk Management*.

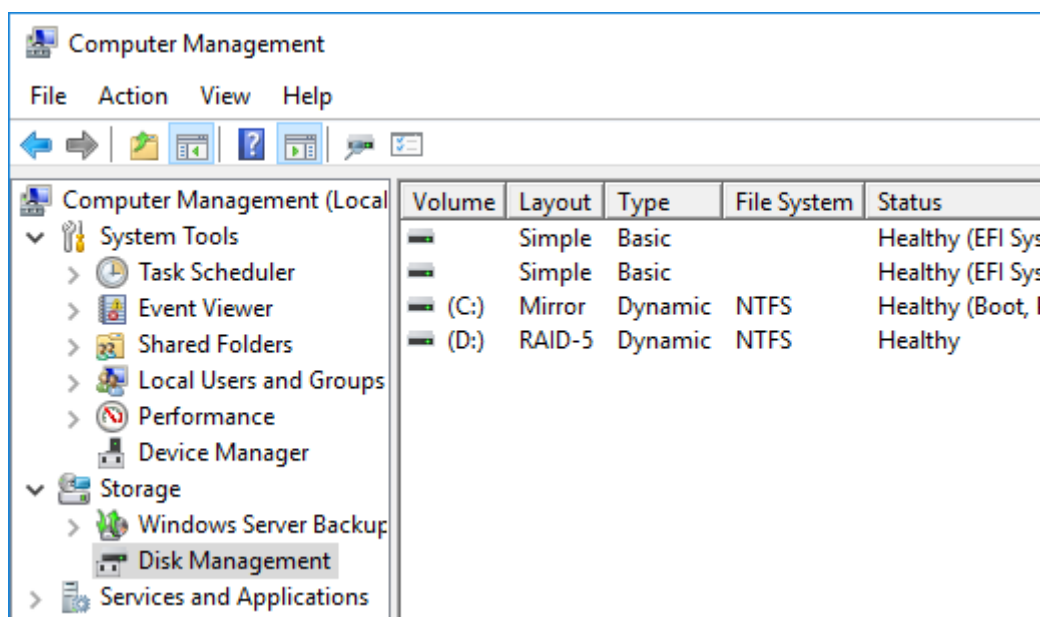

**3** Right-click the volume that you want to delete and then select *Delete Volume*.

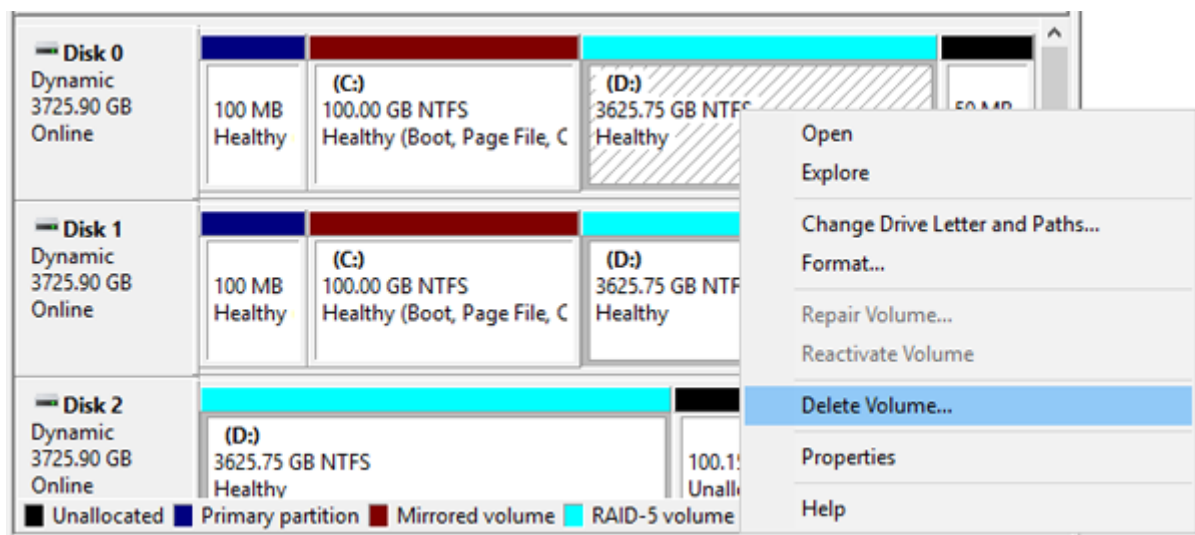

**4** Read the warning message carefully about the data that will be erased and click Yes.

**5** Click the Start button, then *RAID Builder*.

- 6 Select “Create RAID array” from the drop-down menu and select the volume type under “RAID Mode”.

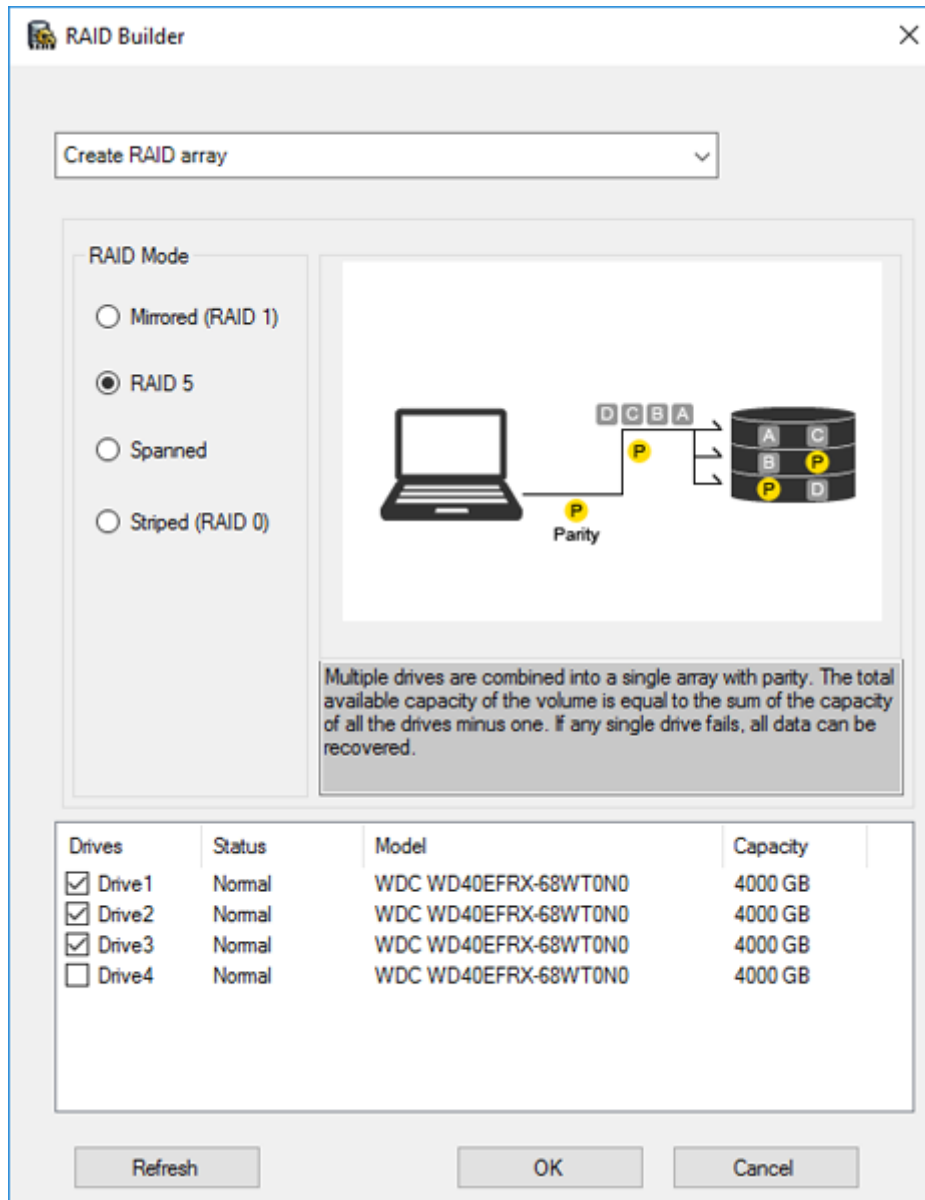

- 7 Select the drives to create a volume. If creating a RAID 5 volume, at least three drives are required. If creating a volume other than RAID 5 volume, at least two drives are required.

- 8 Click OK. Resynchronization will run automatically. File transfers and system performance will be slower while resynchronization is running, which will take about 23 hours for a RAID 5 volume and about 2–3 hours for a mirrored volume per a 4 TB TeraStation model. Resynchronization cannot be canceled.

After creating a volume is completed, refer to chapter 7 to create a shared folder.

---

## Deleting Volumes

---

If the volume shows the status “Failed”, two or more volumes have been corrupted. In such a case, data on the volume can no longer be recovered.

1 From Server Manager, click *Tools > Computer Management*.

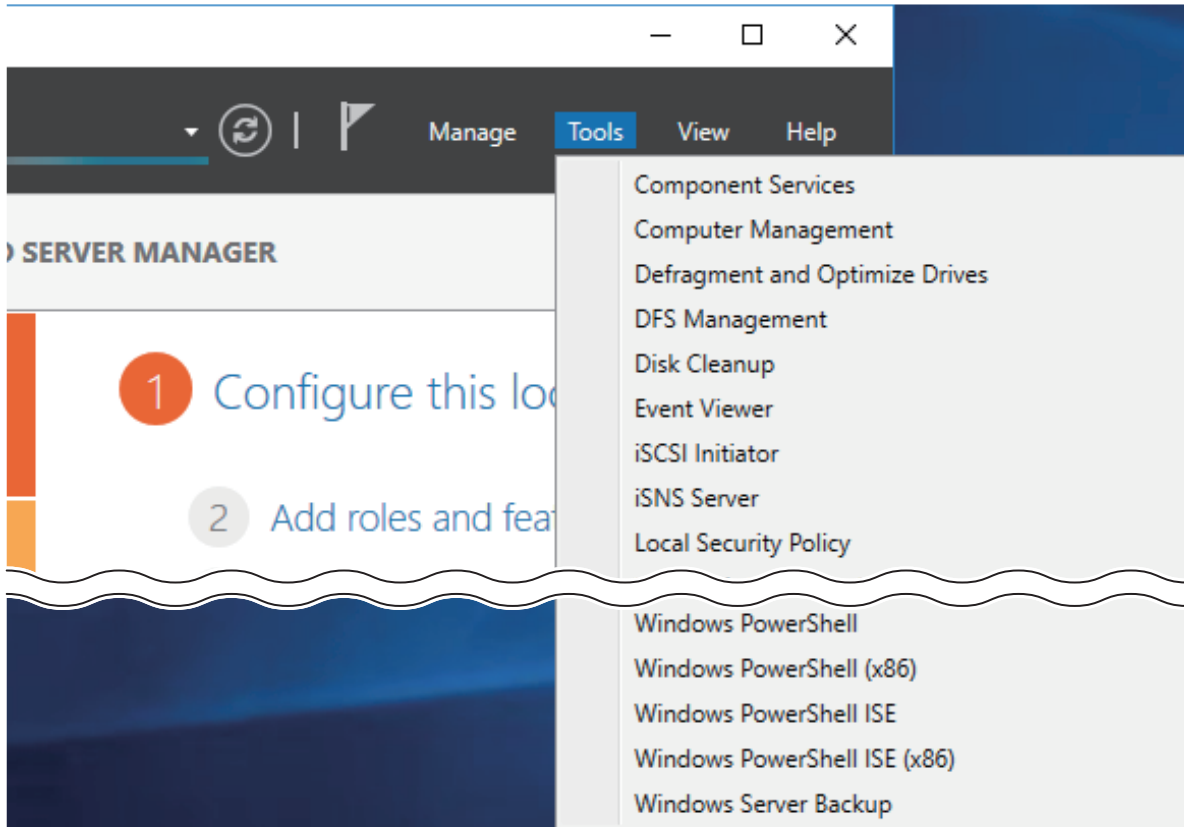

2 Click *Disk Management*.

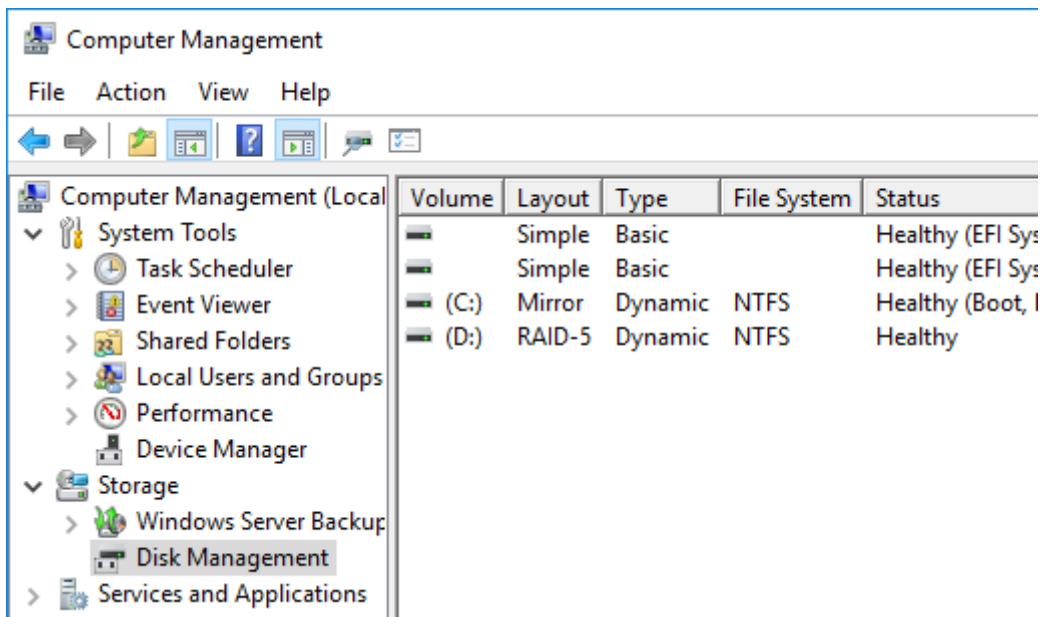

**3** Right-click the volume labeled “Failed” and click *Delete Volume*.

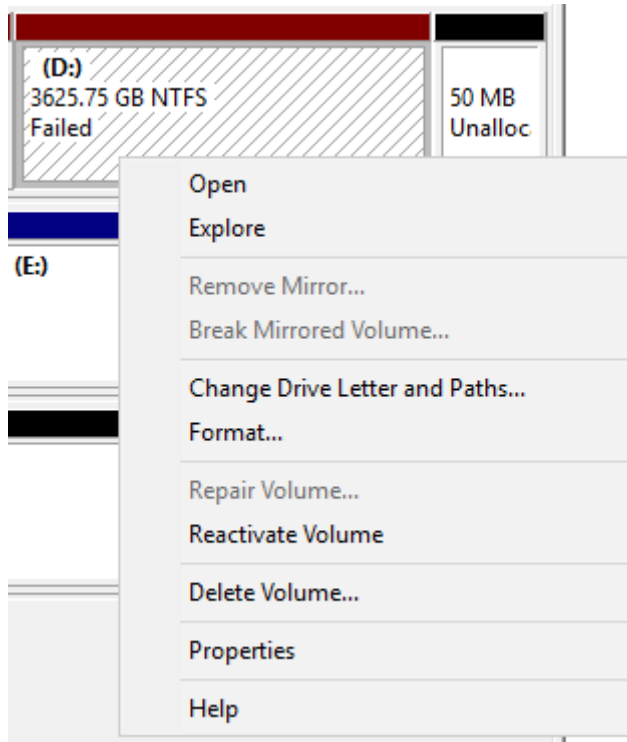

---

## Formatting Volumes

---

**1** From Server Manager, click *Tools > Computer Management*.

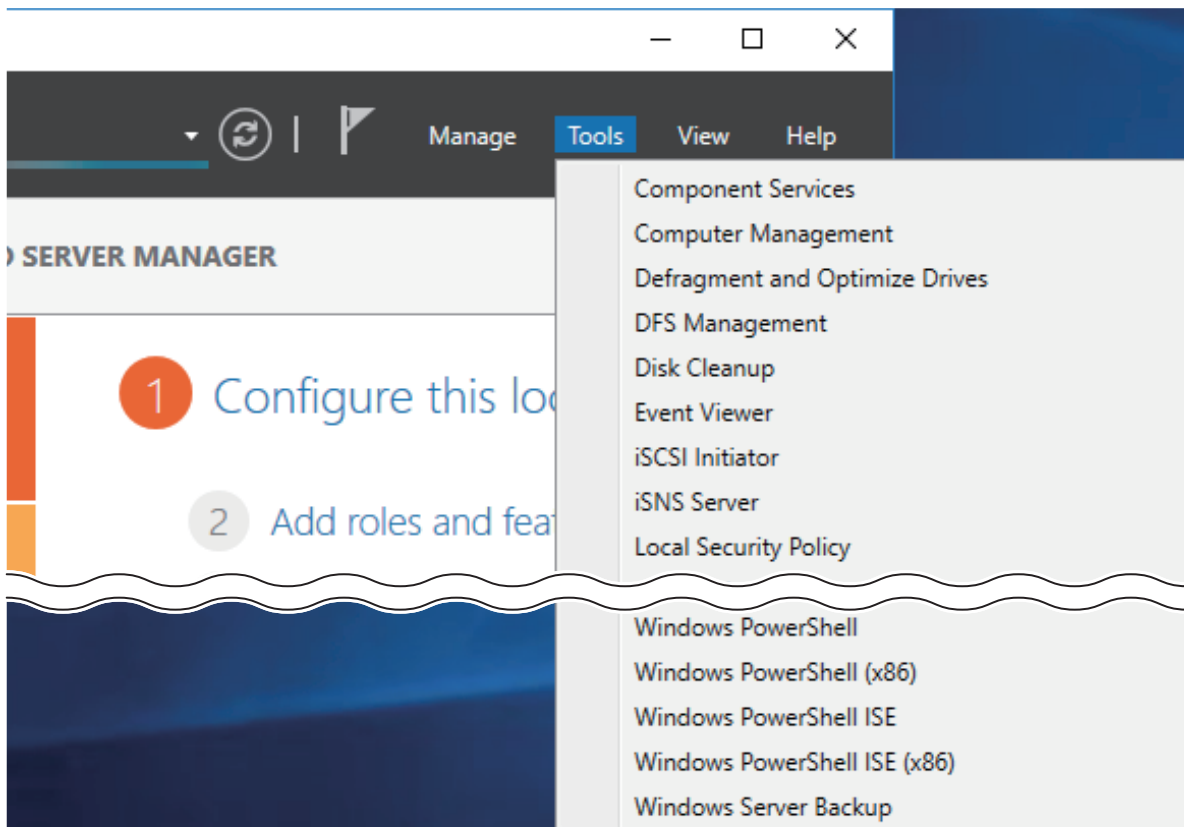

2 Click *Disk Management*.

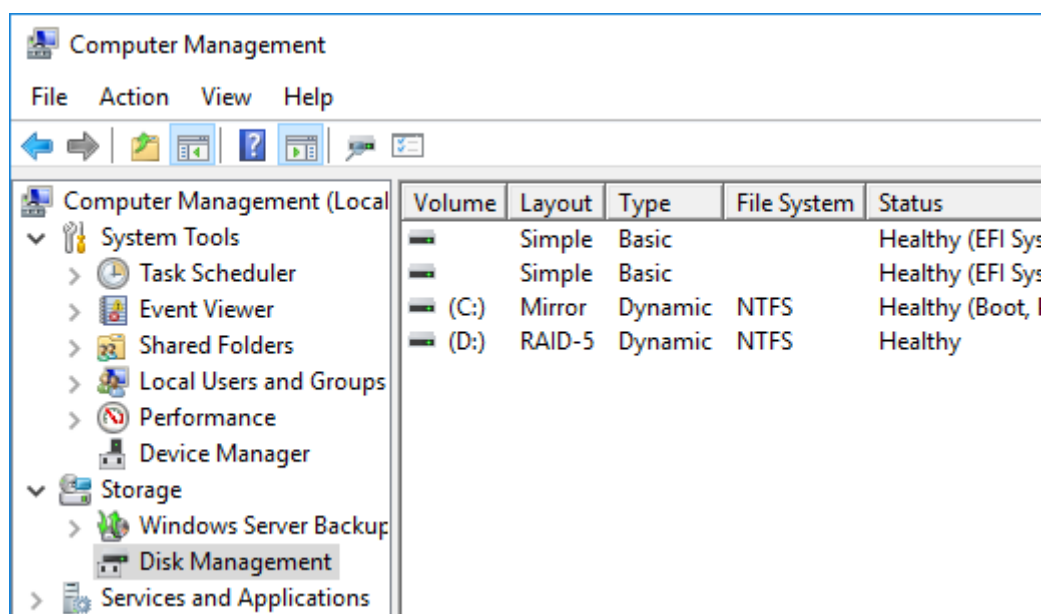

3 Right-click the volume that you want to format and select *Format*.

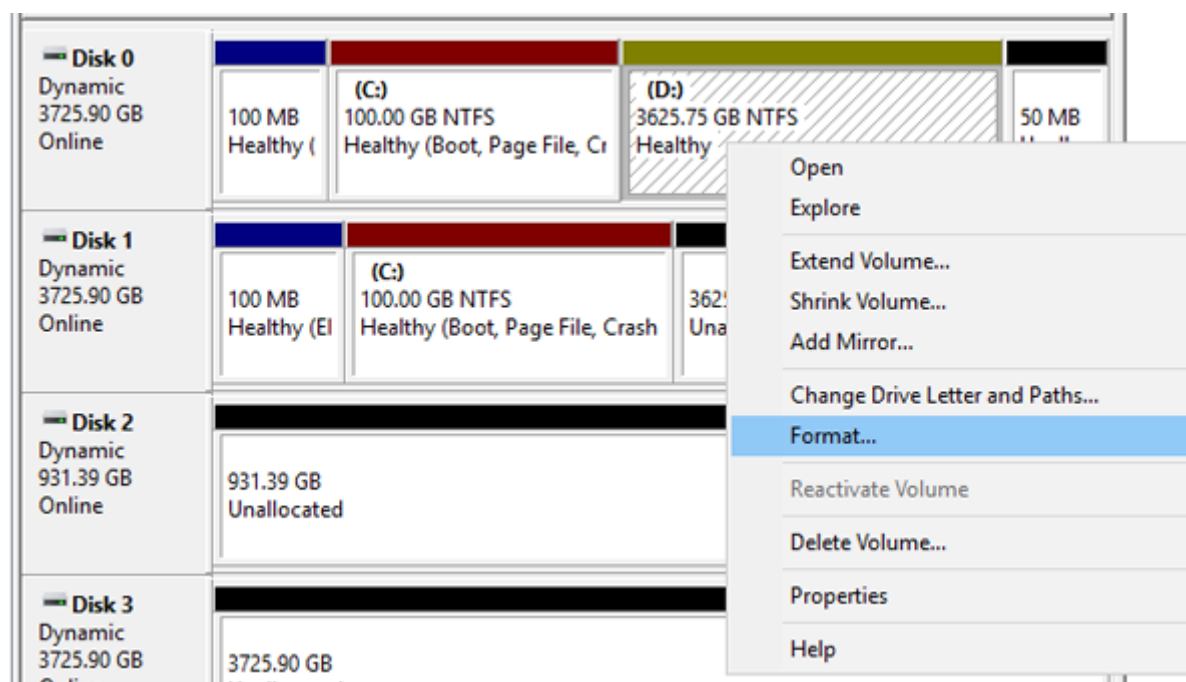

# Enabling Data Deduplication

## Installing Deduplication Role

- 1 From Server Manager, click *Dashboard > Add roles and features*.

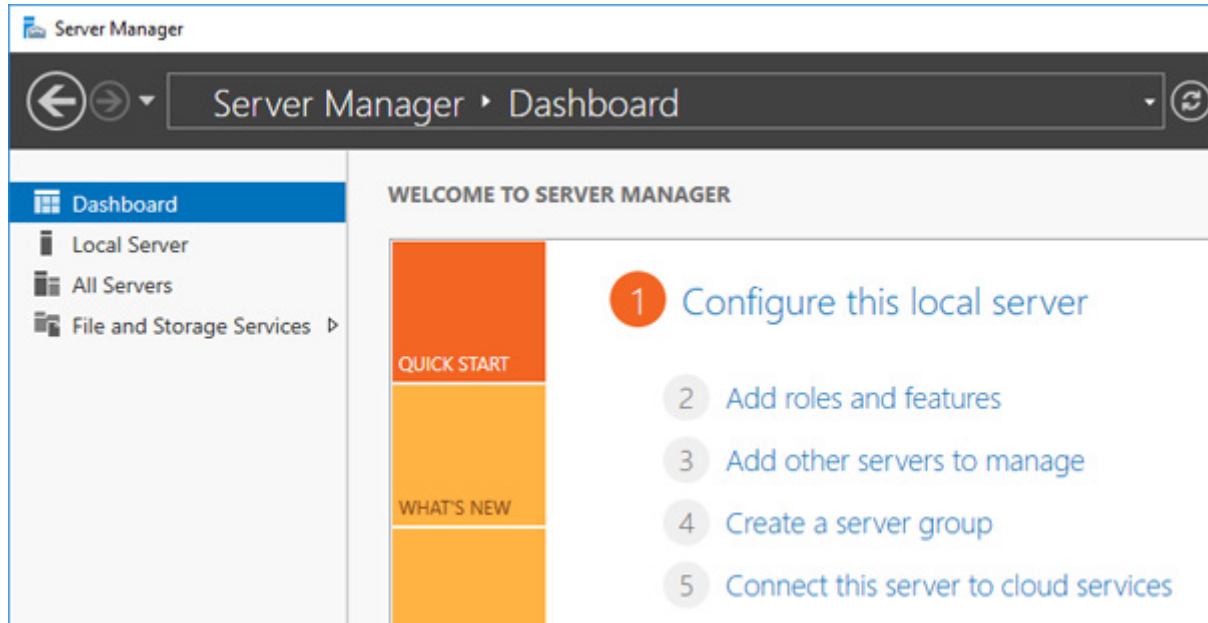

- 2 Click *Next*.

- 3 Select "Role-based or feature-based installation".

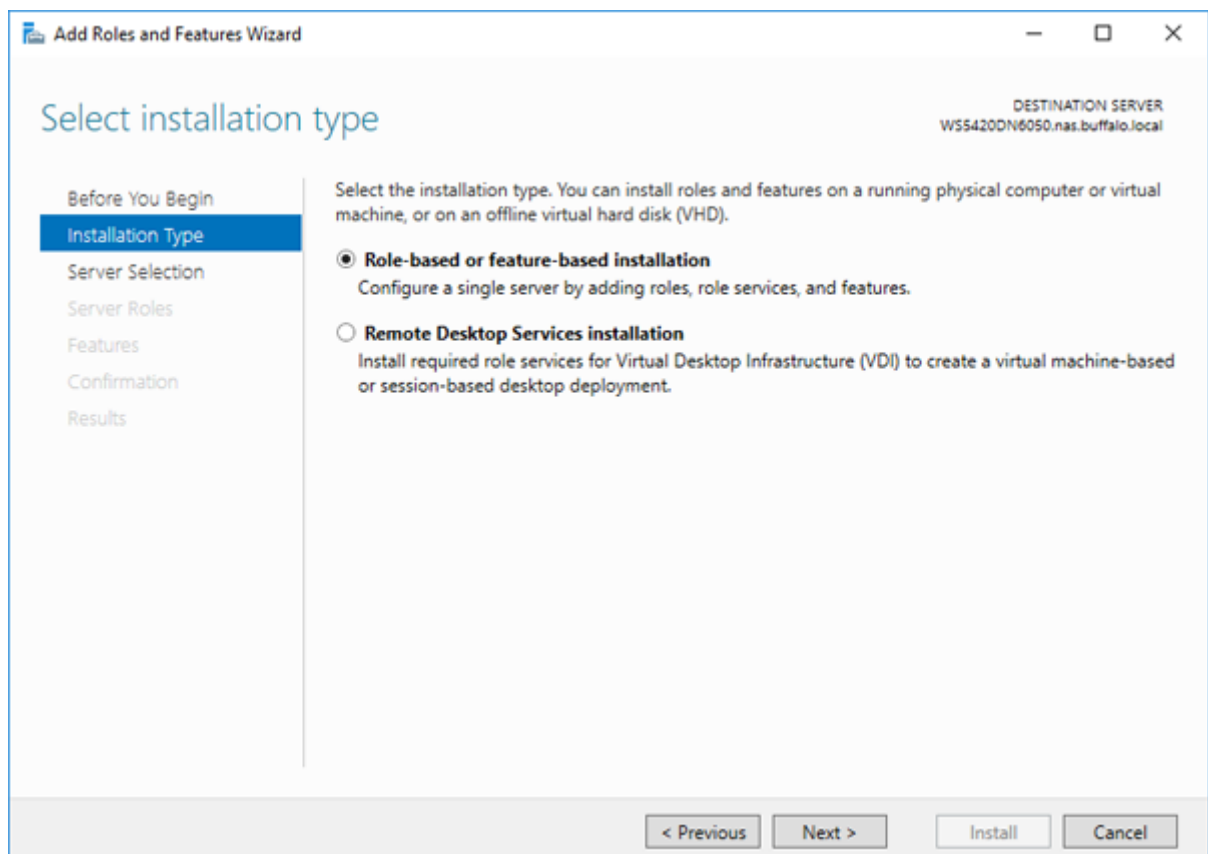



4 Click *Next*, then click *Next* again.

5 Select “Data Deduplication” under “File and Storage Services” > “File and iSCSI Services”.

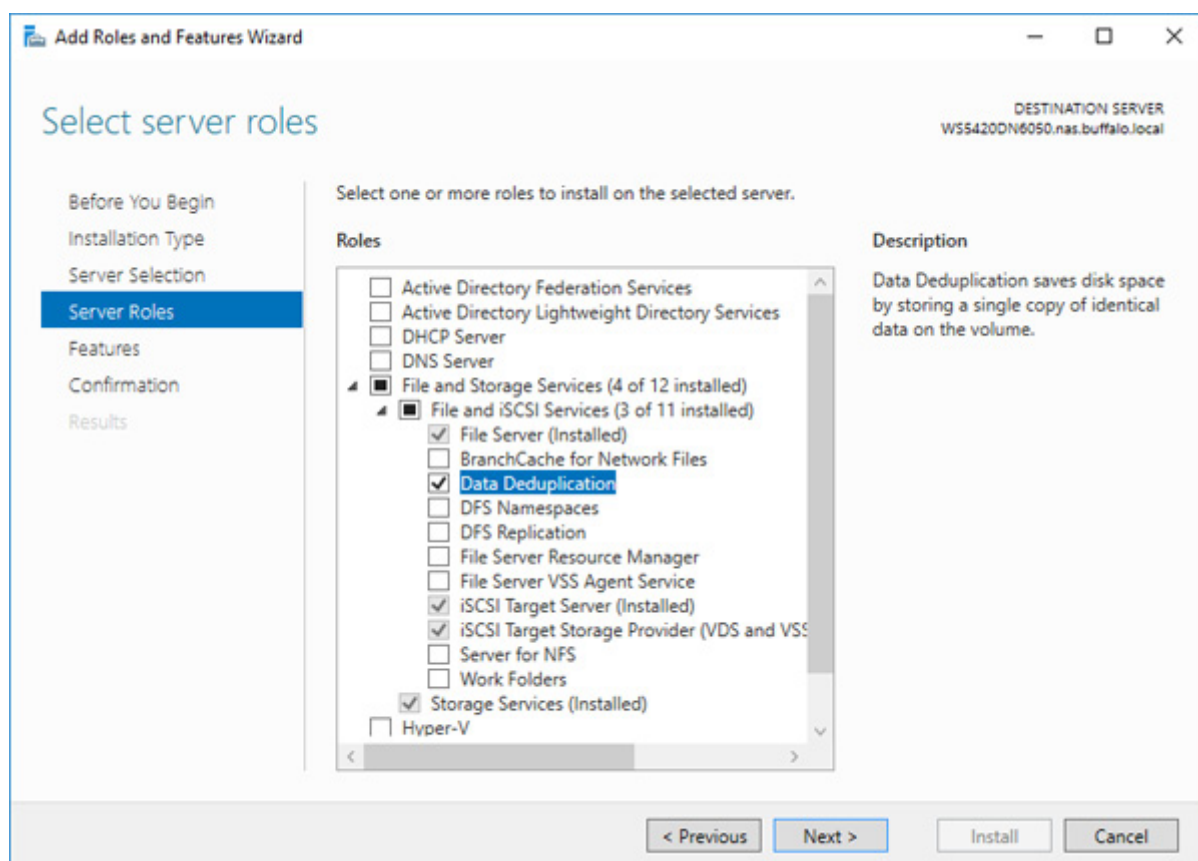

6 Click *Next* twice, then click *Install*.

7 Click *Close* to finish.

## Configuring Data Deduplication

1 From Server Manager, click *File and Storage Services*.

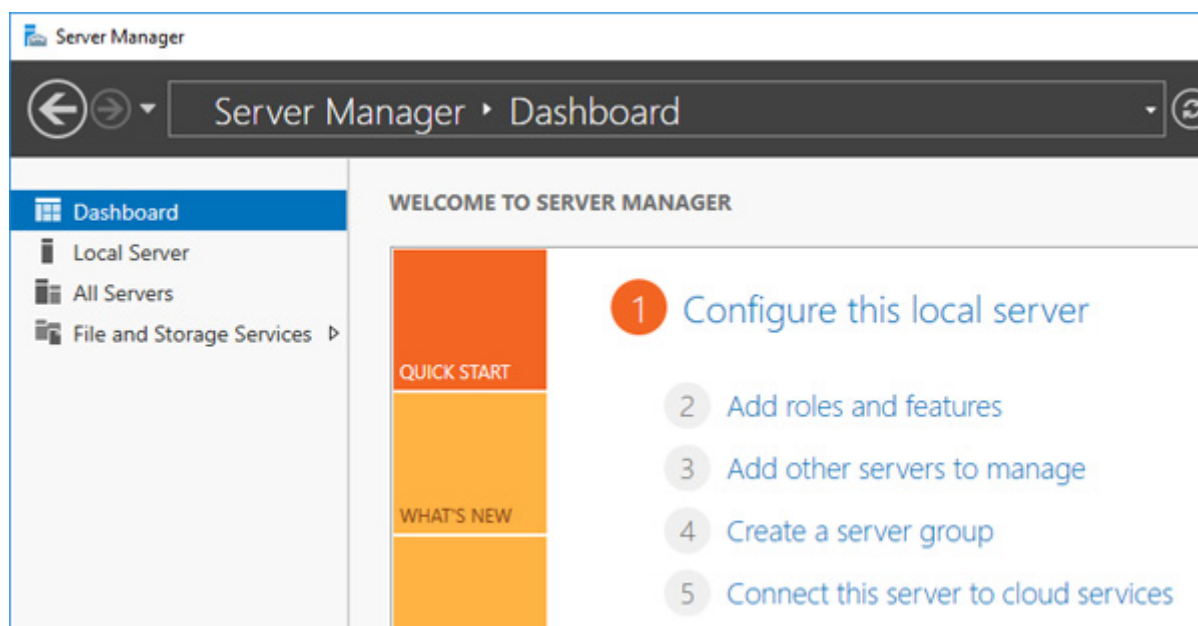

2 Click *Volumes*. Right-click the drive which will be used to configure data duplication and click *Configure Data Deduplication*.

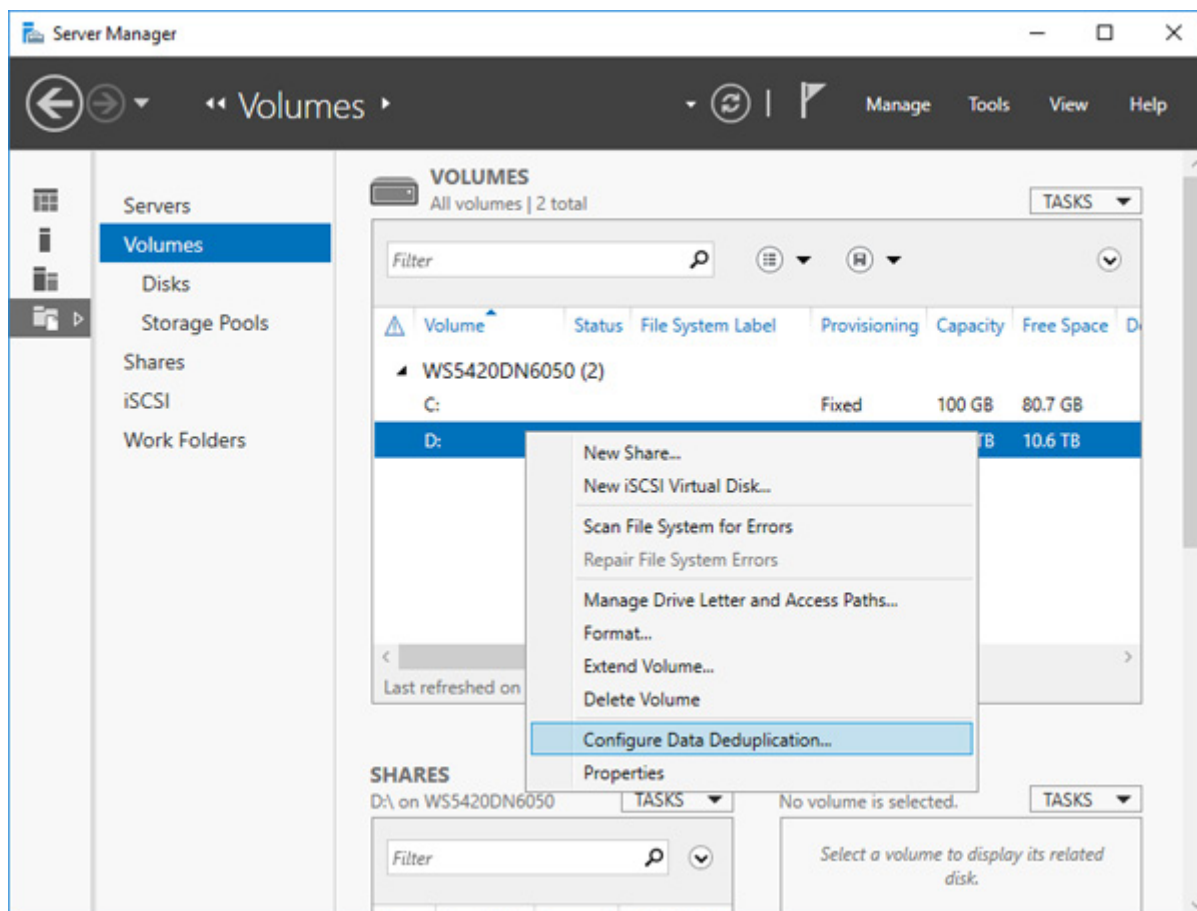

**3** Select “General purpose file server” to the right of “Data deduplication” and click *OK*.

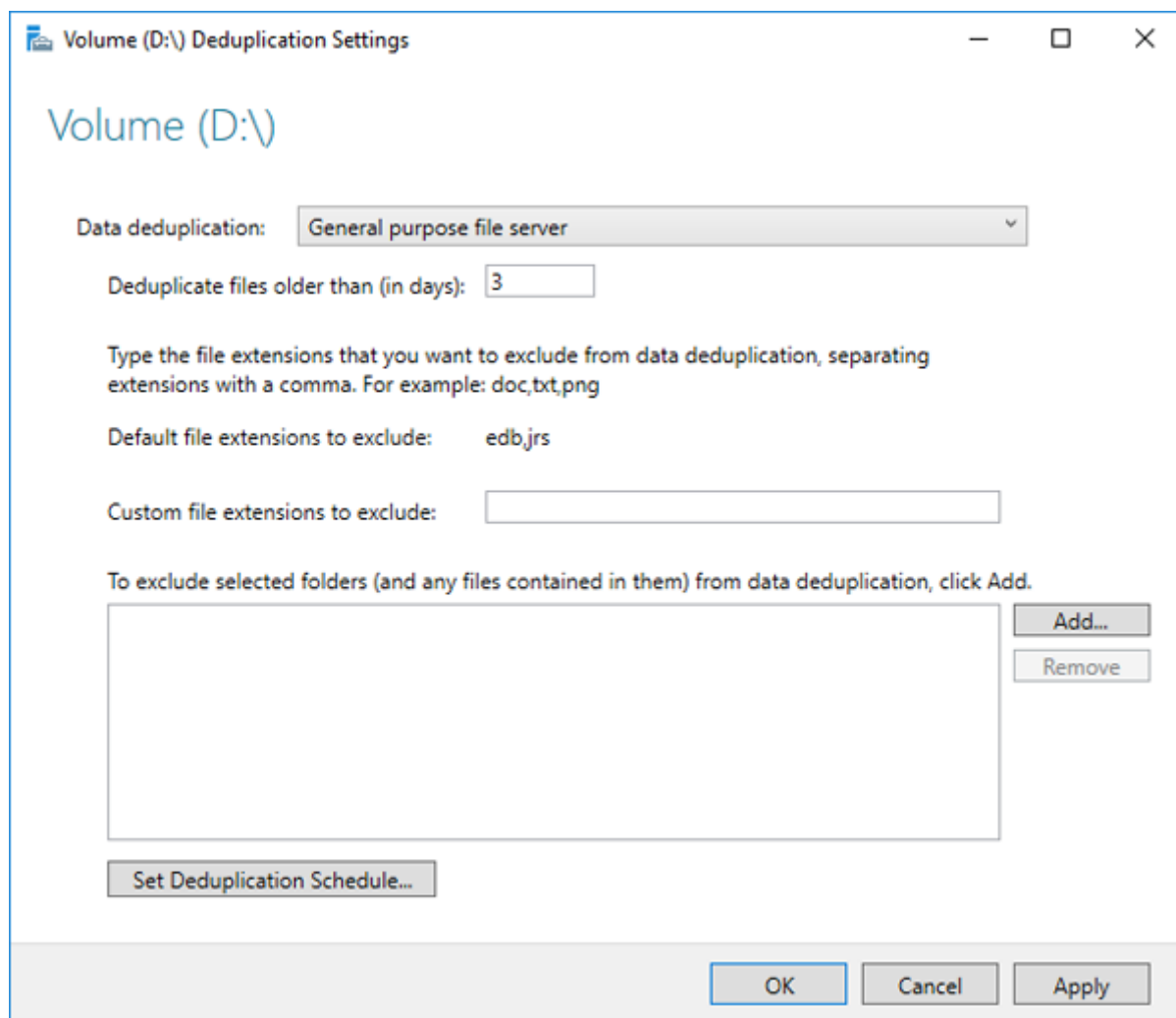

# Chapter 4 Backup and Replication

Data stored in the TeraStation may be lost through drive failure or wrong operation. To avoid losing data accidentally, back up your data regularly.

You can back up data using the following functions:

- Windows Server Backup
- Buffalo Replication
- DFS Replication

---

## Backing Up in Windows Storage Server

---

### Preparing a Backup Destination

---

Follow the procedure below to set your backup schedule.

- 1 From Server Manager, click *Tools > Windows Server Backup*. The “Windows Server Backup” wizard will start.

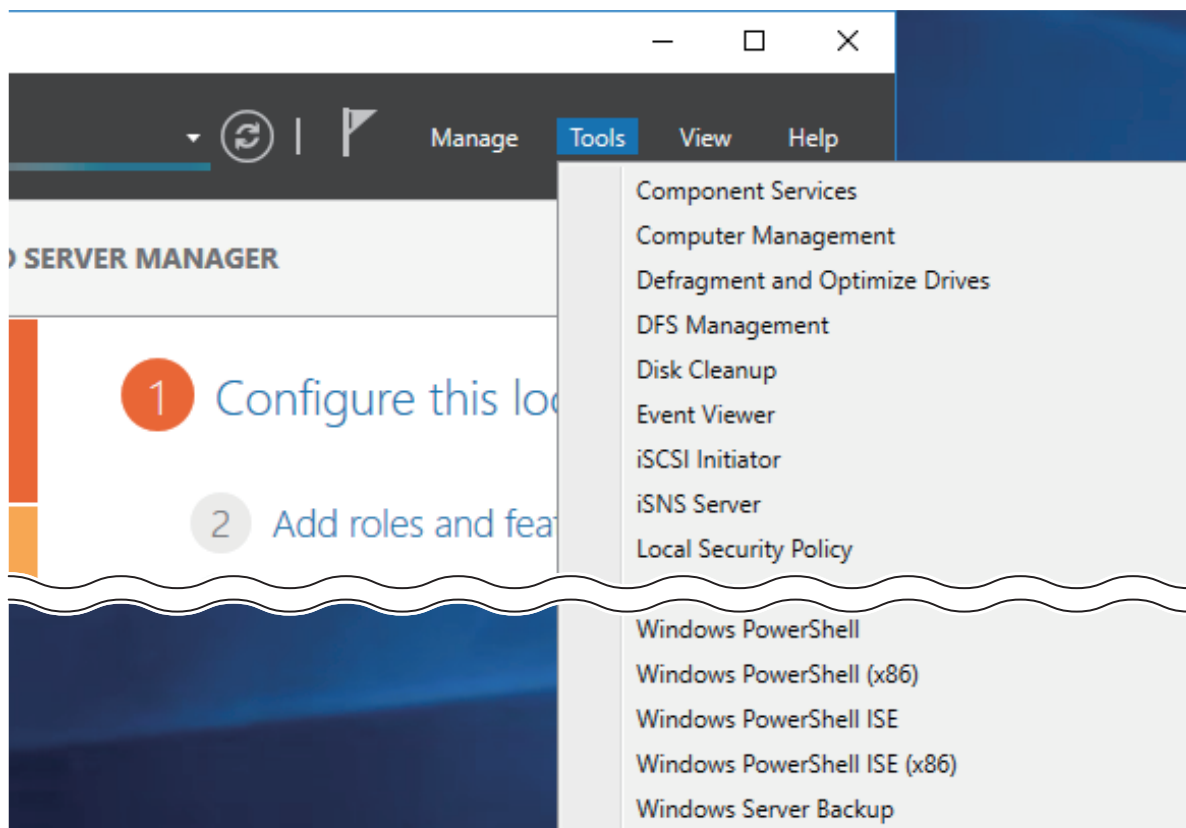

**2** Click *Local Backup*. If “Reading data; please wait...” is displayed, please wait until any messages disappear.

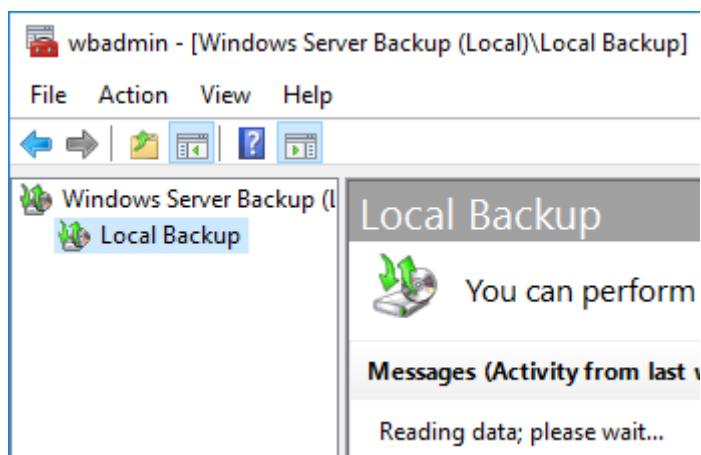

**3** Right-click on “Local Backup” and select *Backup Schedule....* The “Backup Schedule Wizard” will start.

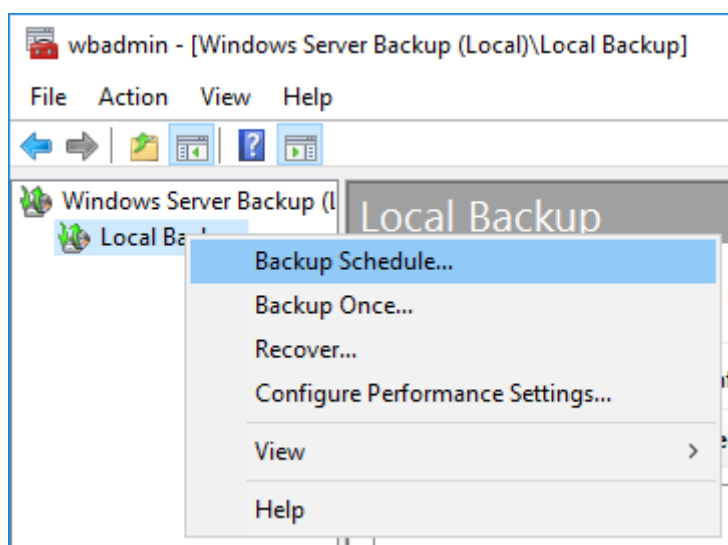

**4** Click *Next*.

5 Select "Custom" and click Next.

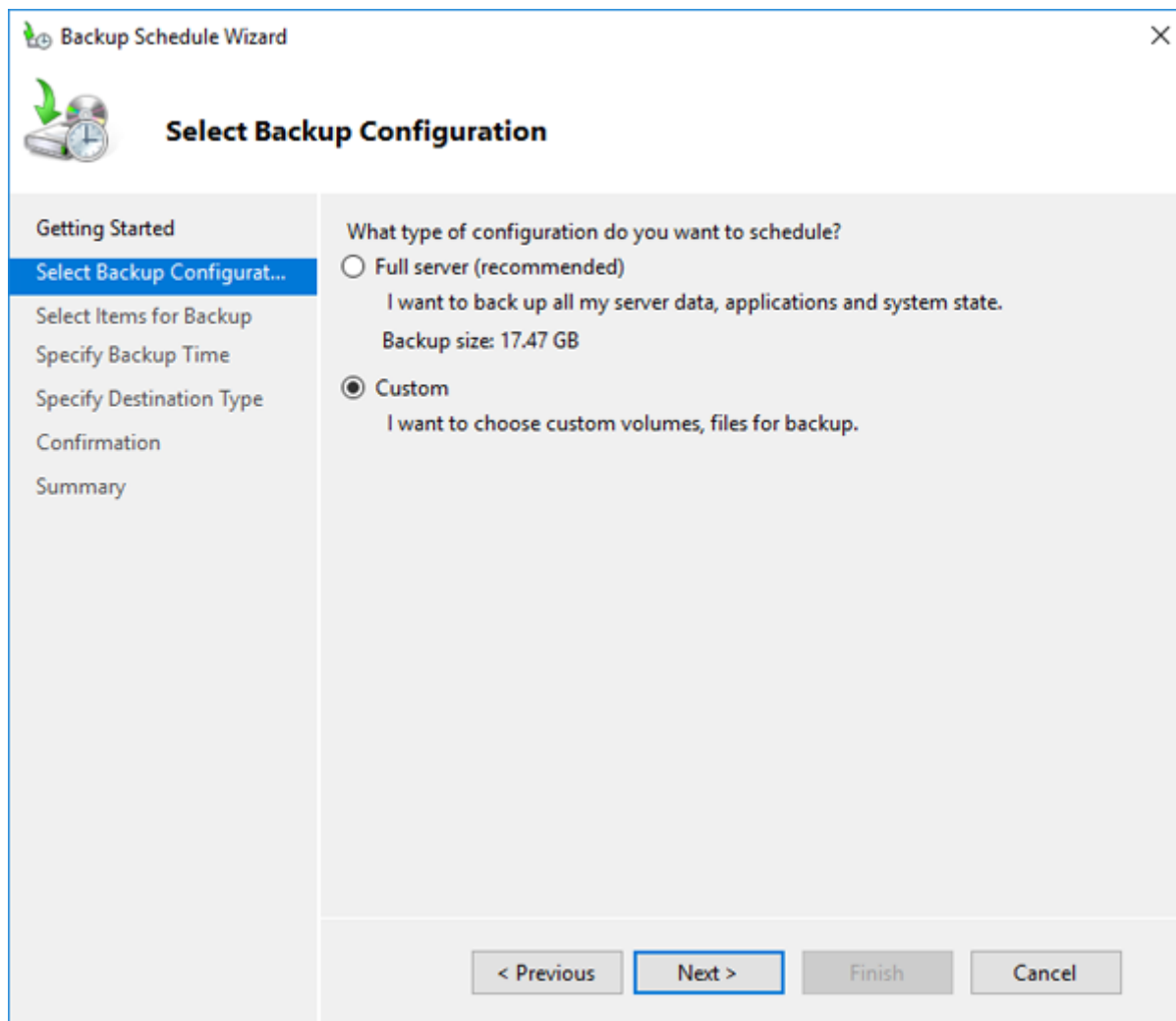

6 Click *Add Items*.

**7** Select the backup source folders or drives and click *OK*.

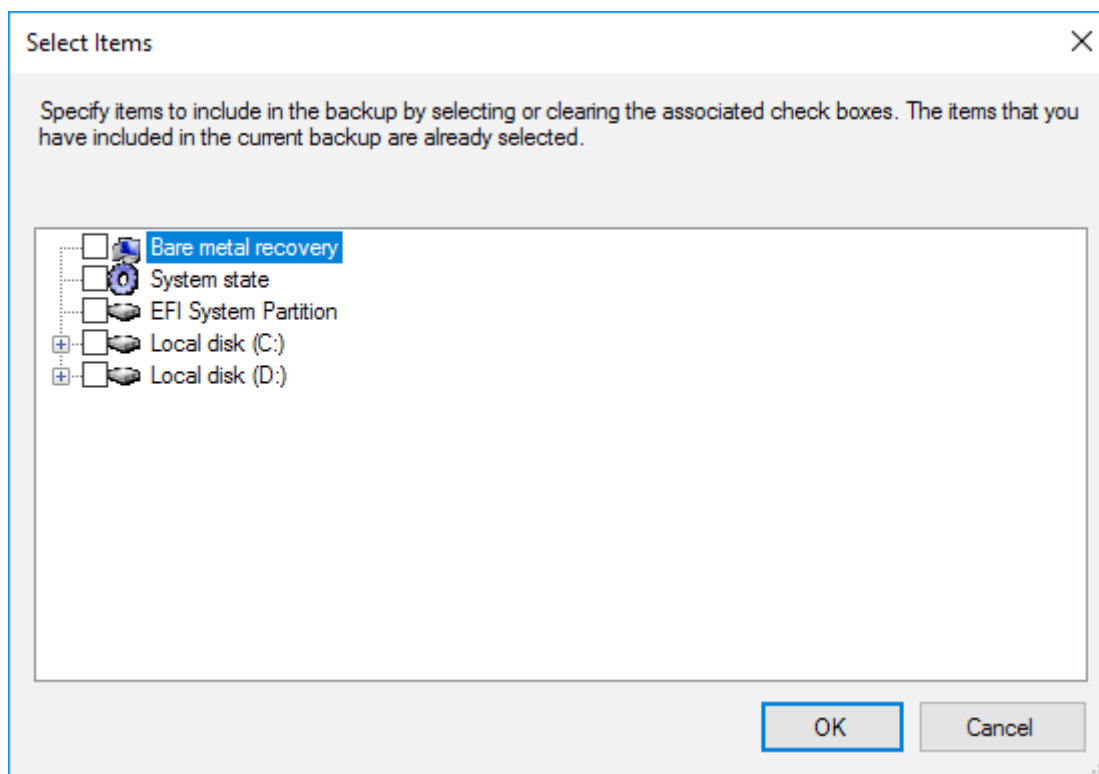

**8** Click *Next*.

9 Specify the schedule to run the backup and click *Next*.

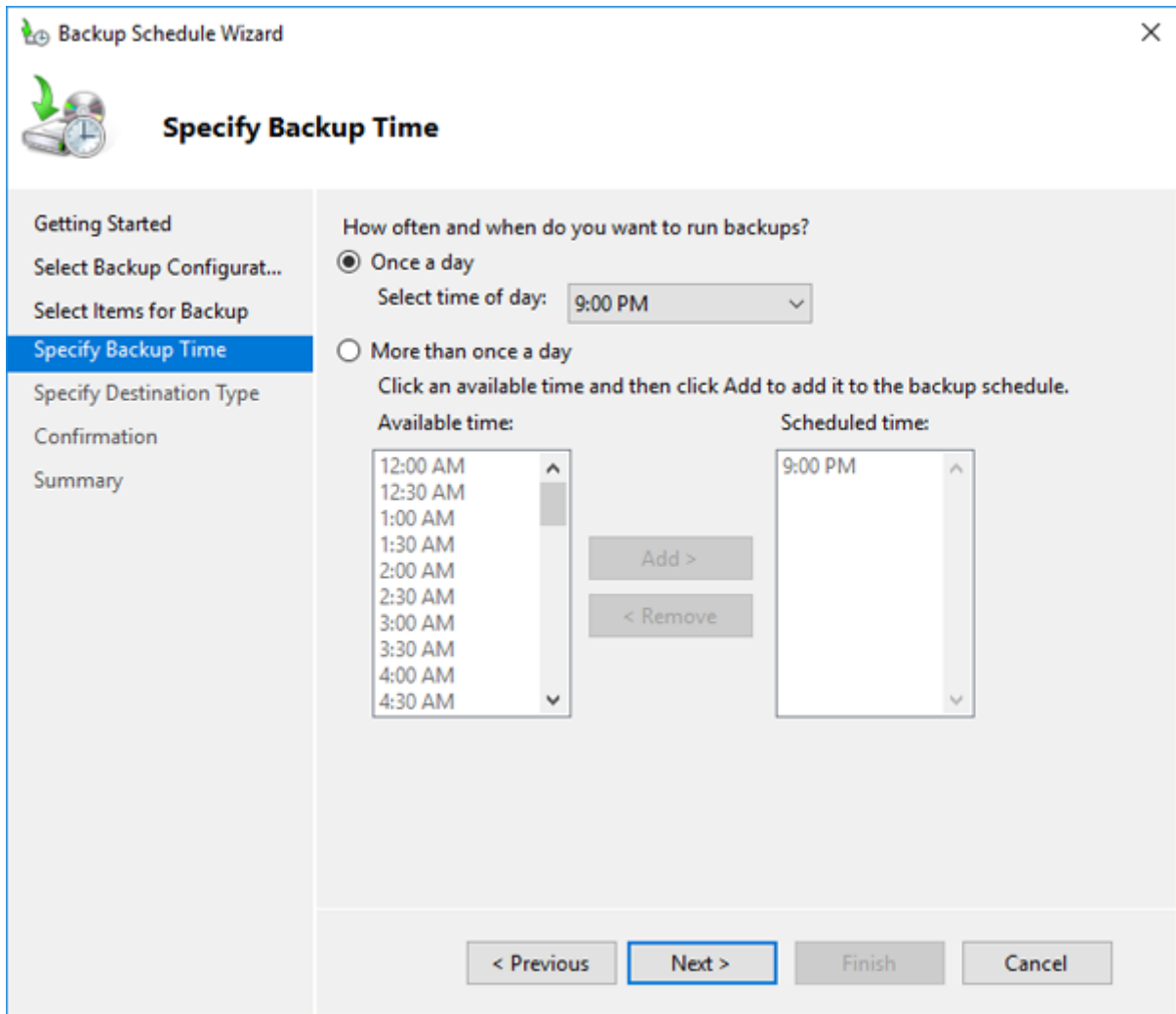



**10** Select the backup destination and click *Next*.

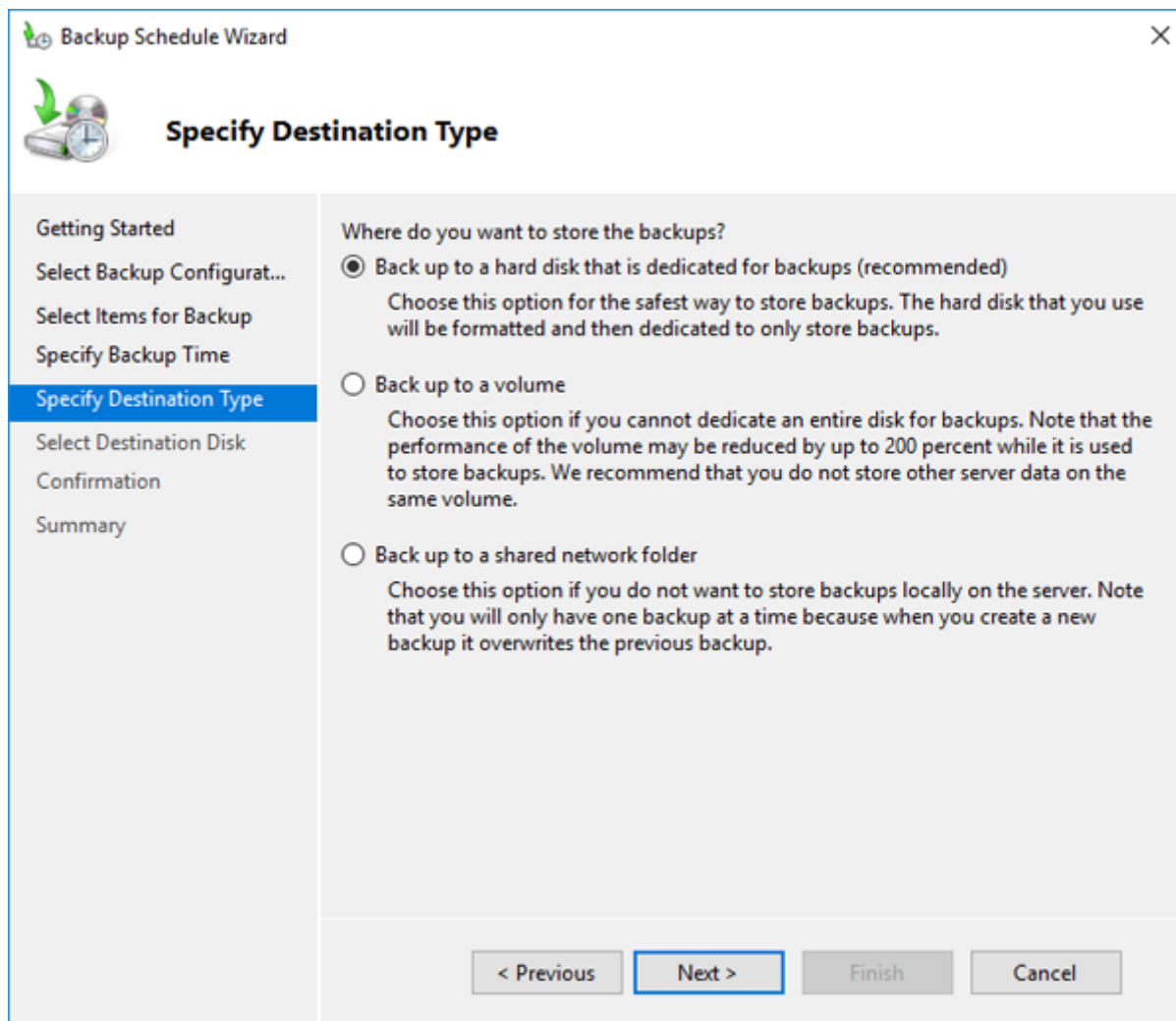

**11** Step through the wizard to finish.

## Recovering Backup Data

---

Follow the procedure below to recover the backup data to the TeraStation.

1 From Server Manager, click *Tools > Windows Server Backup*. The “Windows Server Backup” wizard will start.

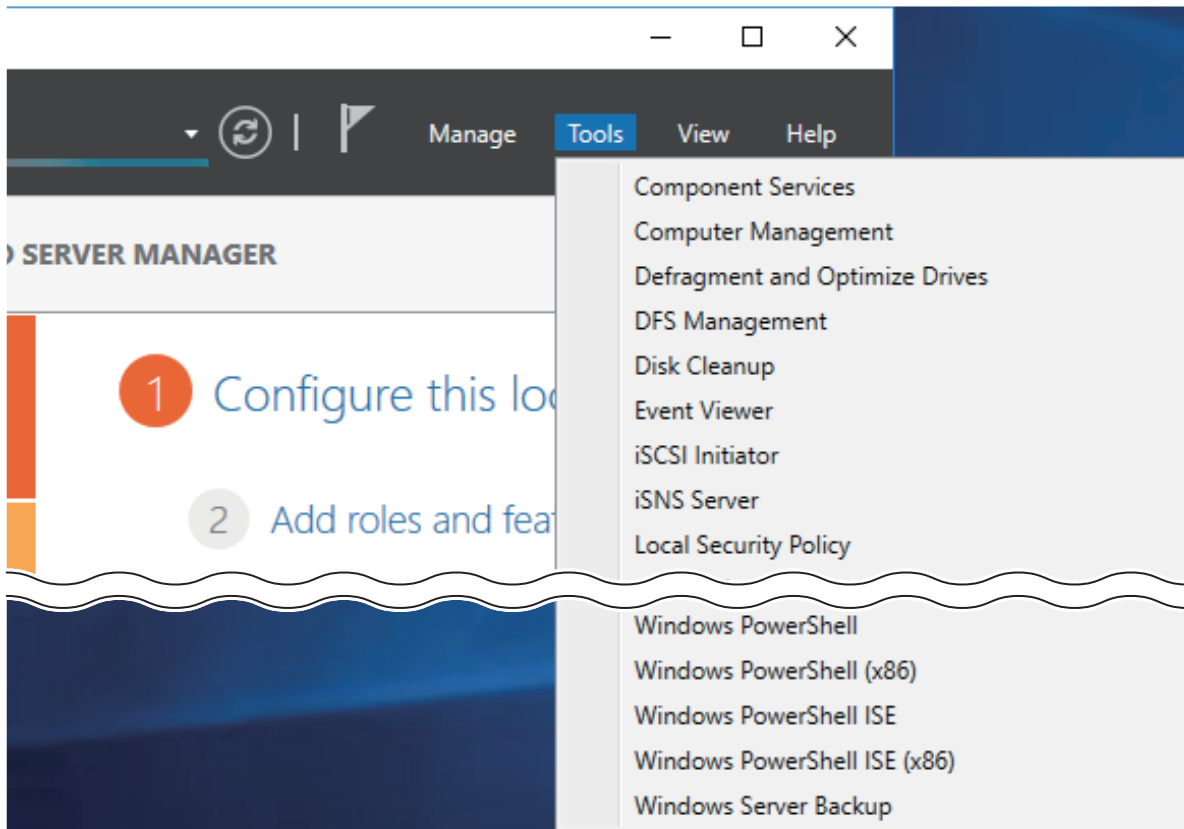

2 Click *Local Backup*. If “Reading data; please wait...” is displayed, please wait until any messages disappear.

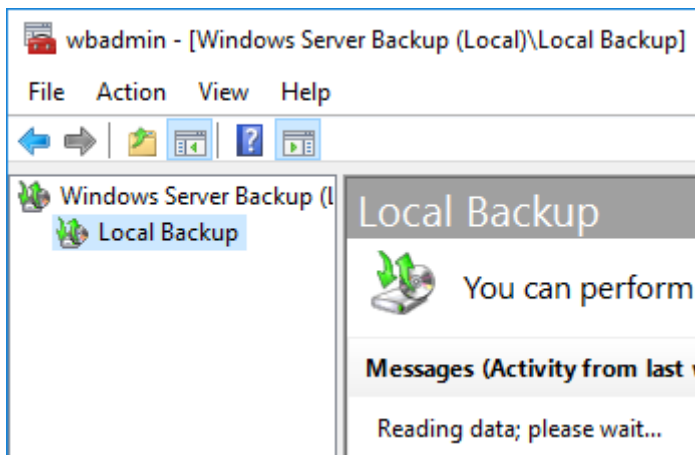

3 Right-click on "Local Backup" and click *Recover...*. The recovery wizard will start.

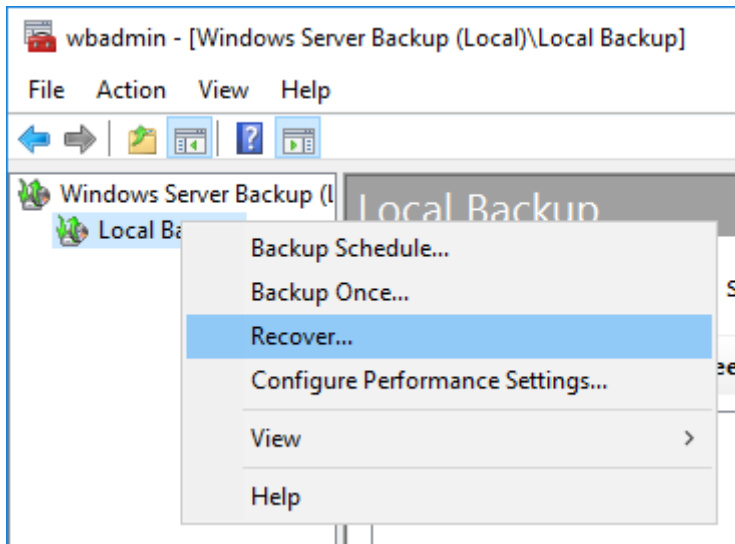

4 Select where the backup data is saved and click *Next*. When "A backup stored on another location" is selected, specify the folder of the backup data in the next page.

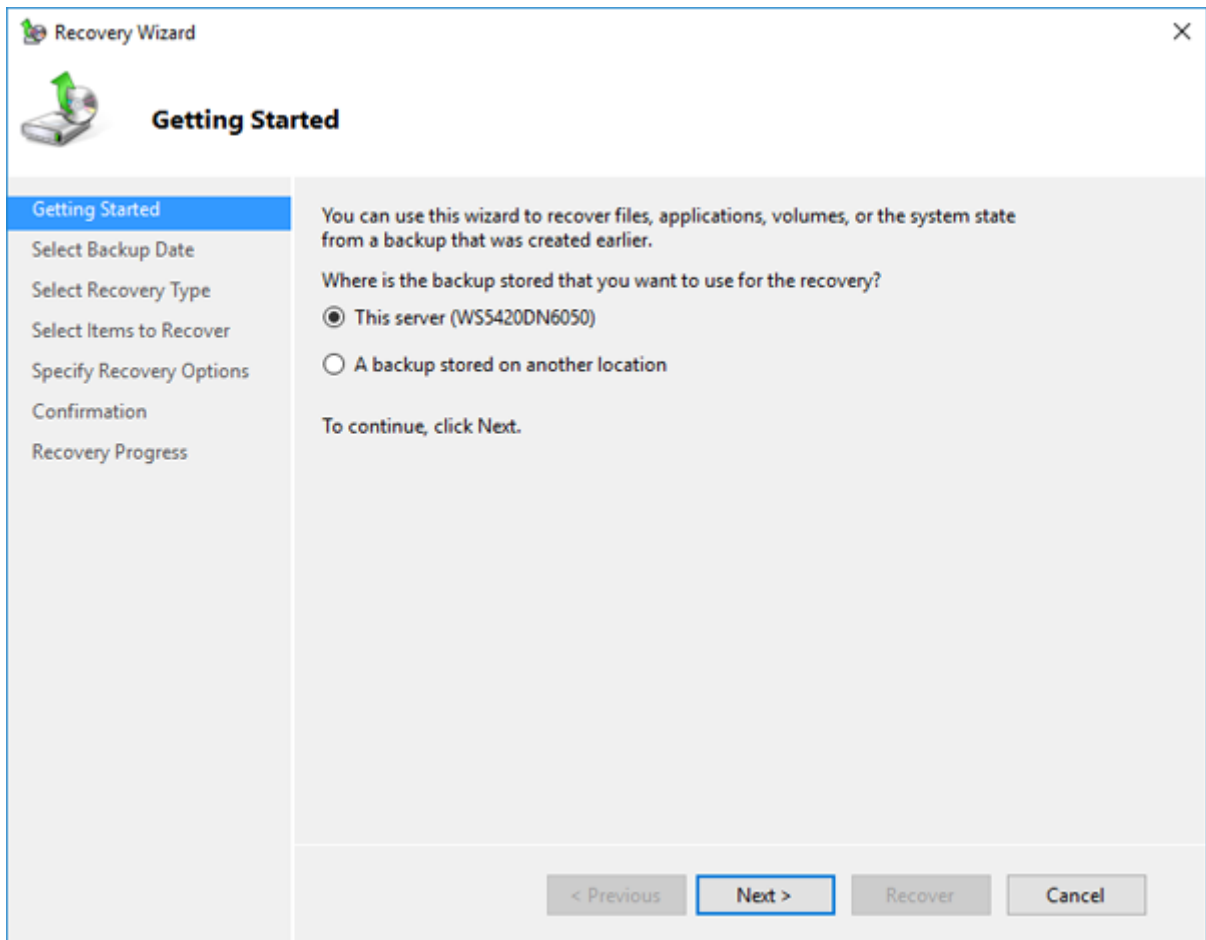

5 Select the date when a data backup occurred and click *Next*.

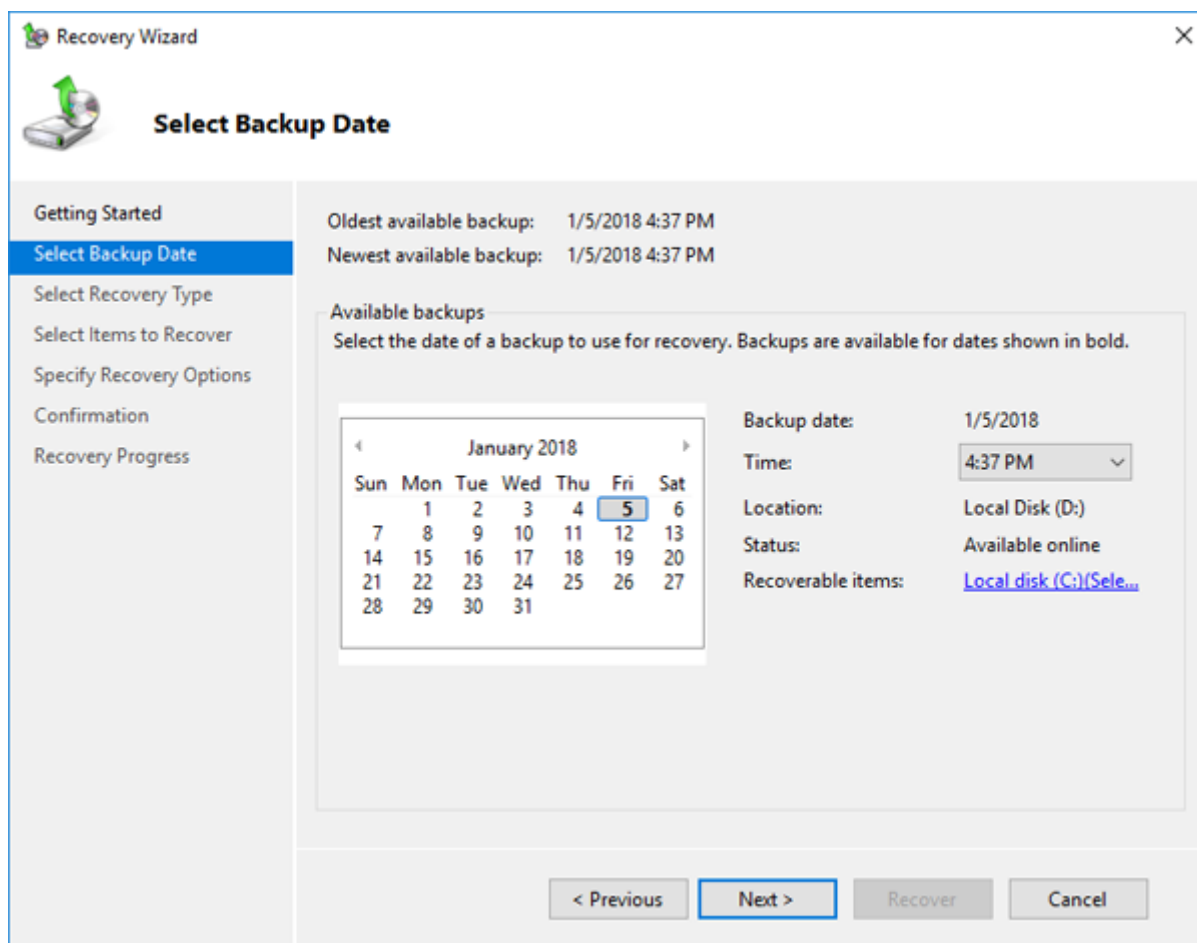

6 Select the recovery targets and click *Next*.

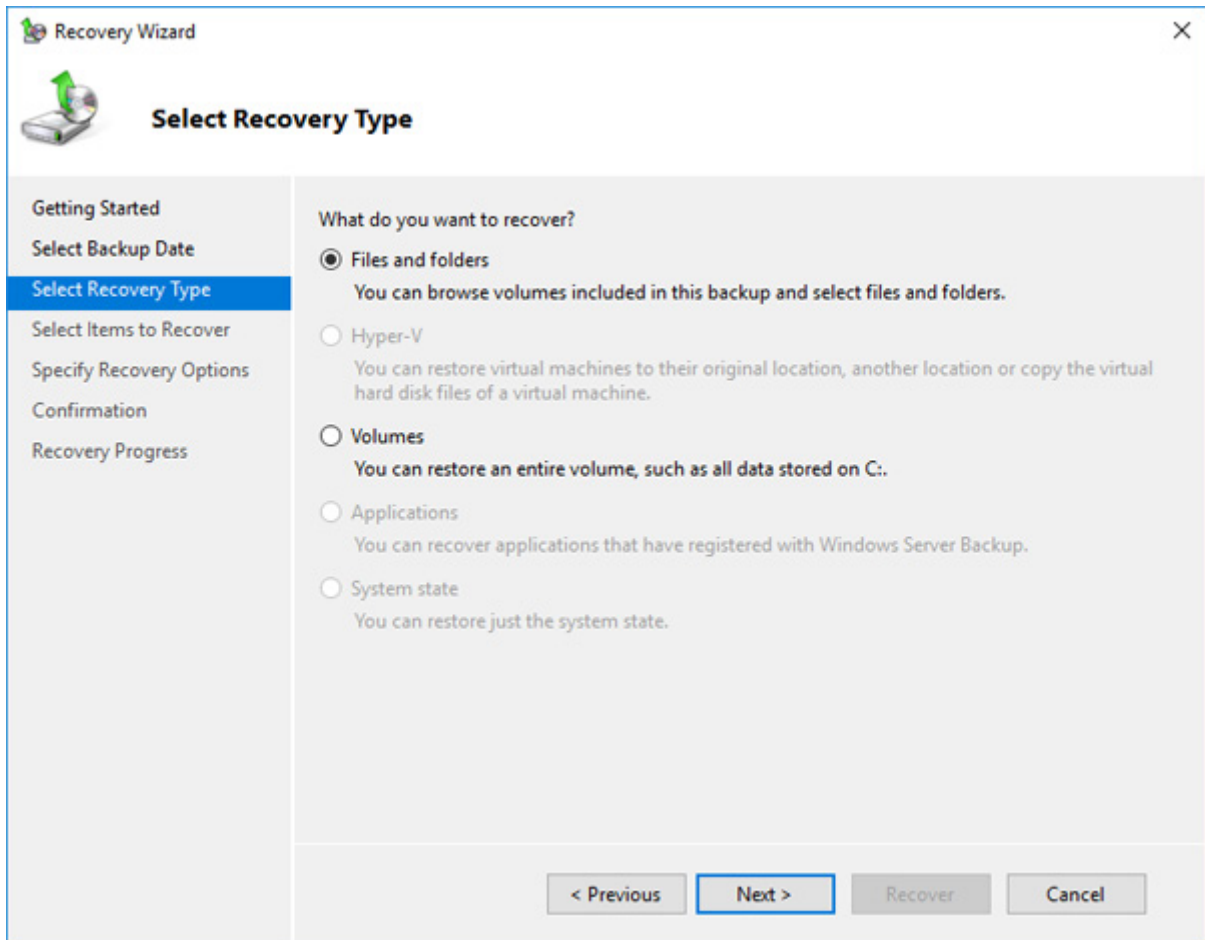

7 Step through the wizard to finish.

---

## Configuring Replication

---

Replication copies all data from a share to a share on a different TeraStation. This is an easy way to configure a reliable system to provide data protection in the event your main TeraStation fails. To configure replication, connect an Ethernet cable to the LAN port of each TeraStation and follow the steps below.

**Note:** The replication operation may not proceed properly if a large number of files or a large capacity file have been replicated continually for a long time, causing too large of a data load. Before starting replication, check if there are any possible pauses for operational issues.

## Differences Between Buffalo Replication and DFS Replication

---

### Buffalo Replication

- One-way replication (from the TeraStation to another device)
- Another Buffalo NAS devices can easily be configured for the replication destinations.

### DFS Replication

- Two-way replication
- The Active Directory domain environment is required and the TeraStation should be joined to the domain.

If your environment must join the Active Directory domain, use DFS Replication. If joining the Active Directory is not required, or if a TeraStation or LinkStation has been configured as the replication destination, using Buffalo Replication is recommended.

## Before Using Replication

- For best results, use static IP addresses with the same subnet masks for both replication TeraStations (source and destination). If on a VPN network, configure the network settings so that broadcast packets are not dropped.
- Setting the TeraStation on a 1000 Mbps or faster network is recommended.
- Up to five replication tasks can be created.
- Filenames and file paths that will be copied by replication should be within 170 characters. Files with filenames that are longer than 170 characters may not be copied correctly.

## Buffalo Replication

If using Buffalo Windows Storage Server-installed TeraStations as both the replication source and destination, start from step 1. If using a different TeraStation as the replication destination, refer to that TeraStation's user manual to configure it as a replication destination. After you finish configuring on the TeraStation's Settings, go to step 3.

**1** Click *TeraStation Backup & Replication Folder Settings* in the Start menu on the replication destination TeraStation's Windows Storage Server.

**2** Click the blank space under "Label" and enter a label for the folder. Click  under "Folder" and select the folder as a replication destination. Enter the desired characters for a backup device access key and click *Save* when finished.

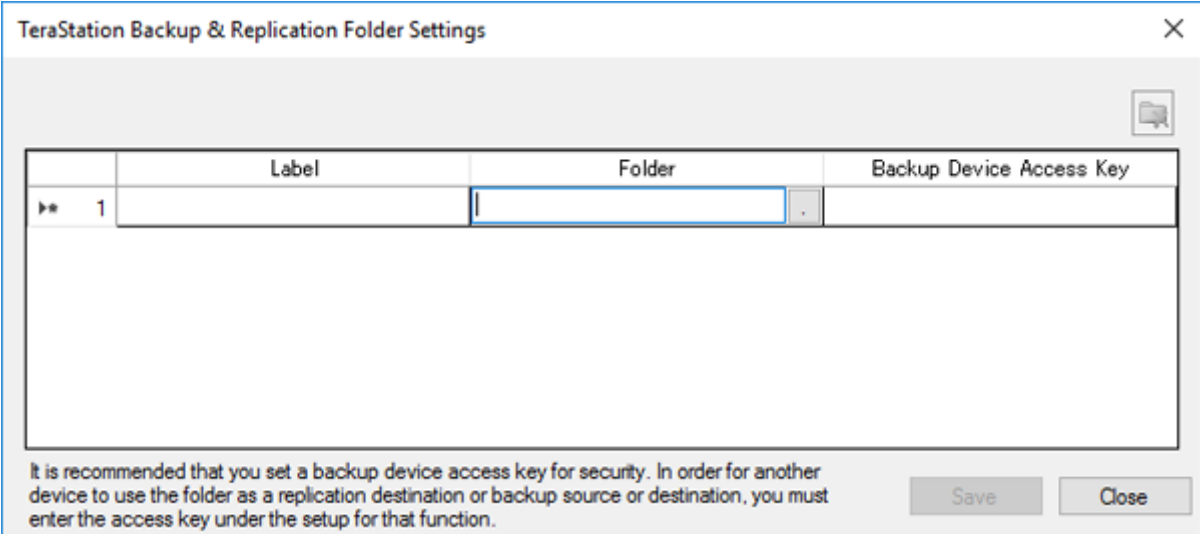

	Label	Folder	Backup Device Access Key
▶▶ 1			

It is recommended that you set a backup device access key for security. In order for another device to use the folder as a replication destination or backup source or destination, you must enter the access key under the setup for that function.

Save Close

**3** Click *Buffalo Replication* in the Start menu on the replication source TeraStation's Windows Storage Server.

- 4 Click the blank space under “Replication Source”, click , and select a folder from the list as the replication source folder, then click *OK*.

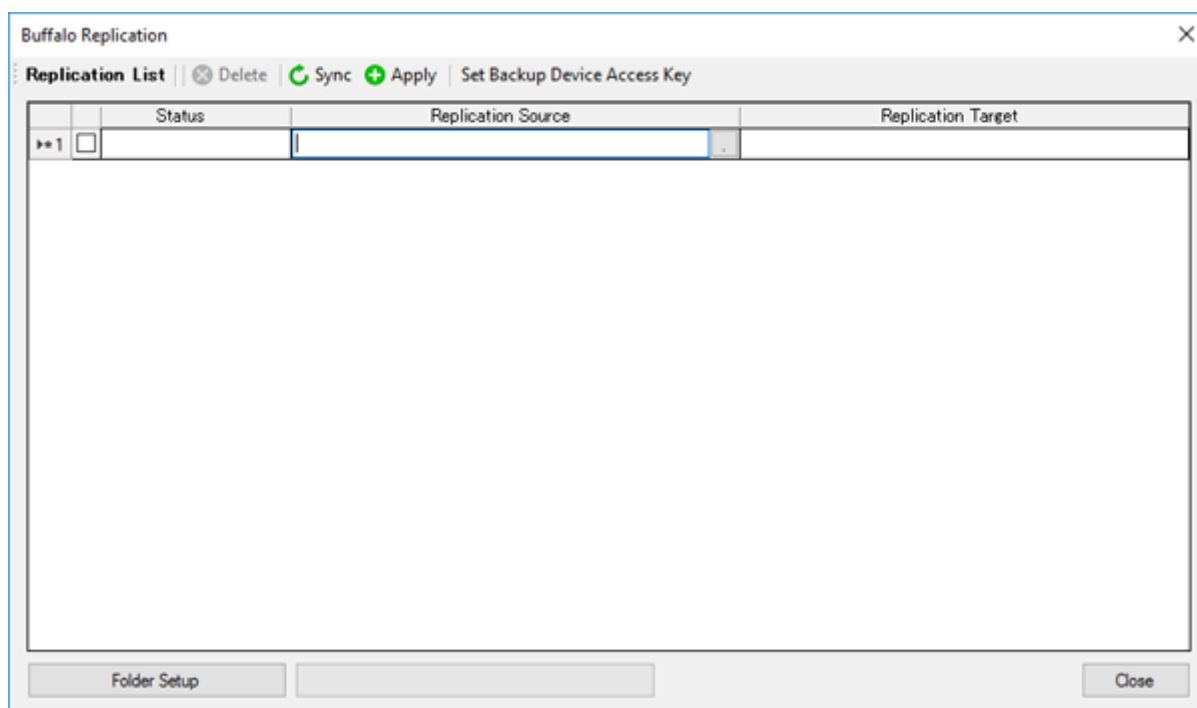

- 5 If you had configured a backup device access key to the replication destination folder, click *Set Backup Device Access Key*. If you didn't, skip to step 7.

- 6 Enter the configured backup device access key of the replication destination folder and click *OK*.

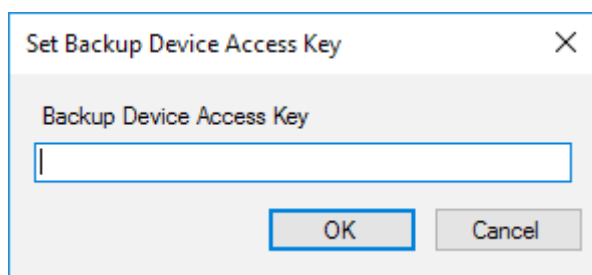

- 7 Click the blank space under “Replication Target” and select the folder, then click *Select* from a folder list. If no shared folders appear, click *Refresh* and try again.

To configure folders on the device that is located on another network, click *Add* and enter the IP address of the device, then click *Save*. After the IP address is added to the list, click *Refresh* again to add the folder to the list of folders.

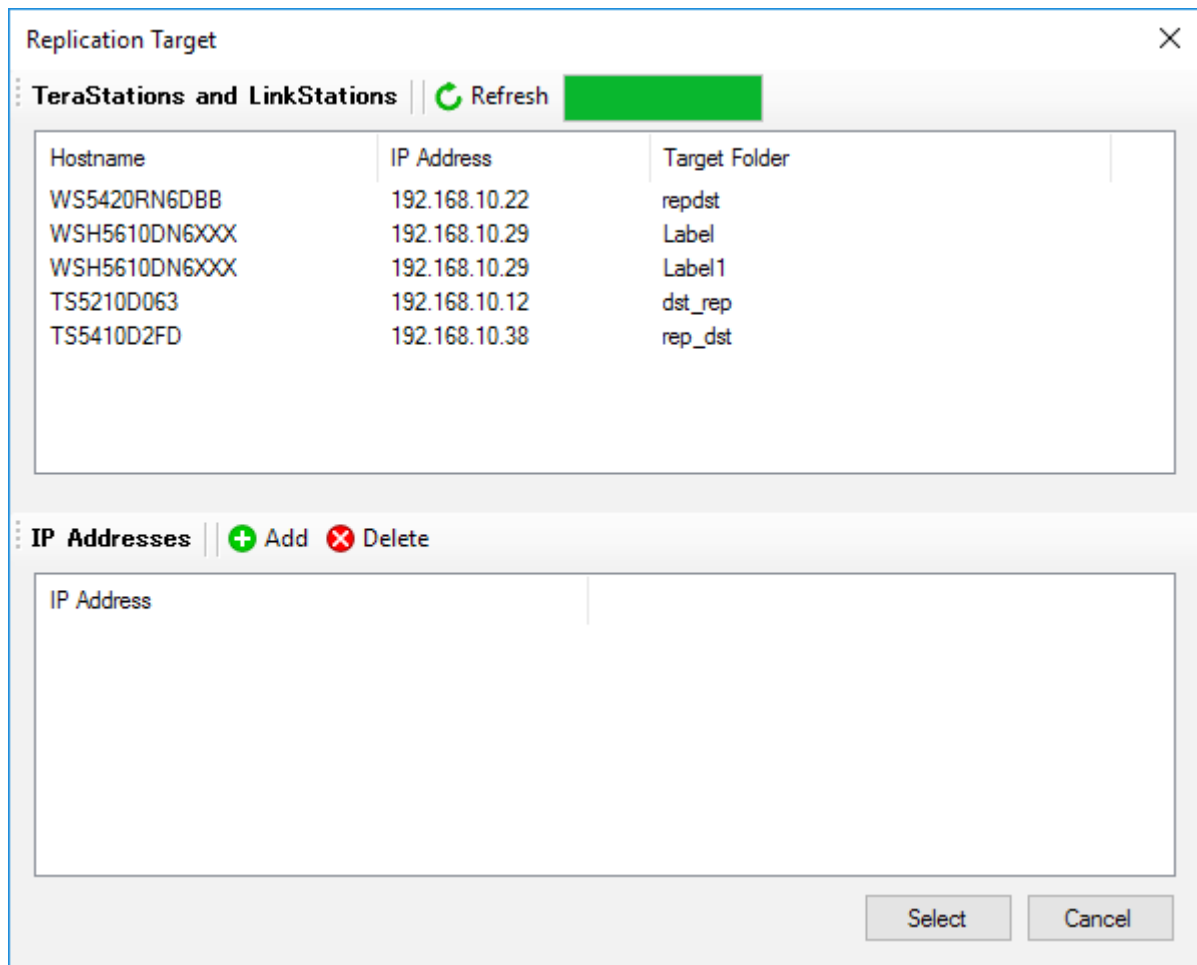

8 When finished configuring, click *Apply*.

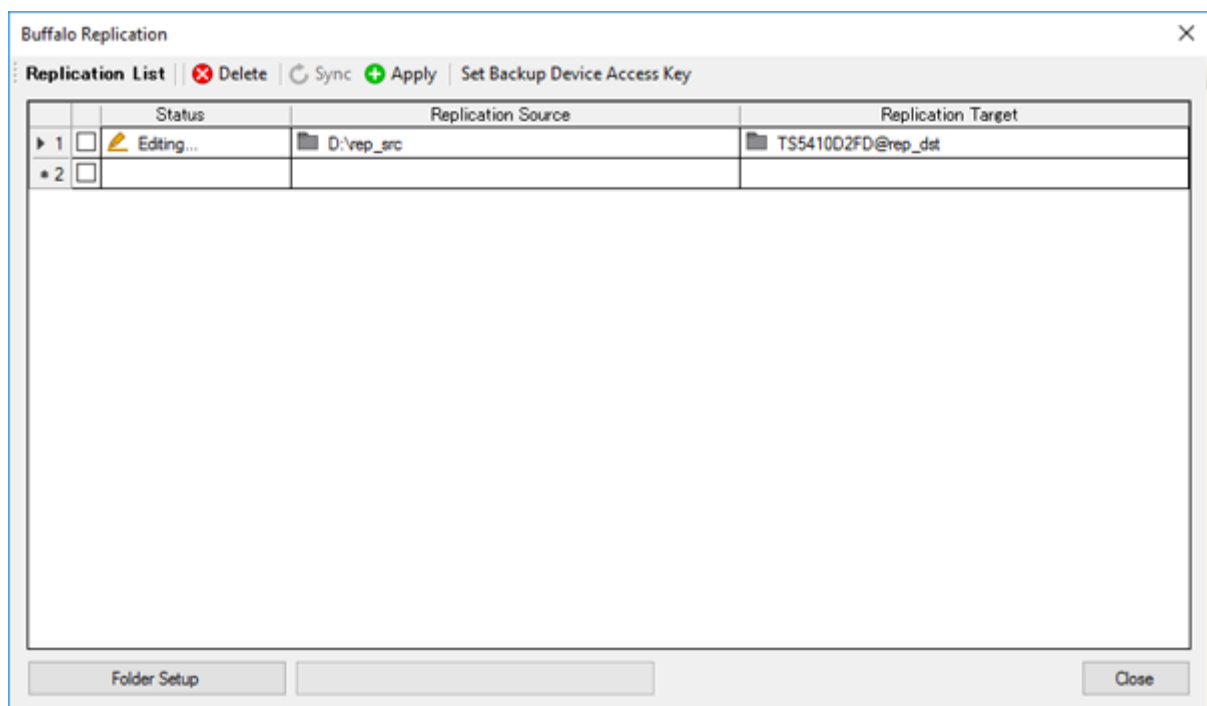



**9** Click *OK*. The task will start a full backup from the replication source data to the replication destination after deleting existing files in the replication destination.

**Notes:**

- To delete the settings from the list, select the task and click *Delete*.
- The Ethernet port number to use for replication cannot be specified in the replication task.
- The following files and folders will not be replicated:  
Files with periods (.) or underscores (\_) as the first character in their name.  
Folders with periods (.) or underscores (\_) as the first character in their name.  
.AppleDesktop/  
Network Trash Folder/  
TheVolumeSeHngsFolder/  
.DS\_Store/  
.AppleDouble/  
.AppleDB/

## If the Network Settings Are Changed After Replication Tasks Are Created

If the network settings are changed after replication tasks are created, the TeraStation cannot communicate with the replication destination TeraStation and replication may fail. For example, disconnecting the Ethernet cable and reconnecting it to another LAN port or changing the IP address of the replication source or destination TeraStation. If the network settings are changed, refresh the list of TeraStations and LinkStations as follows.

- 1** Click *Buffalo Replication* in the Start menu on Windows Storage Server.
- 2** Click *Refresh* and refresh the detected TeraStations and LinkStations list.
- 3** When the TeraStation that the network settings were changed is displayed in the refreshed list, close the window and click *Sync*.

## DFS Replication

---

DFS (Distributed File System) is a set of client and server services that allows Windows users to organize many distributed SMB file shares into a distributed file system.

To use DFS Replication, the TeraStation must be joined to an Active Directory domain. Make the necessary settings as detailed below to use DFS Replication on Windows Storage Server.

This section uses the following environment parameters as an example:

Replication Source: "WS5420DN6050"

Replication Destination: "Server-A"

Namespace Server: "WS5420DN6050"

Namespace Name: "Public"

Namespace Folder: "buffalo-share"

Replication Group: "Buffalo\_DFS"

Replication Source Folder: "D:\rep\_src"

Replication Destination Folder: "D:\rep\_dst"

## Joining an Active Directory

- 1 From Server Manager, click *Local Server*.

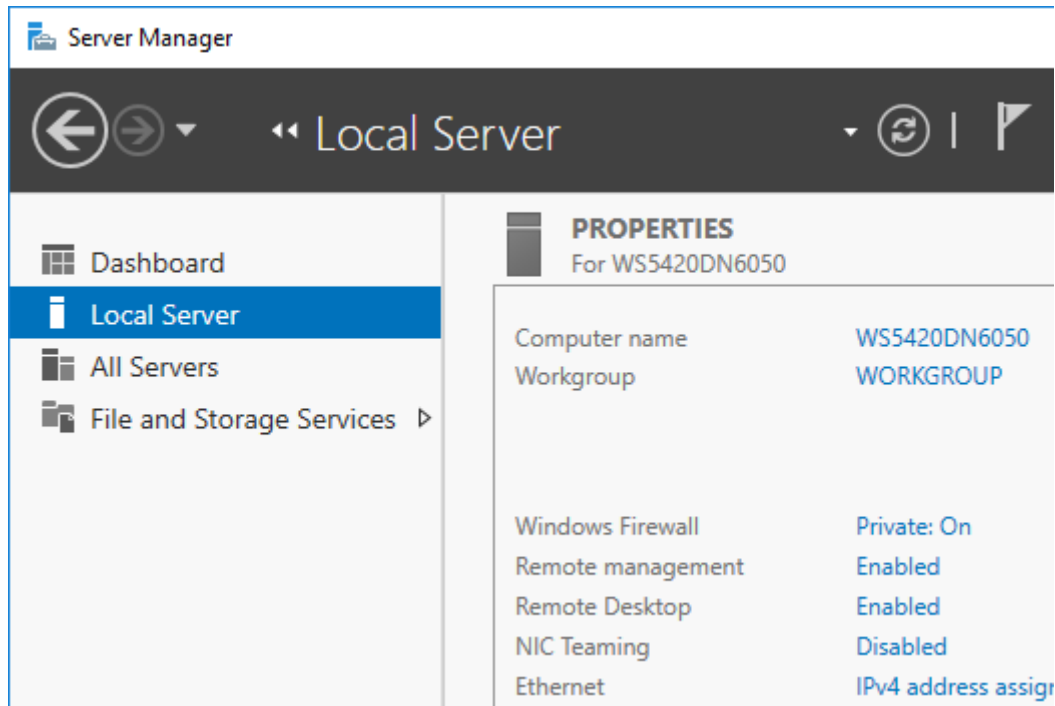

- 2 Click the hostname of your TeraStation.
- 3 From the *Computer Name* tab, click *Change*.

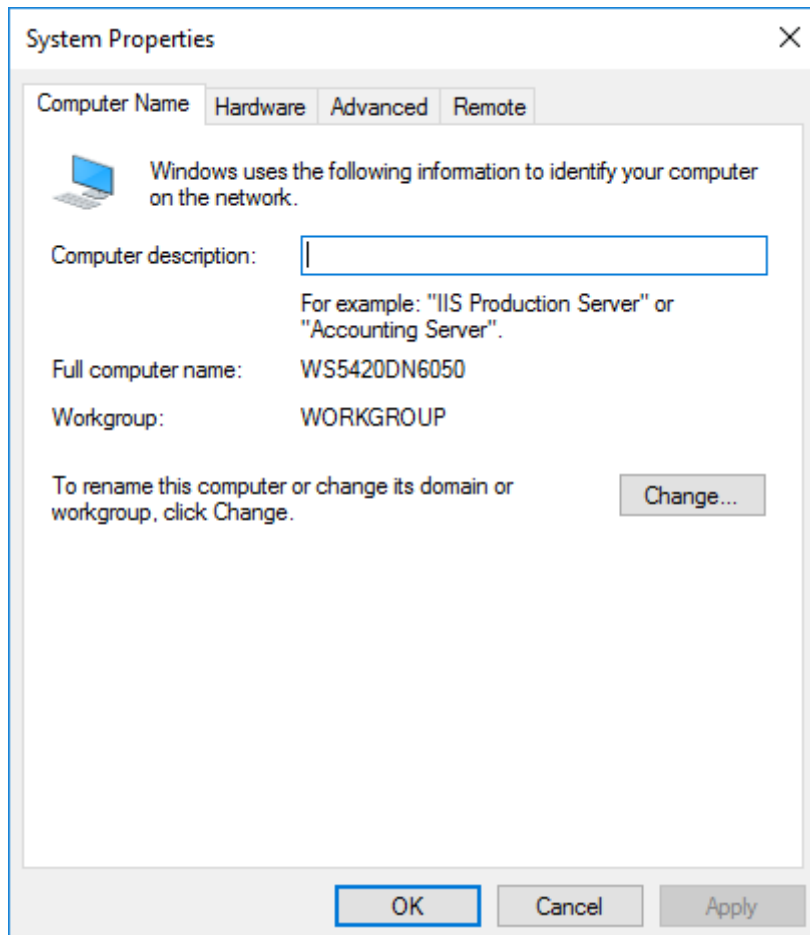

- 4** Select "Domain", enter a domain name, and click *OK*.

Computer Name/Domain Changes

You can change the name and the membership of this computer. Changes might affect access to network resources.

Computer name:  
WS5420DN6050

Full computer name:  
WS5420DN6050

More...

Member of

Domain:  
nas.buffalo.local

Workgroup:  
WORKGROUP

OK Cancel

- 5** Enter an administrator username and password for the Active Directory domain controller.

Windows Security

Computer Name/Domain Changes

Enter the name and password of an account with permission to join the domain.

User name

Password

Domain: nas.buffalo.local

OK Cancel

- 6** Click *OK*, then click *OK* again.

- 7** Click *Close*.

- 8** Click *Restart Now* and restart your computer to apply settings.

## Installing DFS

- 1 From Server Manager, click *Dashboard > Add roles and features*.

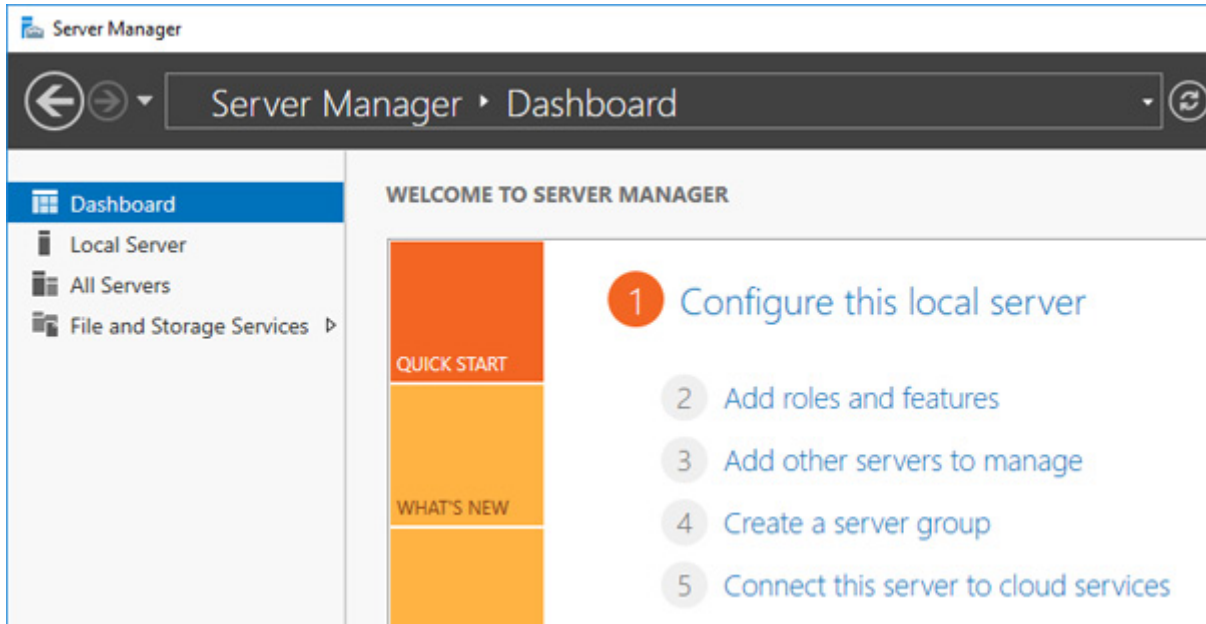

- 2 Click *Next*.
- 3 Select "Role-based or feature-based installation" and click *Next*.

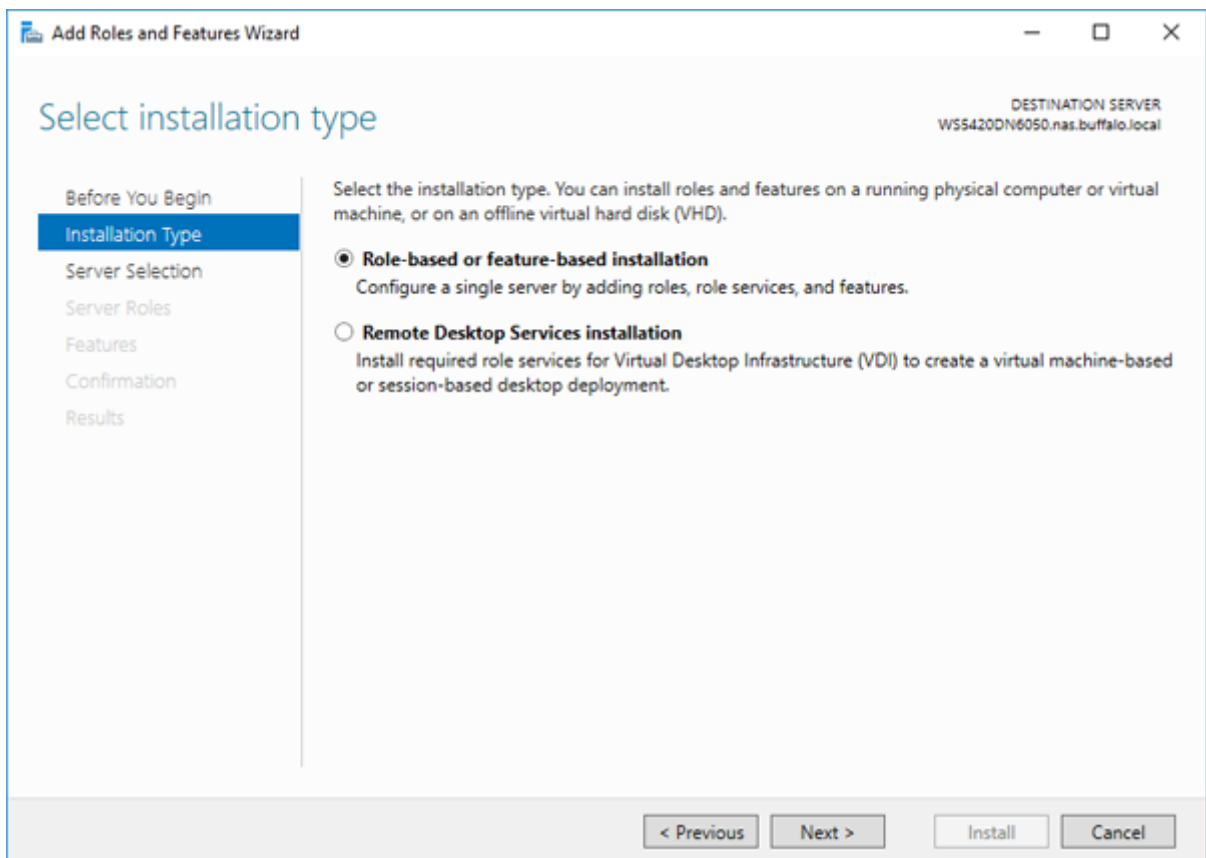

- 4 Click *Next*.

5 Select “DFS Namespaces” and “DFS Replication” under “File and Storage Services” > “File and iSCSI Services”.

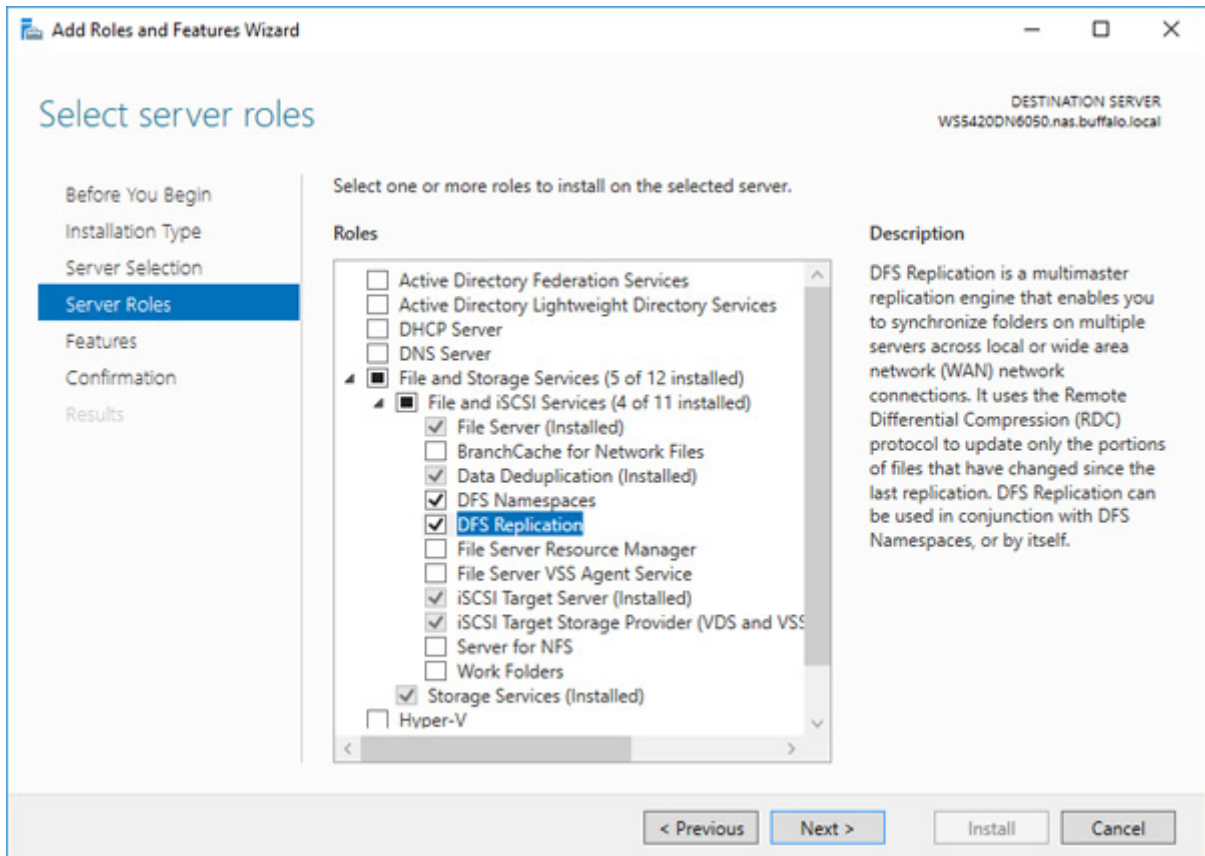

6 Select “Include management tools (if applicable)” and click *Add Features*.

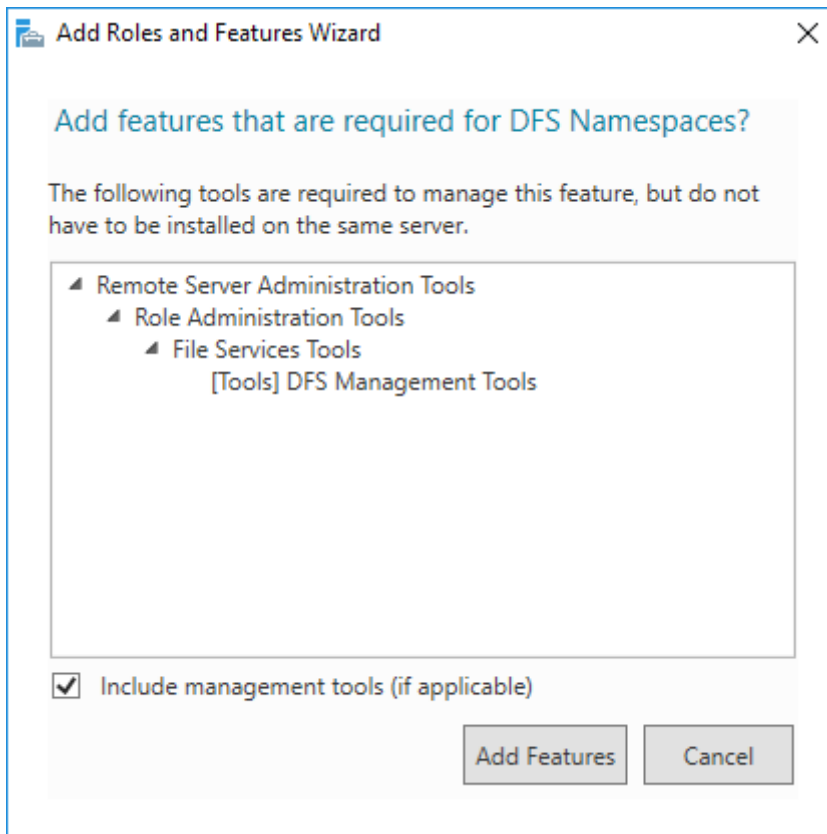

7 Click *Next* twice, then click *Install*.

**8** Click *Close* to finish.

## Creating Namespaces

**1** From Server Manager, click *Tools > DFS Management*.

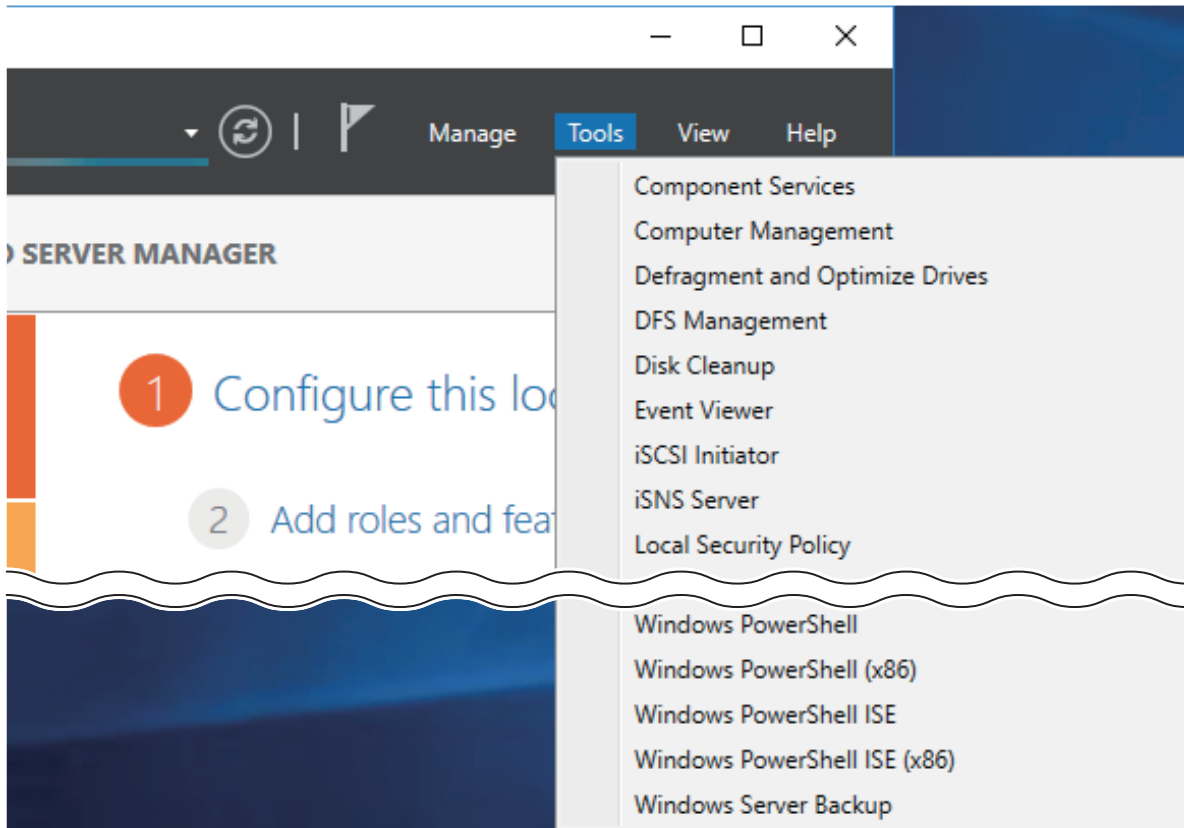

**2** Right-click *Namespaces*, then click *New Namespace*.

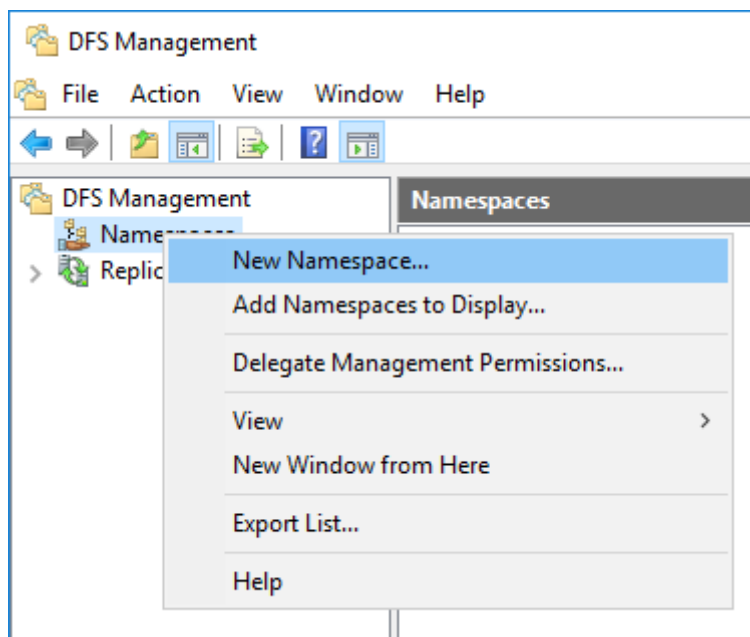

3 Enter a hostname for the namespace server and click *Next*.

The screenshot shows a window titled "New Namespace Wizard" with a standard Windows title bar (minimize, maximize, close). The main title is "Namespace Server". On the left, a "Steps:" pane lists the following steps: "Namespace Server" (highlighted), "Namespace Name and Settings", "Namespace Type", "Review Settings and Create Namespace", and "Confirmation". The main area contains the instruction: "Enter the name of the server that will host the namespace. The server you specify will be known as the namespace server." Below this is a "Server:" label, a text input field containing "WS5420DN6050", and a "Browse..." button. At the bottom right, there are three buttons: "< Previous", "Next >" (highlighted with a blue border), and "Cancel".

4 Enter a name for the namespace and click *Next*.

The screenshot shows a Windows-style dialog box titled "New Namespace Wizard". The window has standard minimize, maximize, and close buttons in the top right corner. The main title bar also contains a small icon of a folder with a sunburst. The dialog is divided into two main sections. On the left is a "Steps:" pane with a vertical list of steps: "Namespace Server", "Namespace Name and Settings" (which is currently selected and highlighted), "Namespace Type", "Review Settings and Create Namespace", and "Confirmation". The main area on the right is titled "Namespace Name and Settings" and contains the following text: "Enter a name for the namespace. This name will appear after the server or domain name in the namespace path, such as \\Server\Name or \\Domain\Name." Below this text is a "Name:" label followed by a text input field containing the word "Public". Underneath the input field is the text "Example: Public". A horizontal line separates this section from the next. The next section contains the text: "If necessary, the wizard will create a shared folder on the namespace server. To modify the settings of the shared folder, such as its local path and permissions, click Edit Settings." Below this text is a button labeled "Edit Settings...". At the bottom right of the dialog, there are three buttons: "< Previous", "Next >" (which is highlighted with a blue border), and "Cancel".



**5** Select *Domain-based namespace* and click *Next*.

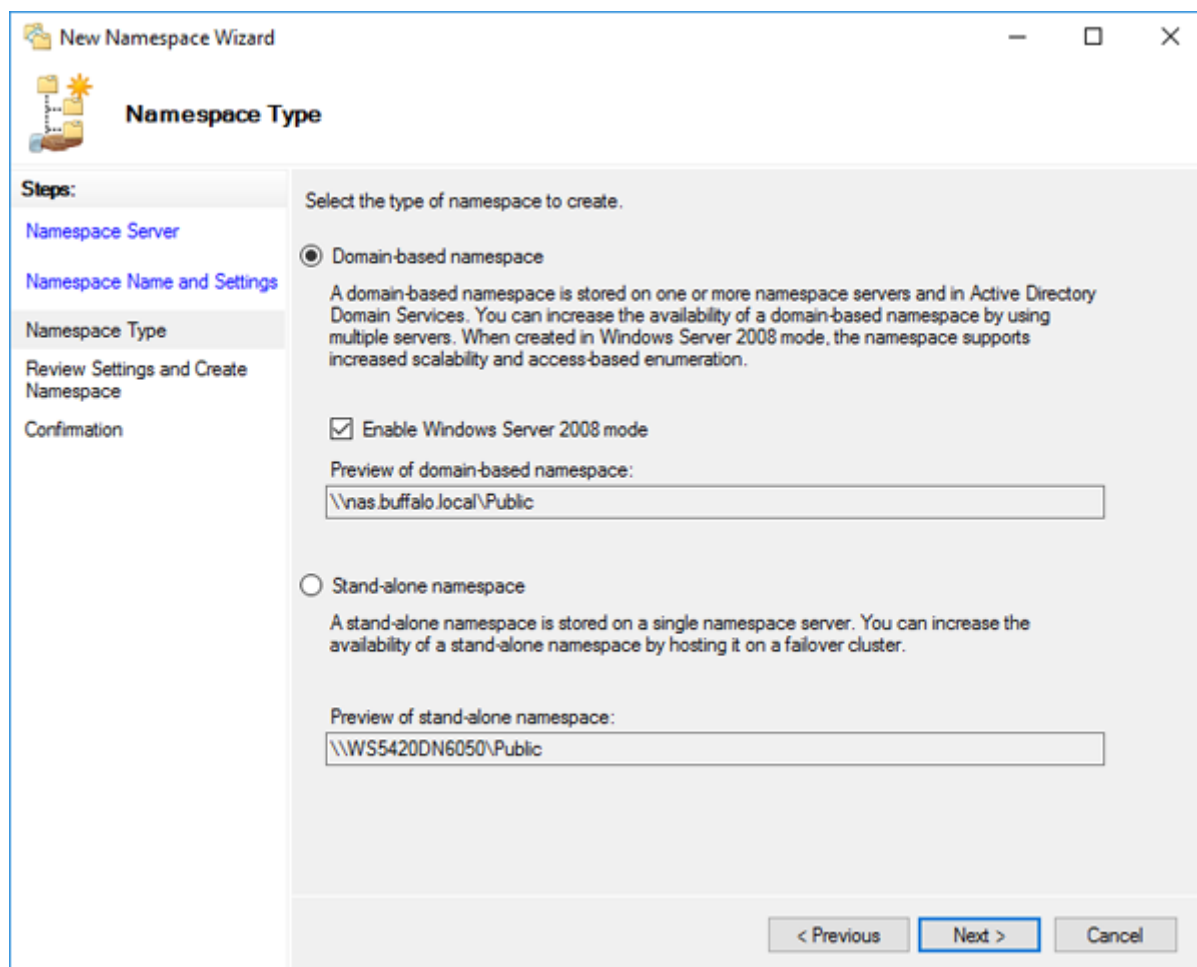

**6** Click *Create*.

**7** Click *Close* when the New Namespace Wizard finishes.

8 From DFS Management, right-click the name you created through the wizard and click *New Folder*.

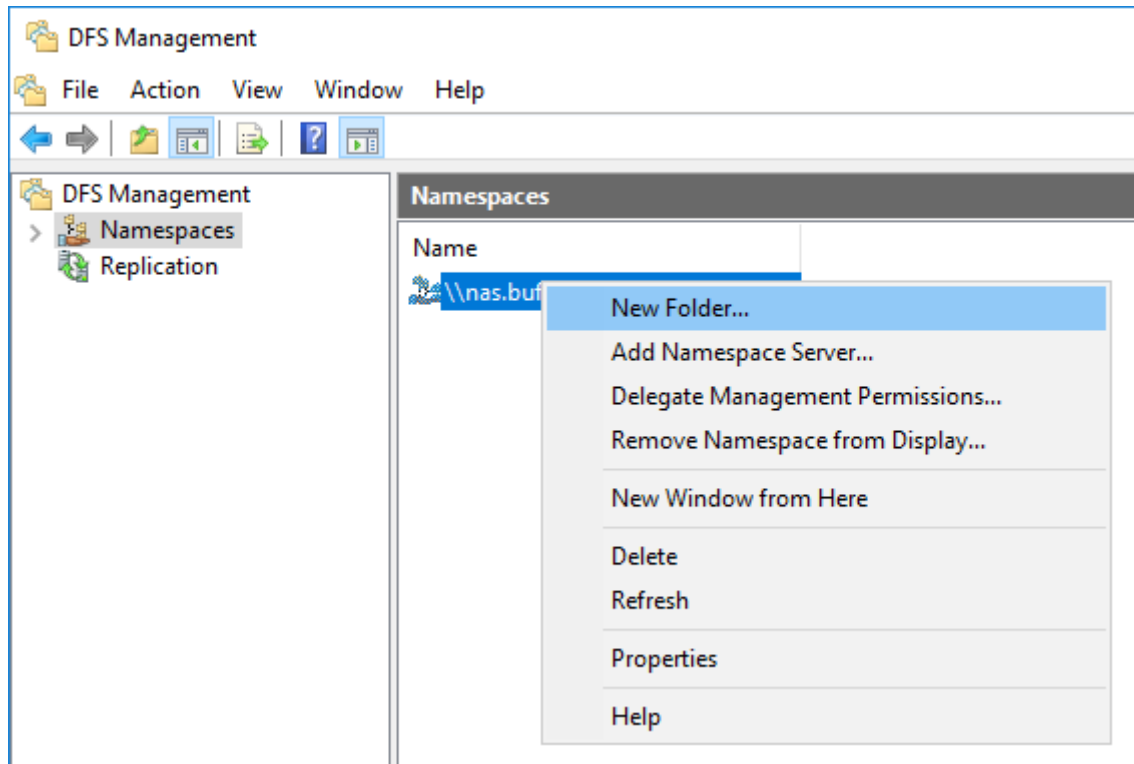

9 Enter a folder name and click *Add*.

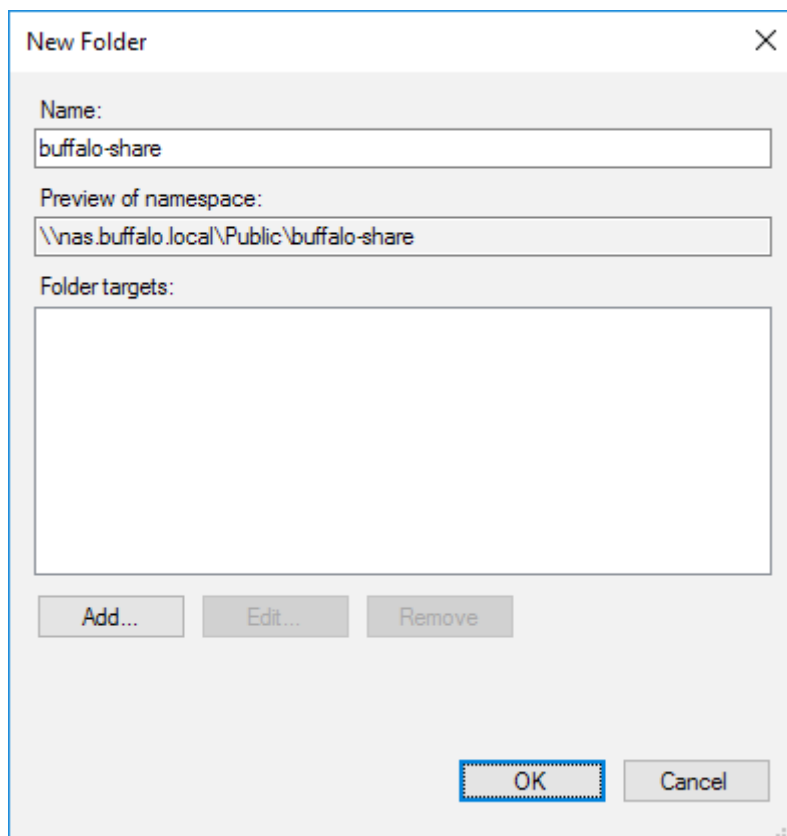

- 10** Enter a path to the folder or select from the list by clicking *Browse*. Click *OK*. You may be asked to create a new folder if the selected path doesn't exist. In such a case, click *Yes*.

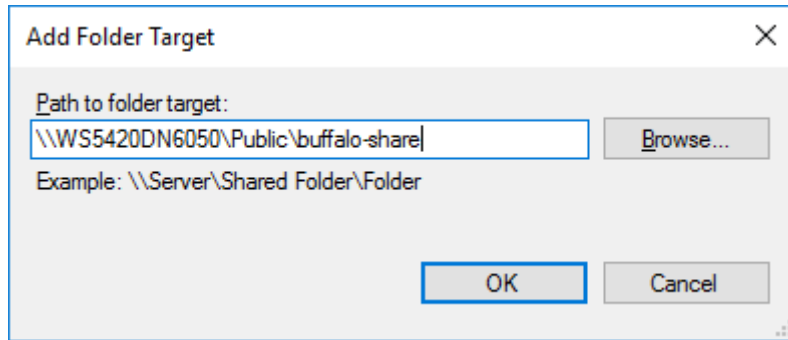

- 11** Click *OK* again.

## Configuring DFS Replication

- 1** From Server Manager, click *Tools > DFS Management*.

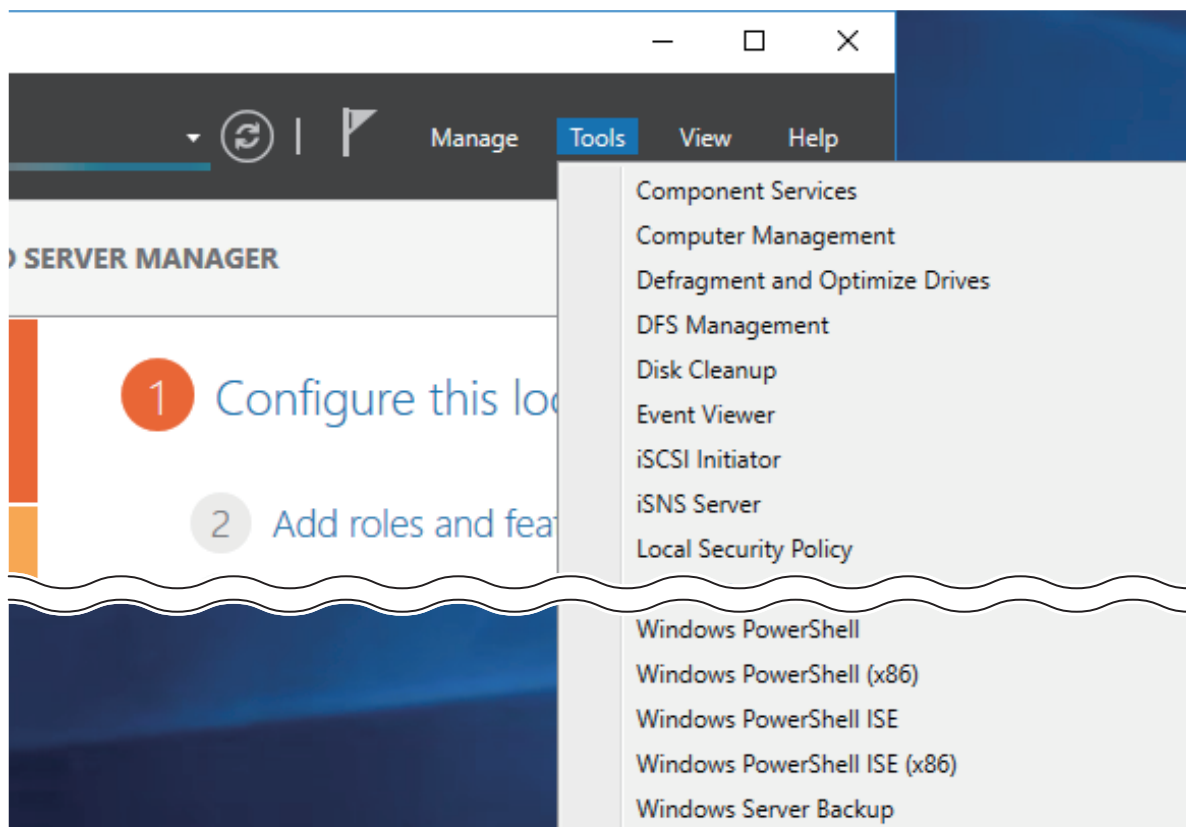

2 Right-click *Replication*, then click *New Replication Group*.

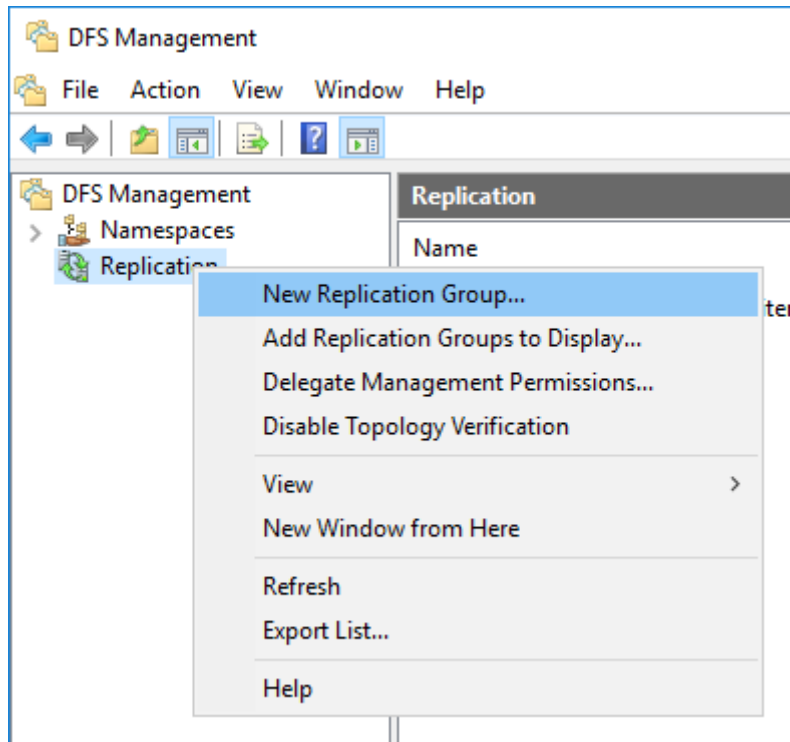

3 Select "Replication group for data collection" as the replication group type and click *Next*.

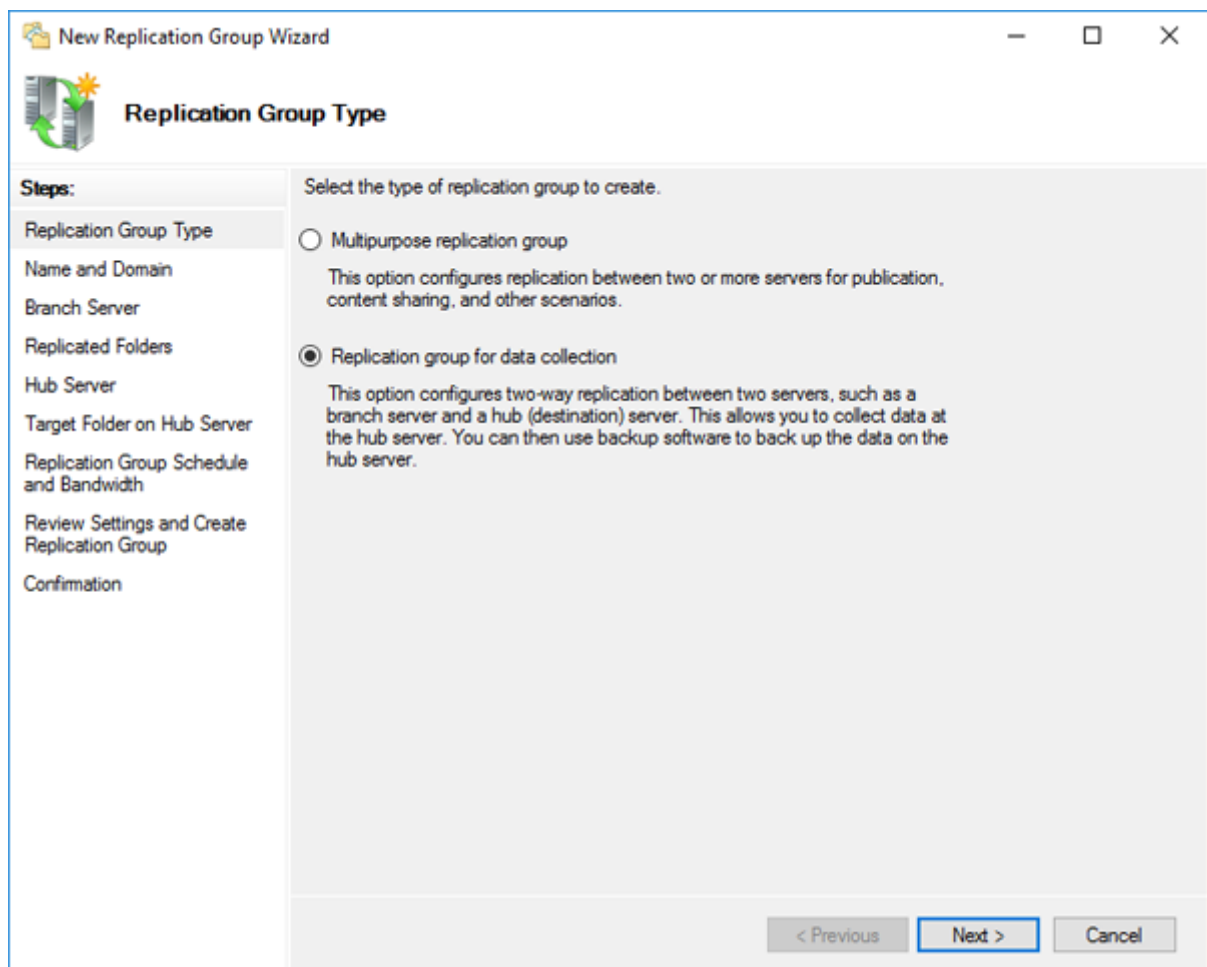

4 Enter a name for the replication group and click *Next*.

The screenshot shows the 'New Replication Group Wizard' dialog box, specifically the 'Name and Domain' step. The window title is 'New Replication Group Wizard'. The main heading is 'Name and Domain'. On the left, a 'Steps:' list includes: 'Replication Group Type', 'Name and Domain' (highlighted), 'Branch Server', 'Replicated Folders', 'Hub Server', 'Target Folder on Hub Server', 'Replication Group Schedule and Bandwidth', 'Review Settings and Create Replication Group', and 'Confirmation'. The main area contains the following fields and instructions:

- Instruction: 'Type a name and domain for the replication group. The name of the replication group must be unique in the domain that hosts the replication group.'
- Field: 'Name of replication group:' with the text 'Buffalo\_DFS' entered.
- Field: 'Optional description of replication group:' with an empty text box and a scroll bar.
- Field: 'Domain:' with the text 'nas.buffalo.local' entered and a 'Browse...' button to its right.

At the bottom right, there are three buttons: '< Previous', 'Next >' (which is highlighted with a blue border), and 'Cancel'.

**5** Enter the hostname of the file server for the replication source and click *Next*.

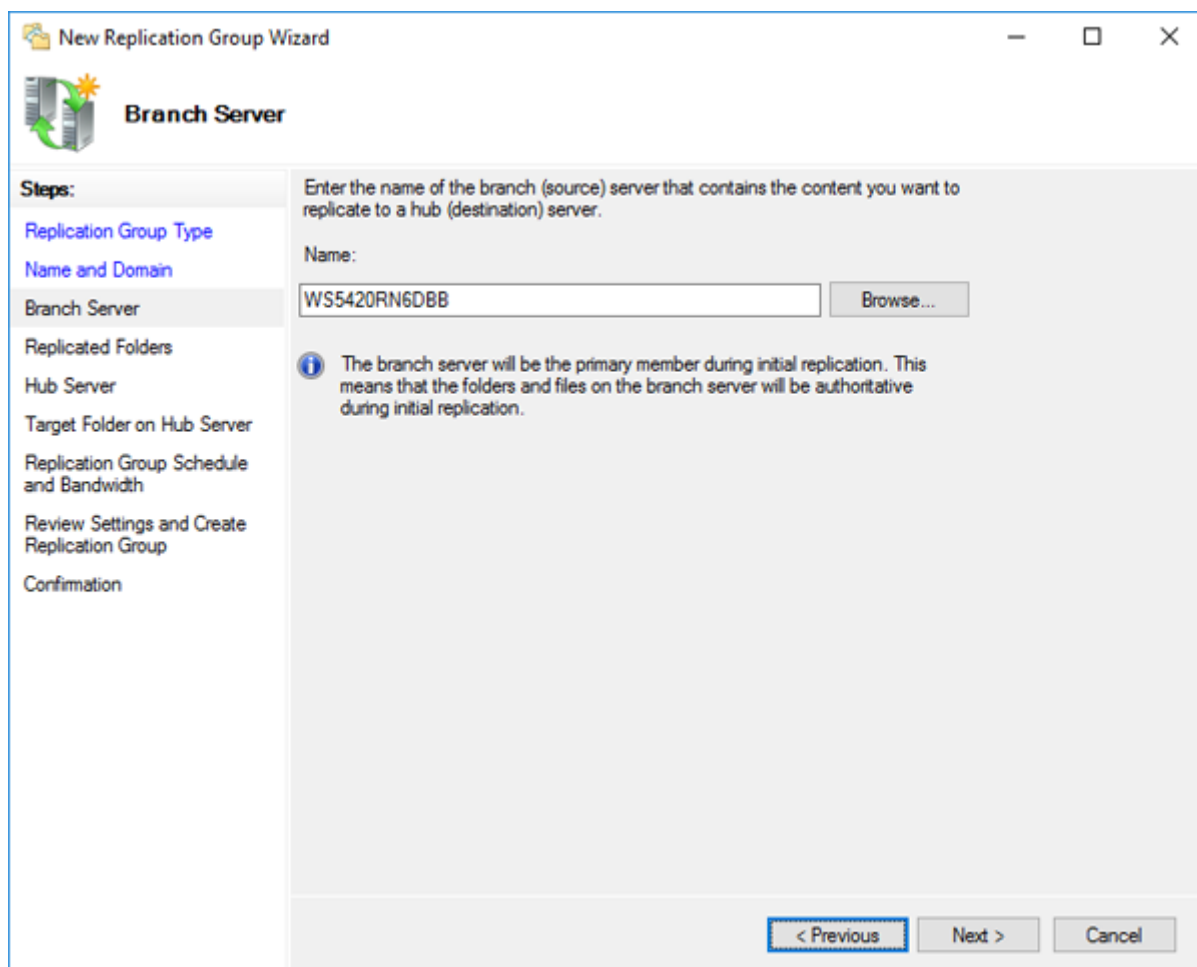

**6** Click *Add*.

**7** Enter the path or select the replication source folder and click *OK*.

**Add Folder to Replicate** [X]

Member:  
WS5420RN6DBB.nas.buffalo.local

Local path of folder to replicate:  
D:\rep\_src [Browse...]  
Example: C:\Documents

Select or type a name to represent this folder on all members of the replication group. This name is known as the replicated folder name.

Use name based on path:  
rep\_src

Use custom name:  
[ ]  
Example: Documents

[OK] [Cancel]

**8** Click *Next*.

9 Enter the hostname of the file server for the replication destination and click *Next*.

The screenshot shows a window titled "New Replication Group Wizard" with a "Hub Server" icon and title. On the left, a "Steps:" list includes: "Replication Group Type", "Name and Domain", "Branch Server", "Replicated Folders", "Hub Server" (highlighted), "Target Folder on Hub Server", "Replication Group Schedule and Bandwidth", "Review Settings and Create Replication Group", and "Confirmation". The main area contains the text: "Enter the name of the destination server where you will collect the replicated folders for backup or other purposes. This server is typically a hub server in a datacenter or other central location." Below this is a "Name:" label, a text box containing "SERVER-A", and a "Browse..." button. At the bottom right are buttons for "< Previous", "Next >", and "Cancel".



**10** Enter the path of the replication destination. Alternatively, click *Browse* and select the folder from the list.

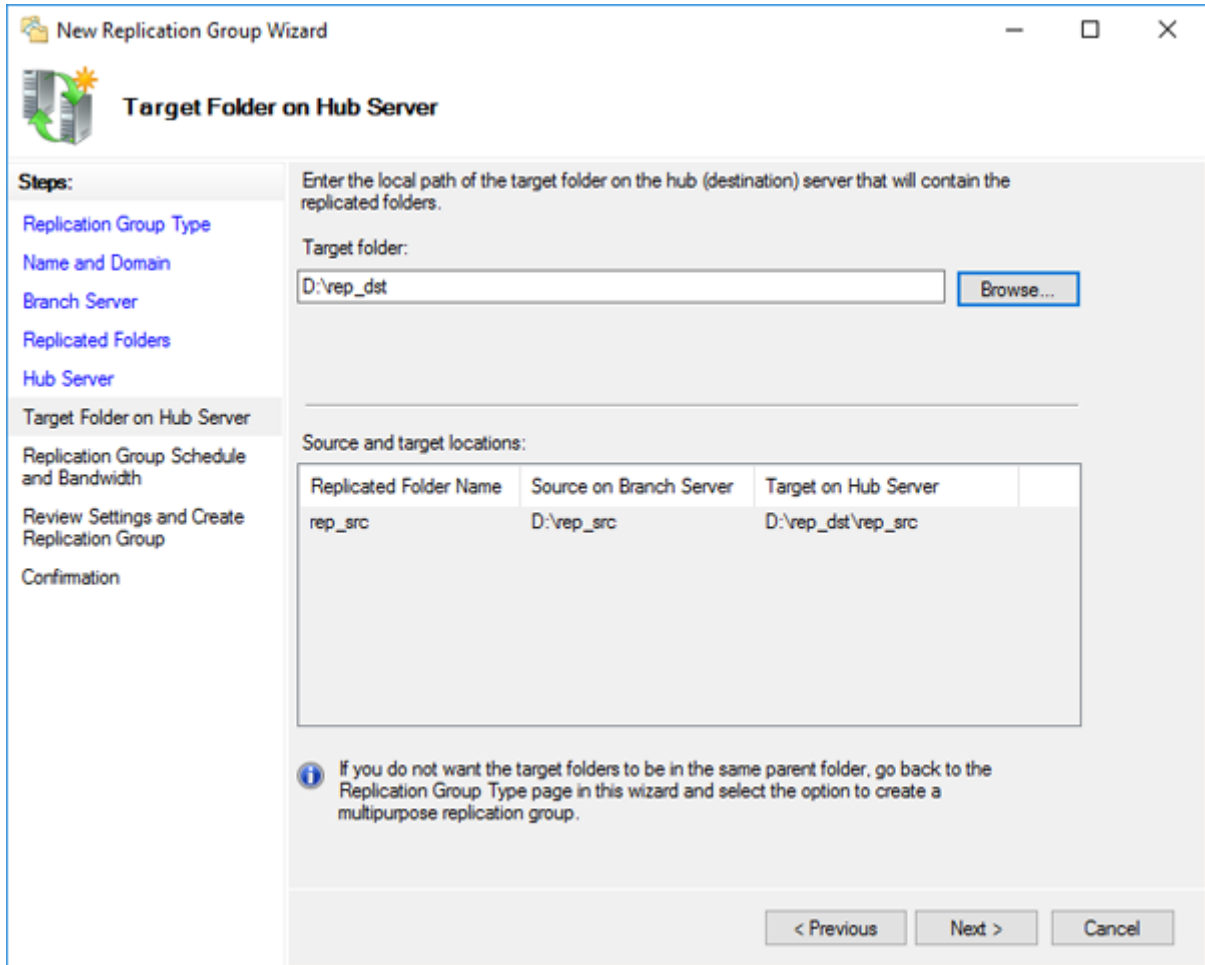

**11** Click *Next*, then click *Next* again.

**Note:** You have options to specify the network band and the date and time. To configure bandwidth, select *Replicate continuously using the specified bandwidth* and the bit rate from the drop-down list. To configure the schedule time, select *Replicate during the specified days and times* and click *Edit Schedule*. You can select the date and time in the displayed window.

**12** Click *Create*.

**13** Click *Close* when finished. DFS Replication is now configured.

**Note:** It may take some time before actual replication is caught up.

# Chapter 5 Additional Settings

## Changing Server Name, Workgroups, and Domains

1 From Server Manager, click *Local Server*.

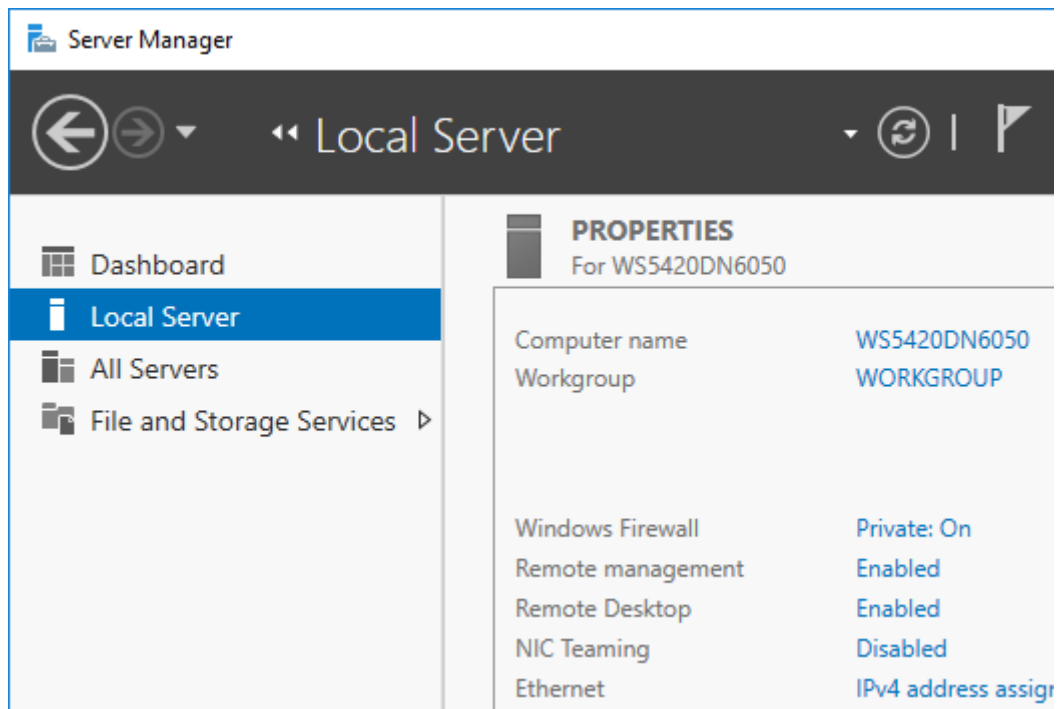

2 Click the hostname of your TeraStation.

**3** From the *Computer Name* tab, click *Change*.

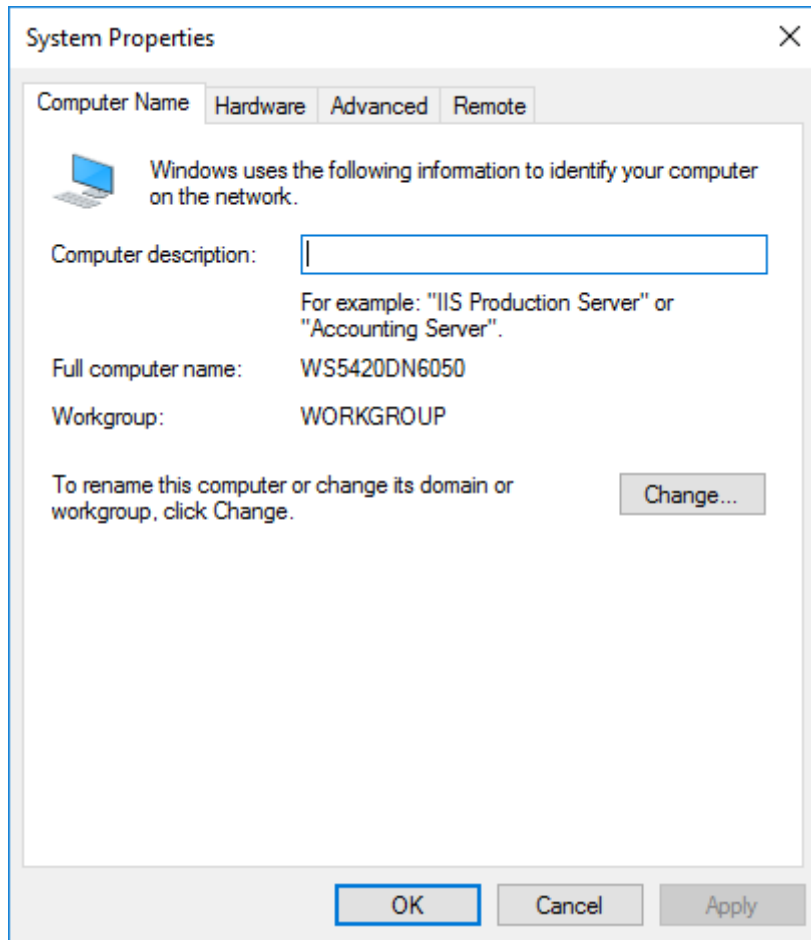

**4** Enter the computer name, choose domain or workgroup, and click *OK*.

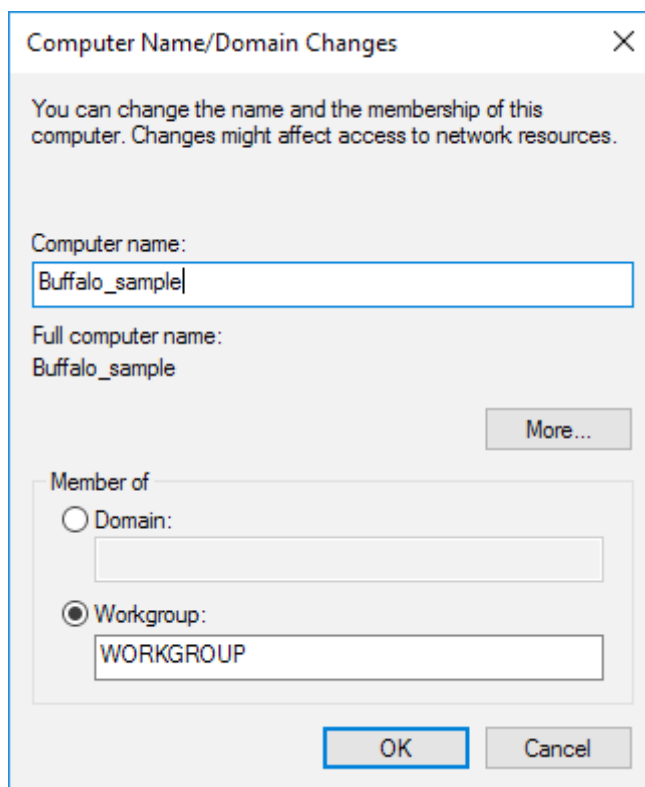

**Note:** The computer name should contain 16 characters or less. If more than 16 characters are entered, all characters from the 17th character on are ignored.

---

## Changing the Password

---

The default password for the TeraStation's administrator account is "password". This is public knowledge, so for security, you should change it immediately. Follow the procedure below to change the password.

### Administrator's Password

---

- 1 Log on to Windows Storage Server using "Administrator".
- 2 Press Ctrl+Alt+End.
- 3 Click *Change a password*.

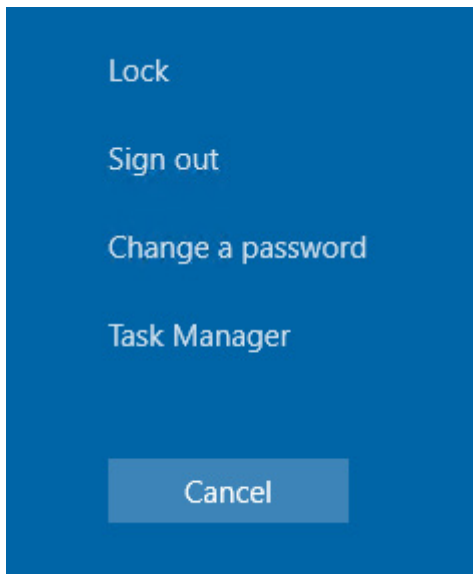

- 4 Enter the current administrator's password and a new password (twice), then press the Enter key.

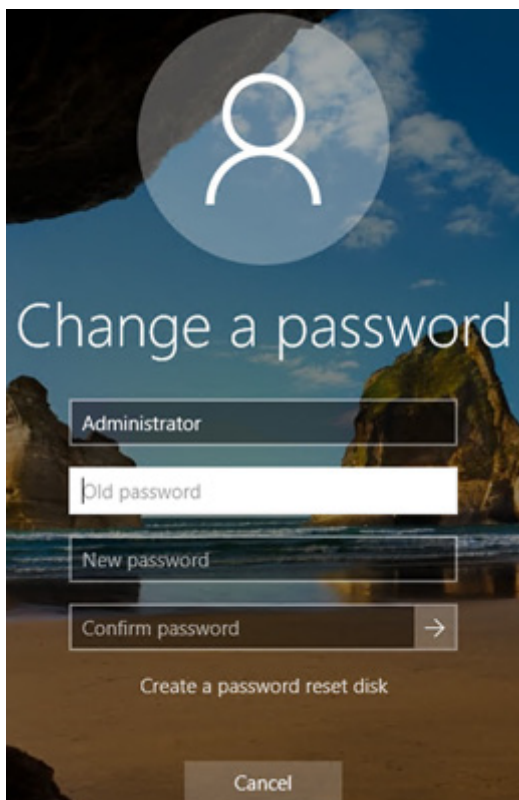

# Passwords for Other Users

1 From Server Manager, click *Tools > Computer Management*.

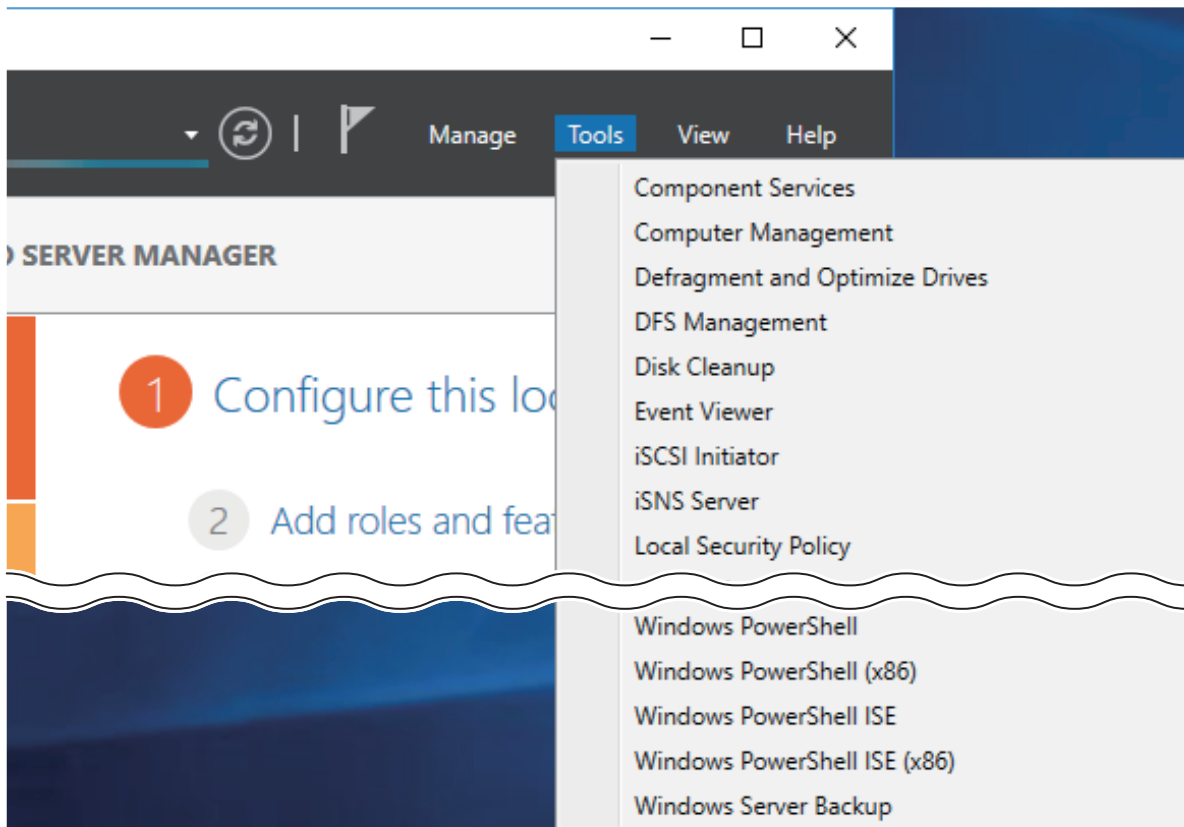

2 Click *Local Users and Groups*, then double-click *Users*.

3 Right-click the user whose password will be changed and click *Set Password*.

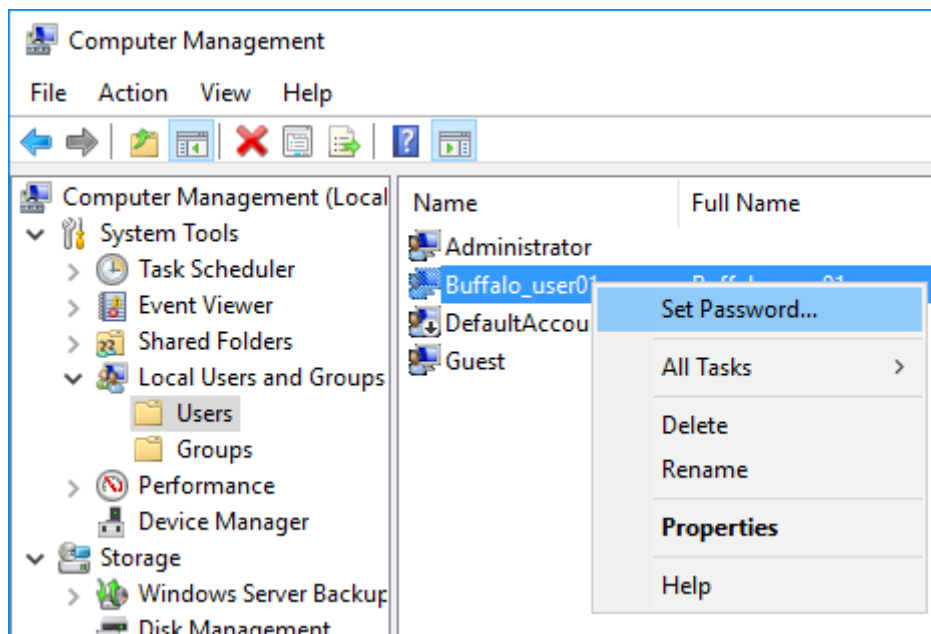

4 Click *Proceed*.

**5** Enter a new password (twice).

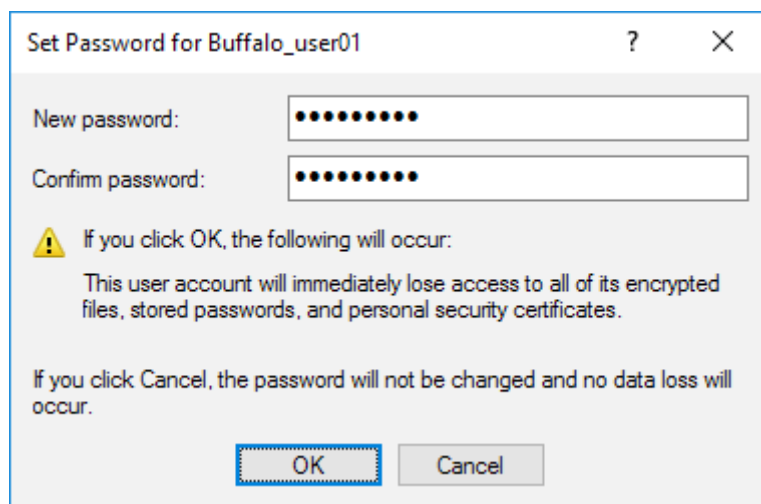

---

## Adding a User

---

**1** From Server Manager, click *Tools > Computer Management*.

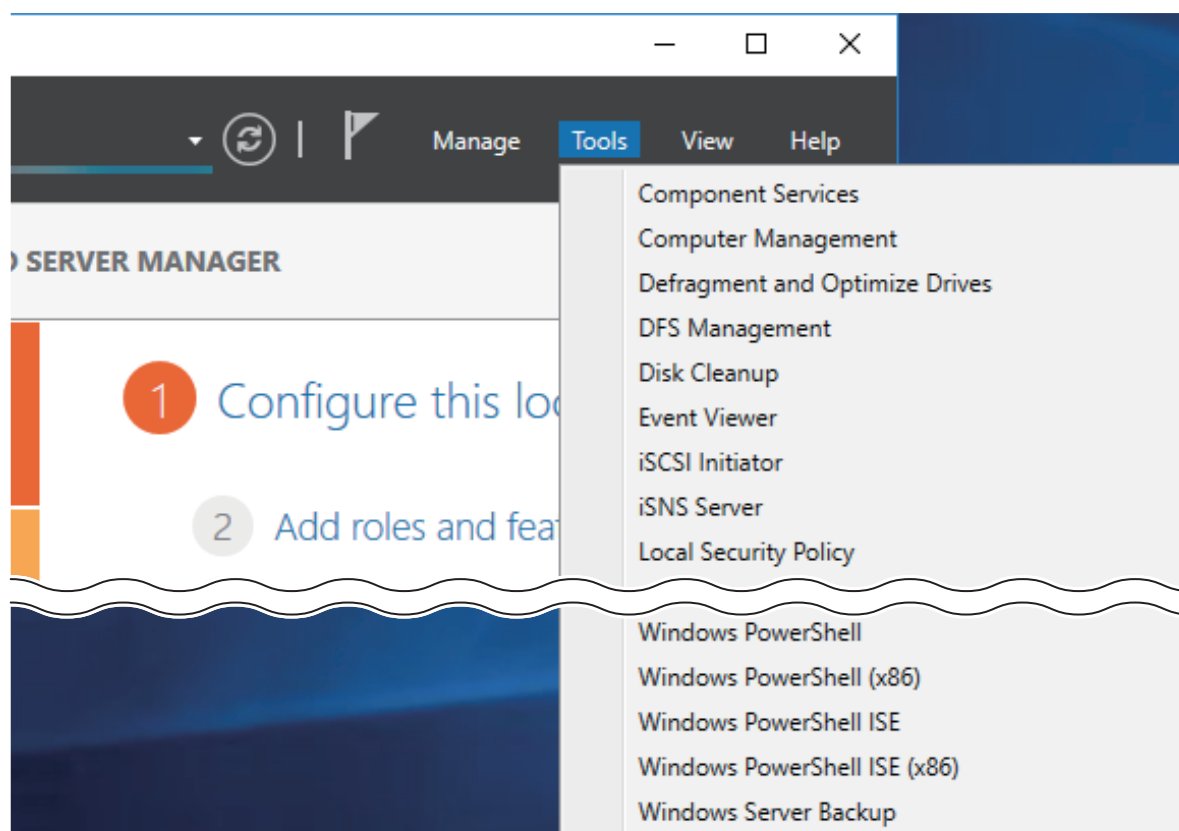

**2** Click *Local Users and Groups*.

**3** Right-click *Users* and click *New User*.

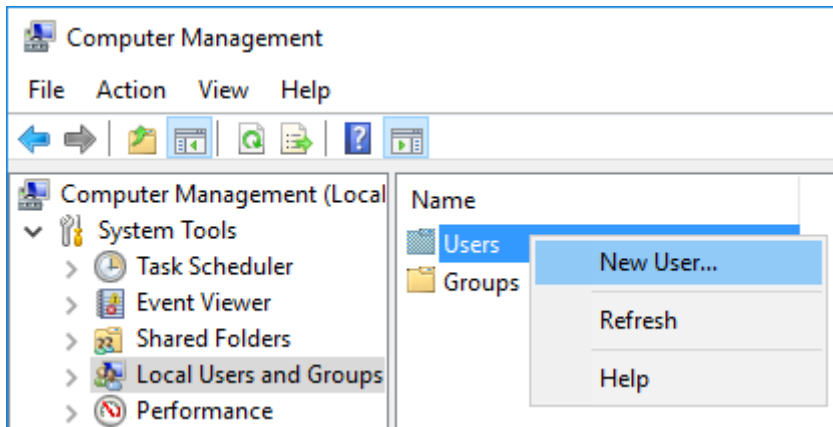

**4** Enter the desired settings and click *Create*.

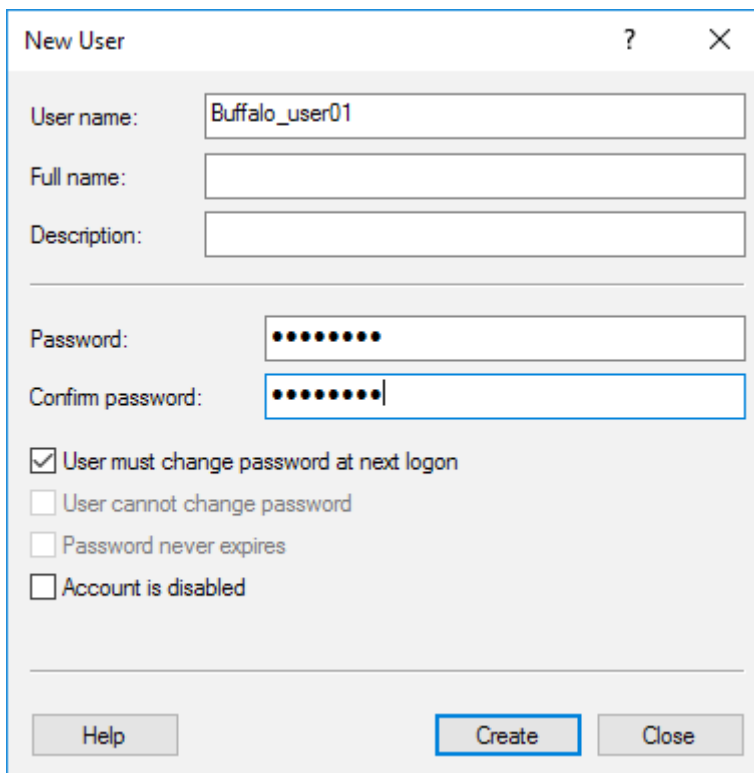

**5** Click *Close*.

---

## Connecting with Standard Accounts

---

Accounts not belonging to the Administrators group cannot connect to Windows Storage Server through the remote desktop. Those accounts must be added to the "Remote Desktop Users" group. Follow the procedure below to add accounts to the group.

**1** From Server Manager, click *Tools > Computer Management*.

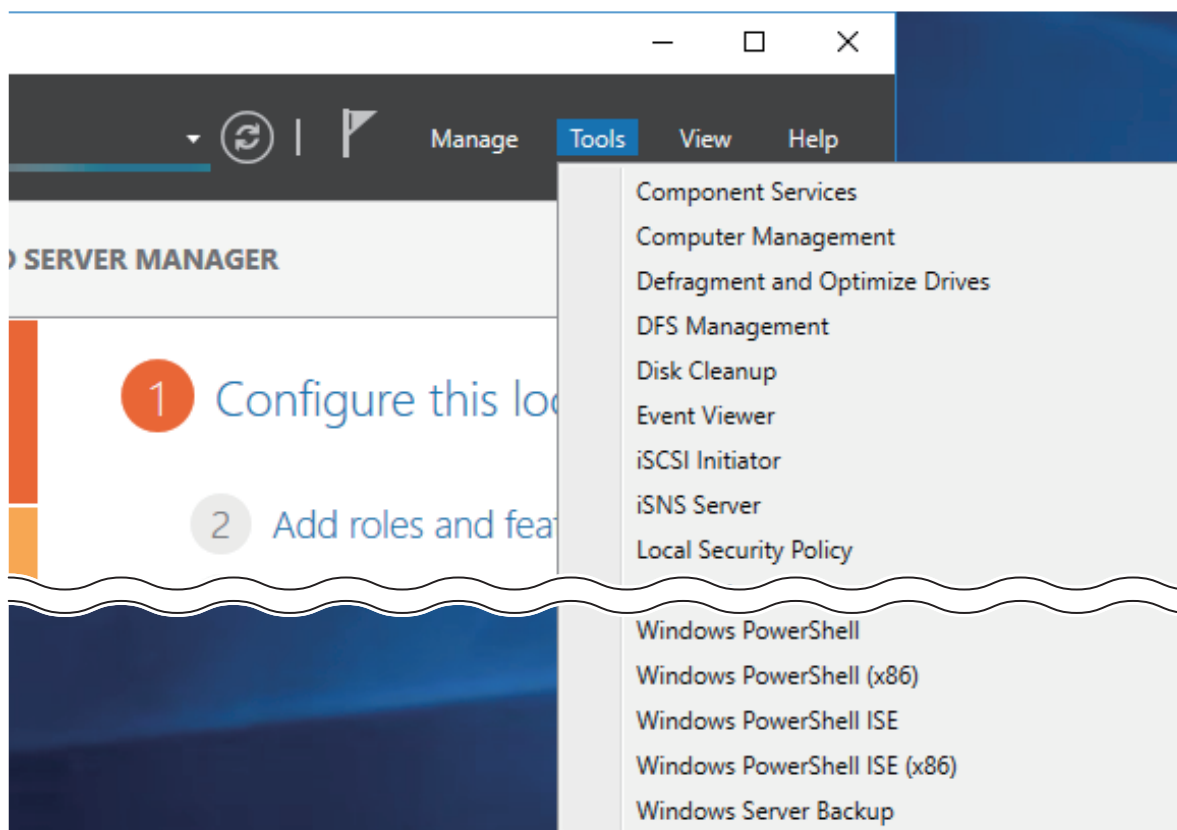

**2** Click *Local Users and Groups*, then double-click *Groups*.



**3** Double-click *Remote Desktop Users*.

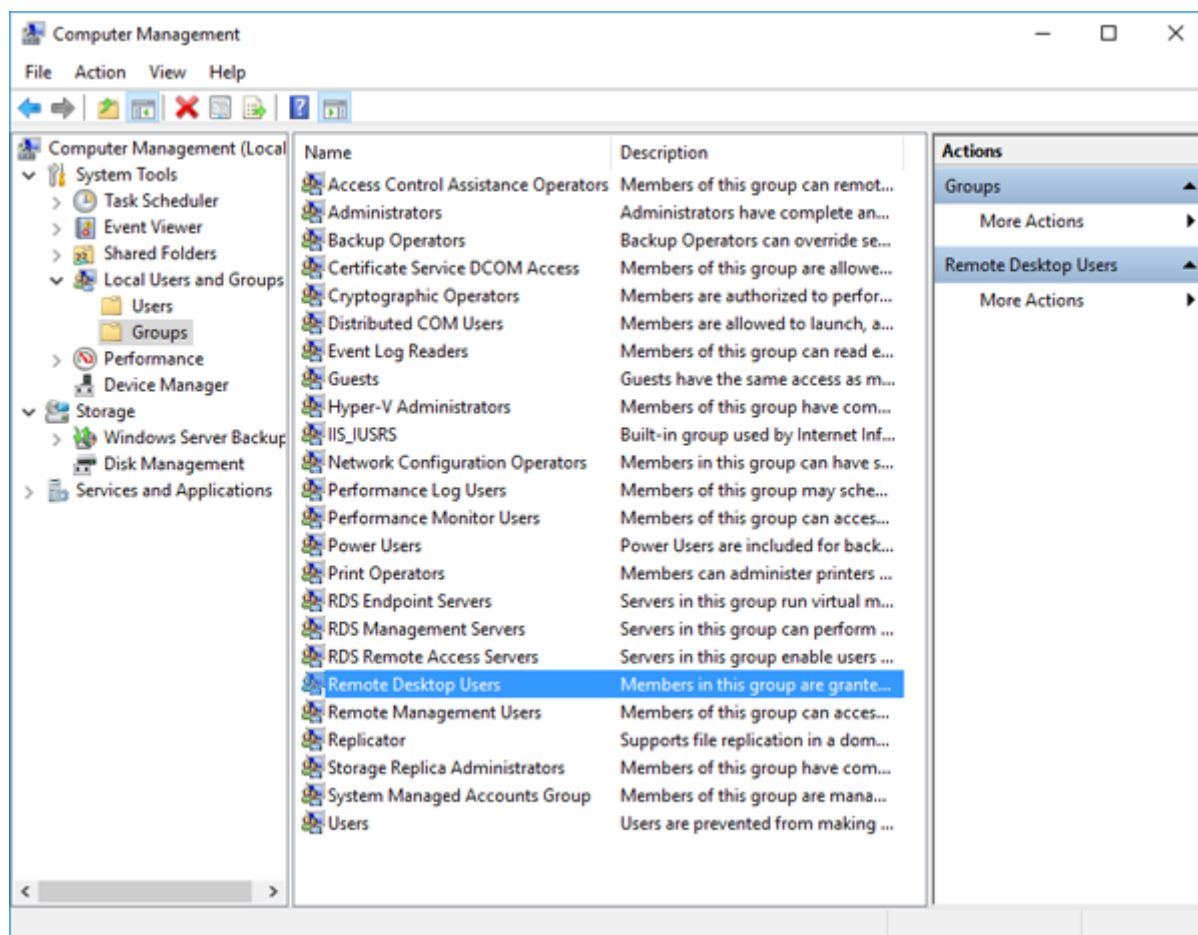

**4** Click *Add*.

**5** Click *Advanced*.

**6** Click *Find Now*.

**7** Select the user to be added as a group member and click *OK*.

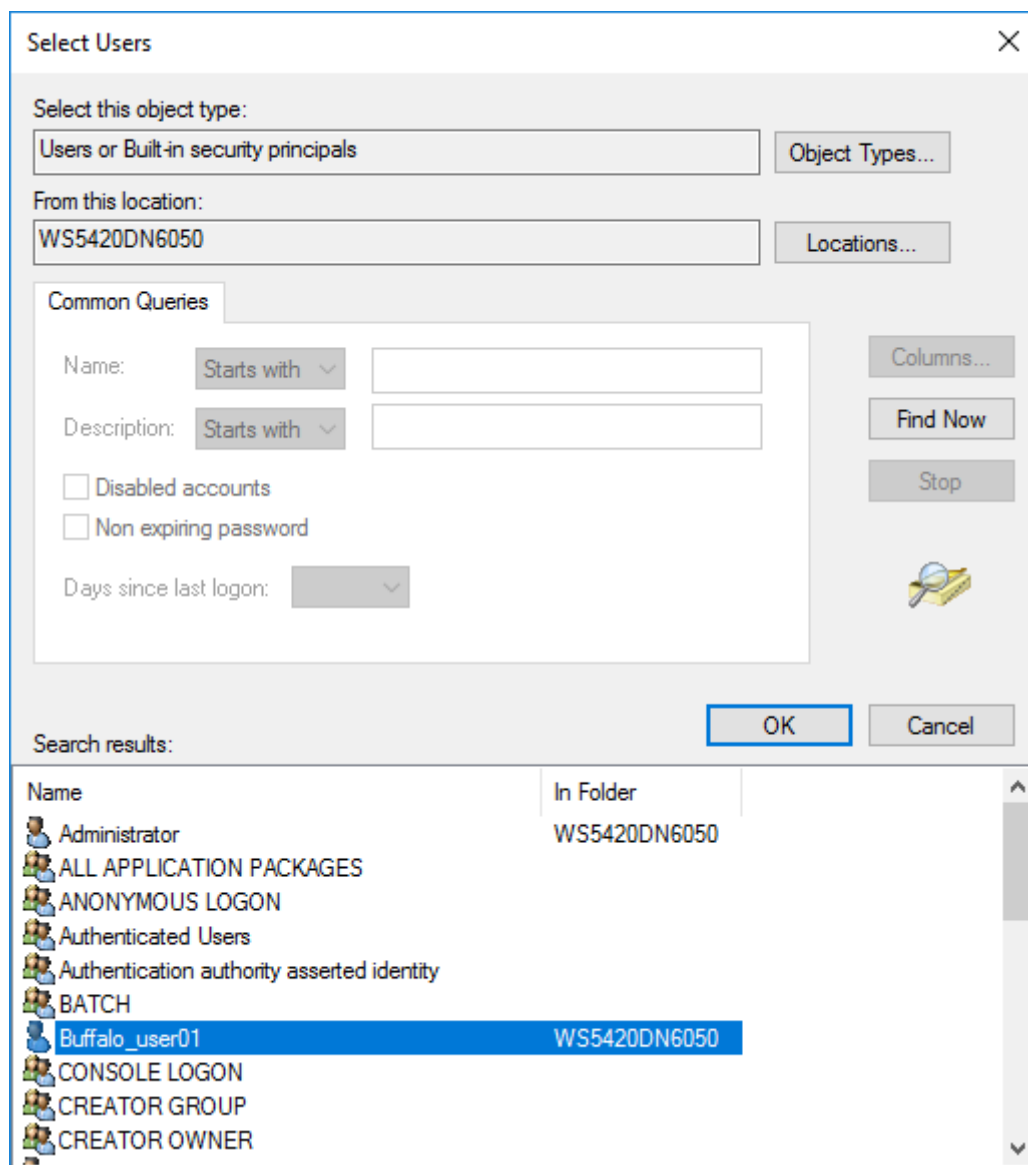

**8** Click *OK*, then click *OK* again.

# Adding a Group

- 1 From Server Manager, click *Tools > Computer Management*.

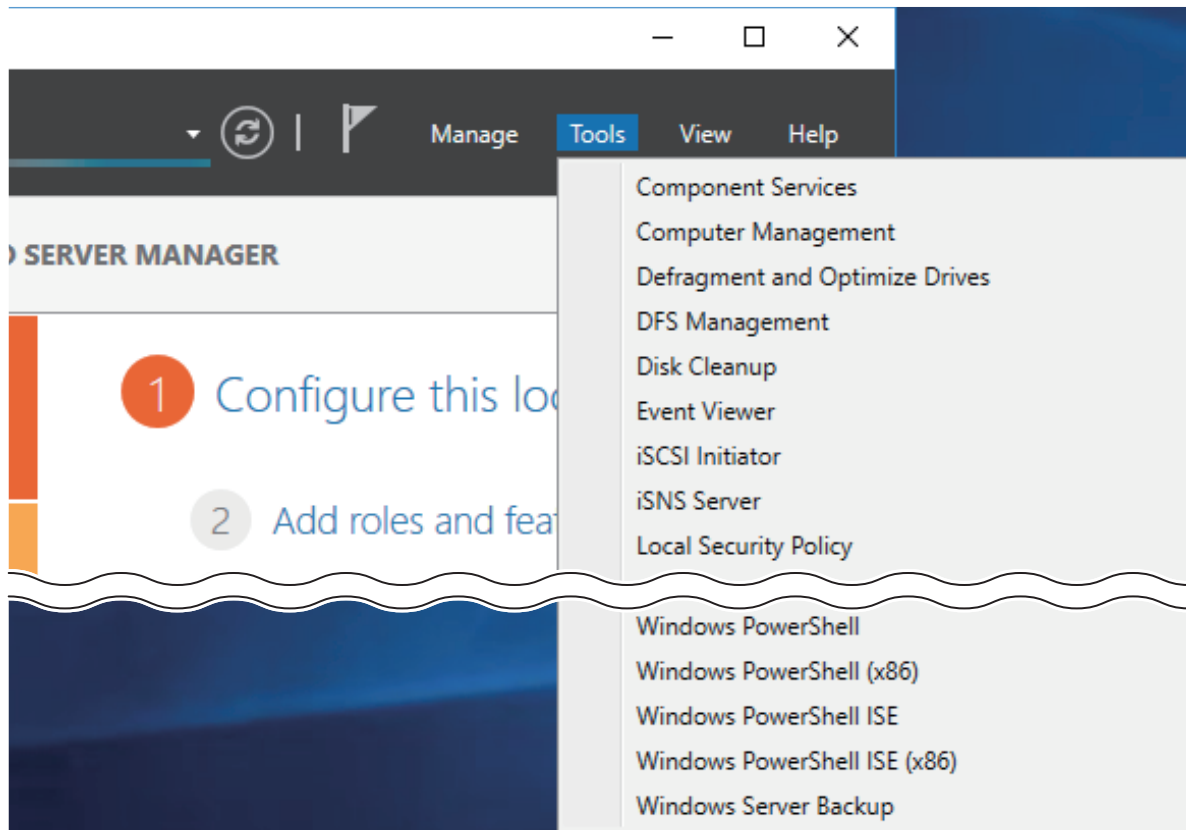

- 2 Click *Local Users and Groups*.
- 3 Right-click *Groups* and choose *New Group*.

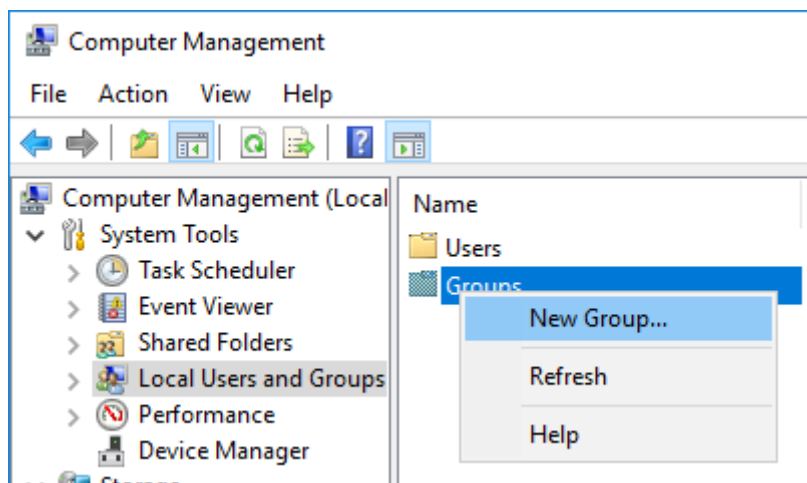

**4** Enter a group name and click *Add*.

The image shows a 'New Group' dialog box with the following fields and buttons:

- Group name:** Buffalo\_group01
- Description:** (empty)
- Members:** (empty list)
- Buttons:** Add..., Remove, Help, Create, Close

**5** Click *Advanced*.

**6** Click *Find Now*.

**7** Select the users to be registered to the group.

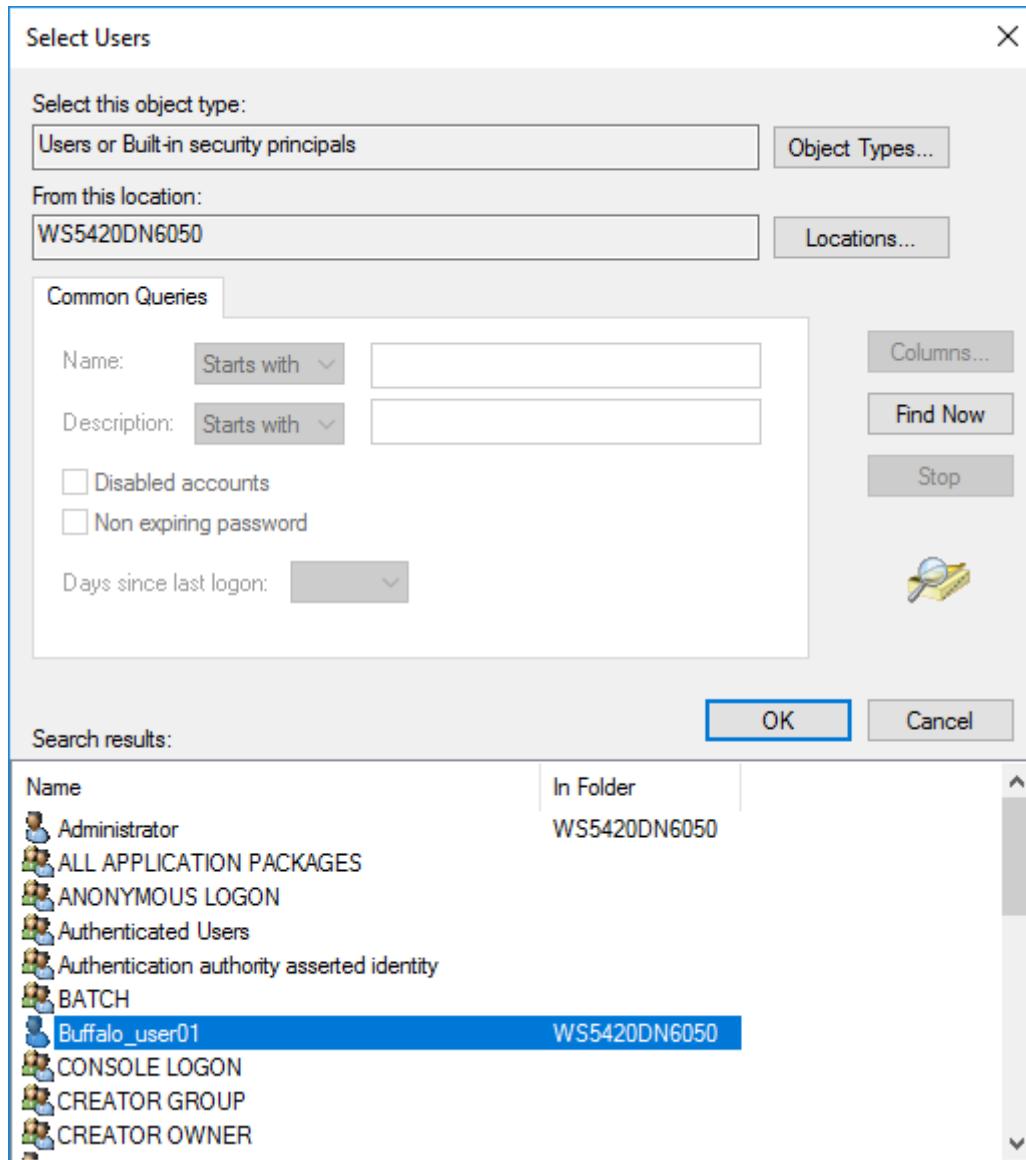

**8** Click *OK*, then click *OK* again.

**9** Click *Create*.

**10** Click *Close*.

---

## Enabling Email Notification

---

Your TeraStation can send you email reports daily, or when settings are changed or an error occurs. Notification emails may be triggered by any of TeraStation reports or Windows event logs.

## Configuring Email Server

---

**1** Click the Start button and click *Email Notification*.

**2** Select the “Enable email notification” checkbox.

**3** Click *New* and enter an email address.

**4** Enter your email server settings. Click *OK* to finish the email notification settings. You can send a test email when clicking *Test Message*.

**5** Enter the password of the user you’re logged in as and click *OK*.

Items	Descriptions
Enable email notification	If enabled, email reports will be sent during specific events.
Send to	Adds a new receiver for the notification email. Click <i>New</i> to add a new email address. Click <i>Edit</i> to change the receiver settings or <i>Delete</i> to remove an address from the list. <b>Note:</b> Up to five email addresses may be added.

Items	Descriptions
Authentication	<p><b>SMTP Server Address:</b> Enter your email SMTP server's address and port number. Port number 25 is configured by default.</p> <p><b>Note:</b> If you choose "None" or "POP before SMTP" for the user authorization, the port number is locked to "25".</p> <p><b>User Authentication Method:</b> Select the user authorization type from "None", "POP before SMTP", "LOGIN (SMTP-AUTH/LOGIN)", and "CRAM-MD5 (SMTP-AUTH/CRAM-MD5)". If "POP before SMTP" is selected, enter the POP server address and port number. Unless the port is specified, the standard port number (110) is used.</p> <p><b>Username and Password:</b> Enter the username and password of your email server.</p> <p><b>SSL/TLS:</b> If "LOGIN (SMTP-AUTH/LOGIN)" or "CRAM-MD5 (SMTP-AUTH/CRAM-MD5)" is selected, select whether to use SSL/TLS or STARTTLS.</p>
Email Settings	<p><b>Sender Address:</b> Enter the sender's email address for notification emails.</p> <p><b>Title:</b> Enter the subject of the notification email.</p> <p>Click <i>Content Options</i> to select the event that will trigger the notification emails to be sent.</p>
Test Message	Sends a test email to the email address which is configured.

## Specifying TeraStation Reports

---

A notification email can be sent using TeraStation reports.

- 1 Click the Start button and click *Email Notification*.
- 2 Click *Content Options*.

**3** Click the *Report Settings* tab and select the “Use TeraStation reports to determine notification type” checkbox.

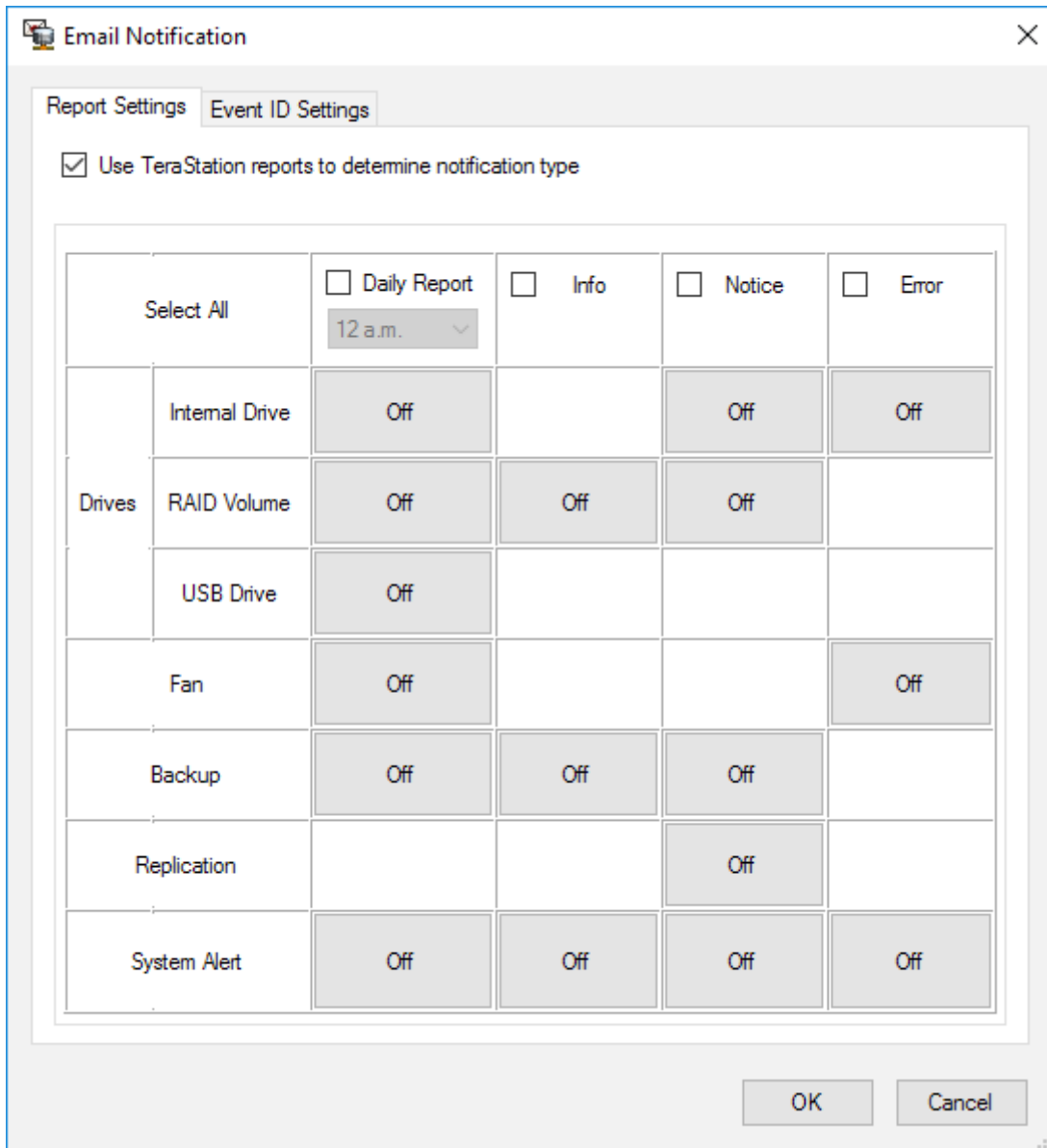

**4** Click *On* or *Off* to enable/disable the notifications of the function. When you select the checkboxes to the left of each log level, all notifications of the line will be selected at once.

**5** Click *OK*, then click *OK* again.

**6** Enter the password of the user you’re logged in as and click *OK*.

The notification emails will be categorized into the following importance levels.

Levels	Details
Daily Report	Describes the status of the TeraStation in a daily report email.
Info	Sends a notification email if an event occurs. Info reports will contain just information such as capacity information, backup job starts/finishes, etc.
Notice	Sends a notification email if a non-critical error occurs. Notice reports will contain warnings such as something has failed, but the function or TeraStation can continue operating as usual. It is recommended to do the corrective action for the notice as soon as possible.



Levels	Details
Error	Sends a notification email if an error occurs. Error reports will describe any critical failures that prevented a function or TeraStation from operating. It is recommended to do the corrective action for the error immediately.

## Specifying Windows Event Logs

A notification email will be sent when the specified event occurs. This section describes notifications using Windows Update events.

- 1** Click the Start button and click *Email Notification*.
- 2** Click *Content Options*.
- 3** Click the *Event ID Settings* tab and select the “Use Windows event logs to determine notification type” checkbox.

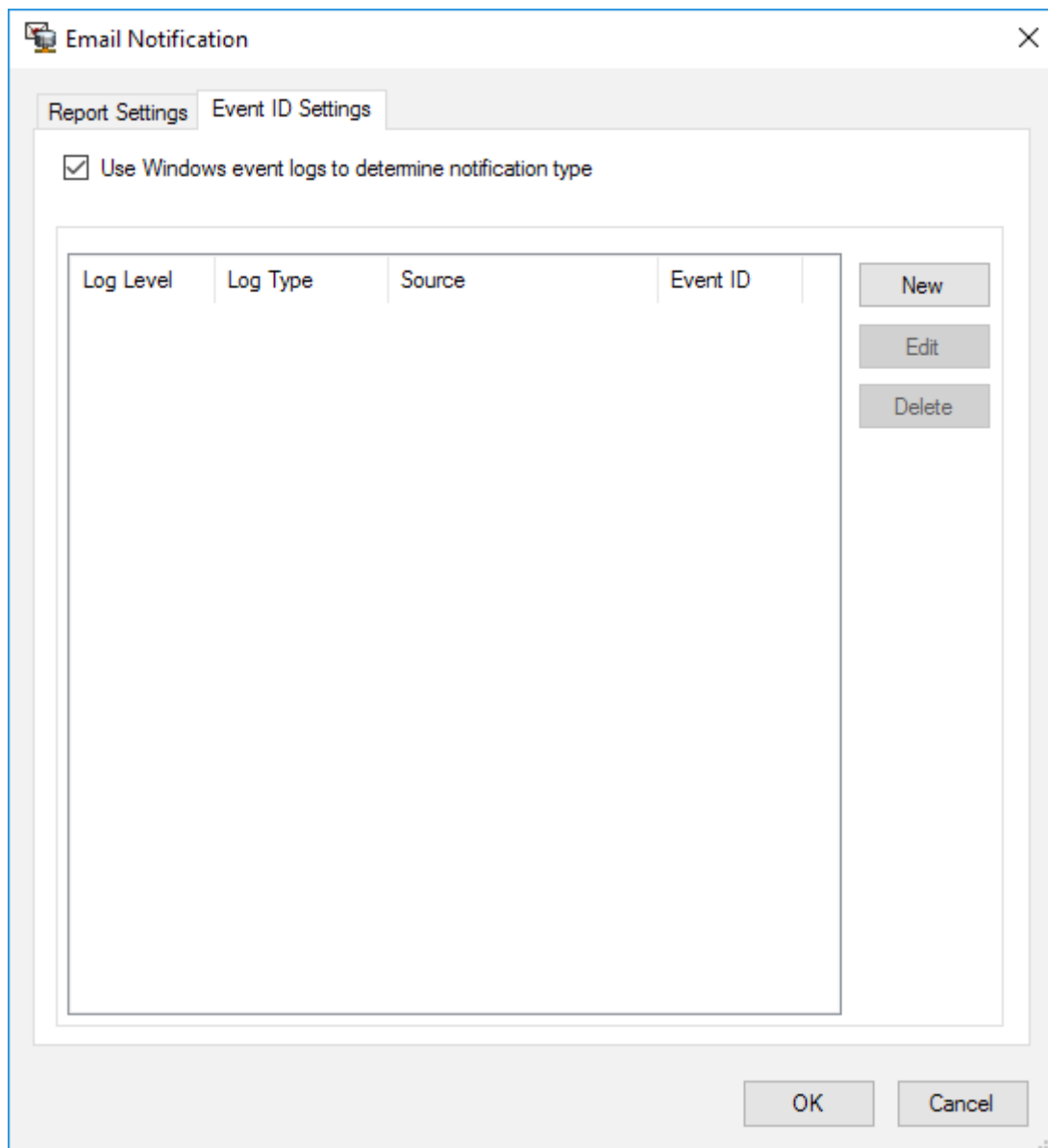

- 4** Click *New*.
- 5** Select the importance level from the “Log Level” list.

- 6 Select "System" from the "Log Type" list.
- 7 Enter "Microsoft-Windows-WindowsUpdateClient" into the "Source" box.
- 8 An event ID can be blank. All events triggered by Windows Update will be notified. If you prefer only being notified of specific events, enter those event IDs.
- 9 Click *OK*, then click *OK* again.
- 10 Enter the password of the user you're logged in as and click *OK*.

---

## Changing Front Panel Settings

---

You may configure options for the LCD panel and adjust the brightness of the LCD panel and LEDs on the TeraStation.

- 1 Click the Start button and click *Display Settings*.
- 2 Configure the desired settings and click *OK*.

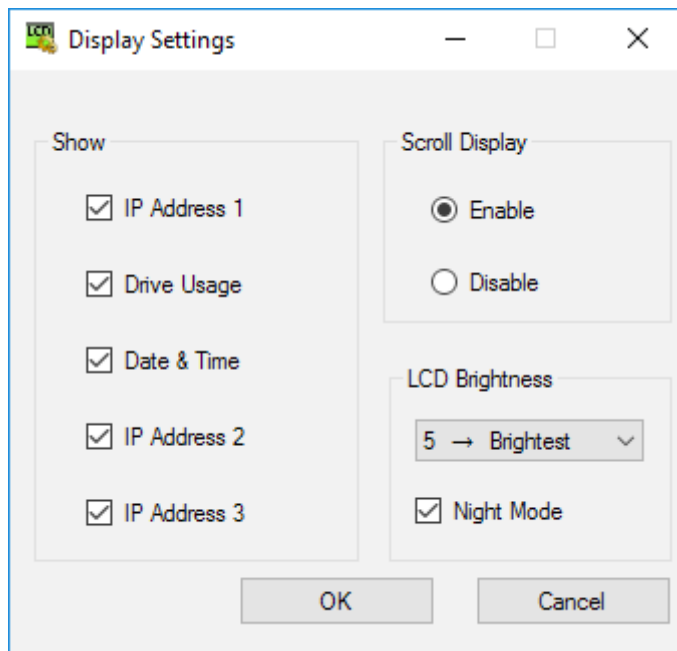

Items	Descriptions
Show	Select the items to be displayed on the LCD panel.
Scroll Display	If enabled, the LCD scrolls through display items at a regular interval.
LCD Brightness	Change the brightness of the LCD panel and LEDs from level 1 (darkest) to 5 (brightest). If you select the "Night Mode" checkbox, the LCD brightness will be set at level 2 (dark) from 6 p.m. to 8:59 a.m. the next day. <b>Note:</b> If the brightness is already set to level 1 (darkest) or level 2 (dark), night mode will be grayed out and cannot be selected.

---

## Acquiring Windows Event Logs

---

To acquire event logs of the TeraStation, follow the procedure below.

**1** From Server Manager, click *Tools > Event Viewer*.

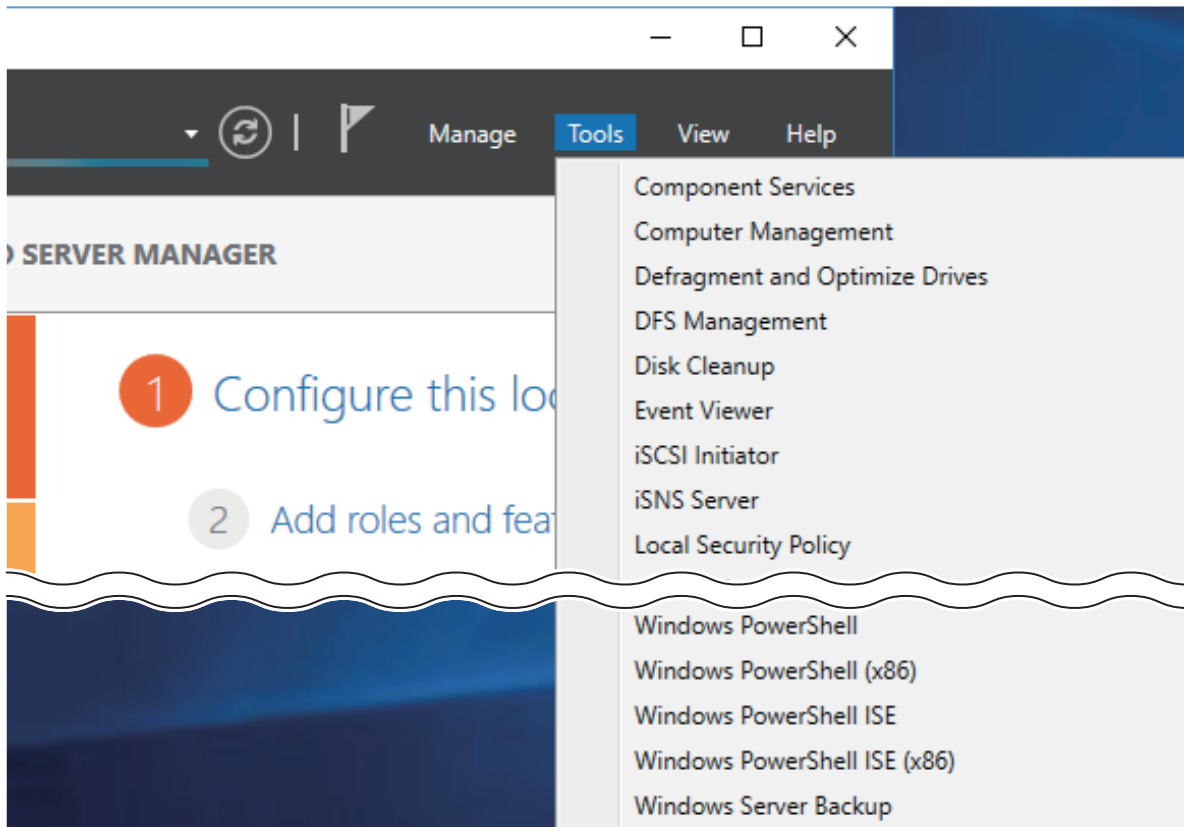

**2** Double-click *Windows Logs*.

**3** Right-click on either "Application", "Security", "Setup", or "System" in the left-side menu to determine the logs to be saved.

**4** Click *Save All Events As*.

**5** Specify the desired location and enter a filename, then click *Save*. Do not change the file type.

**6** When the "Display Information" screen appears, click *OK*.

The operation to acquire event logs is complete. Open the log file stored in the specified location to check the contents of the event logs.

# Configuring NIC Teaming

1 From Server Manager, click *Local Server*.

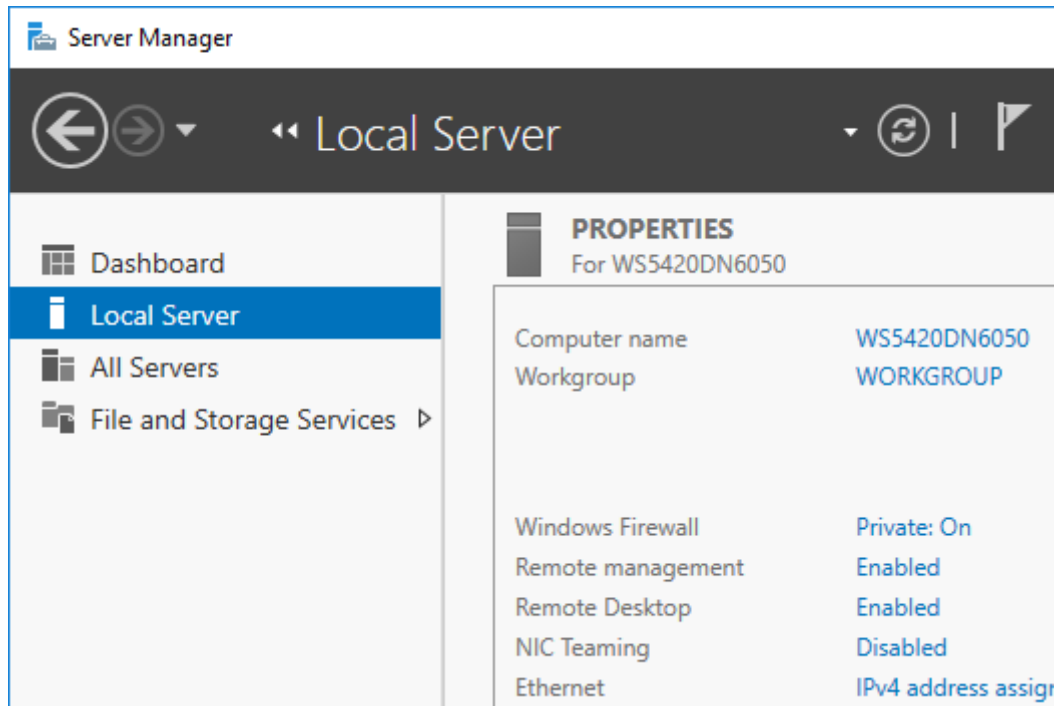

2 Click *Disabled* to the right of "NIC Teaming".

3 From the "TEAMS" field, click *TASKS*, then select *New Team*.

The screenshot shows the 'NIC Teaming' management console. At the top, there is a 'SERVERS' section with a table containing one server: WSS420DN6050, which is Online, Physical, and running Microsoft Windows Storage Server 2016 Standard. Below this is the 'TEAMS' section, which is currently empty. A 'TASKS' dropdown menu is open over the 'TEAMS' section, showing options: 'New Team', 'Delete', and 'Properties'. The 'New Team' option is highlighted. To the right of the 'TEAMS' section is the 'ADAPTERS AND INTERFACES' section, which shows a list of available adapters: Ethernet (1 Gbps), Ethernet 2 (Disconnected), and Ethernet 3 (Disconnected).

Name	Status	Server Type	Operating System Version	Teams
WSS420DN6050	Online	Physical	Microsoft Windows Storage Server 2016 Standard	0

  

Team	Status	Teaming Mode	Load B...
------	--------	--------------	-----------

Adapters	Team Interfaces	
Speed	State	Reason
▲ Available to be added to a team (3)		
Ethernet	1 Gbps	
Ethernet 2	Disconnected	
Ethernet 3	Disconnected	

**4** Enter a desired team name. Select the 1GbE adapters to join the team and click *OK*.

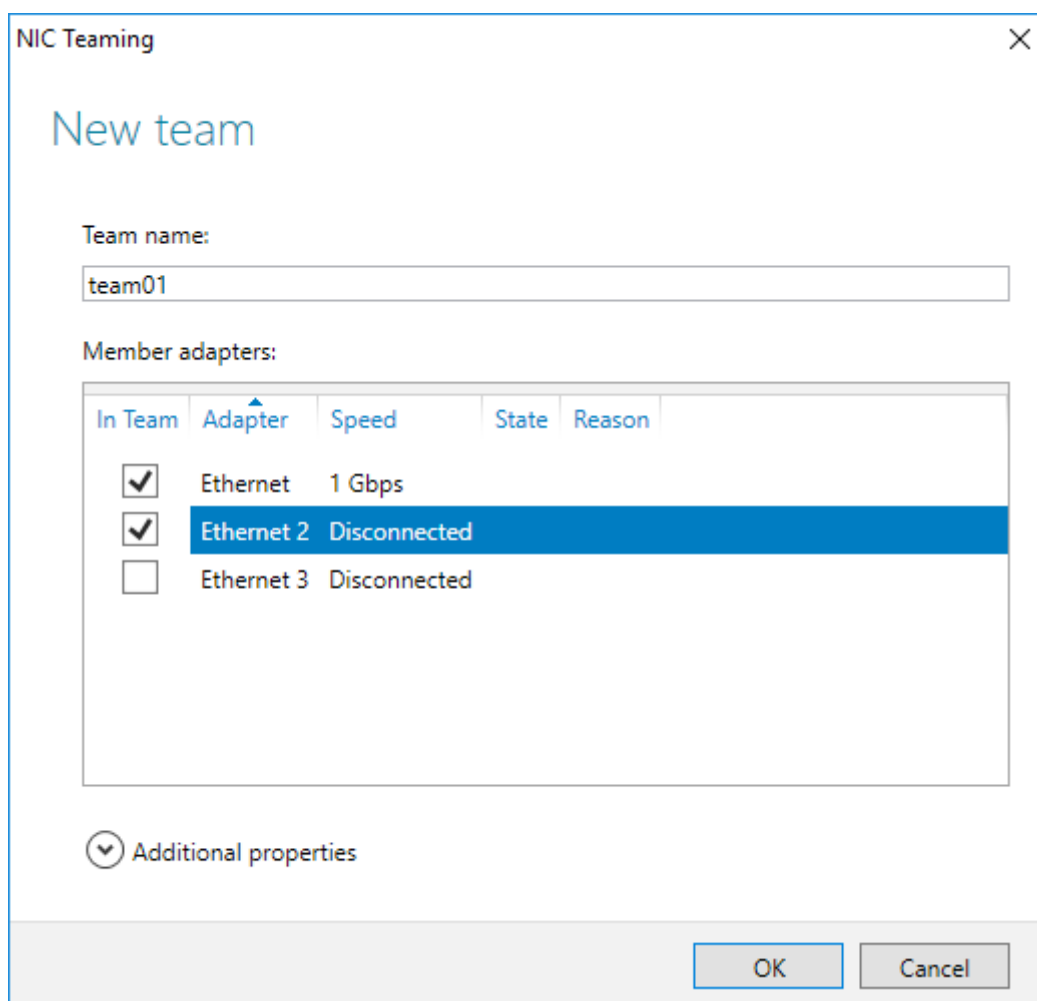

The created team will be added to the list. Wait until the status changes to "OK". It may take a few minutes.

---

## Enabling Wake-on-LAN

---

You can turn on the TeraStation via Wake-on-LAN. You can control the powered-down TeraStation remotely without moving to the unit nearby.

1 From Server Manager, click *Tools > Computer Management*.

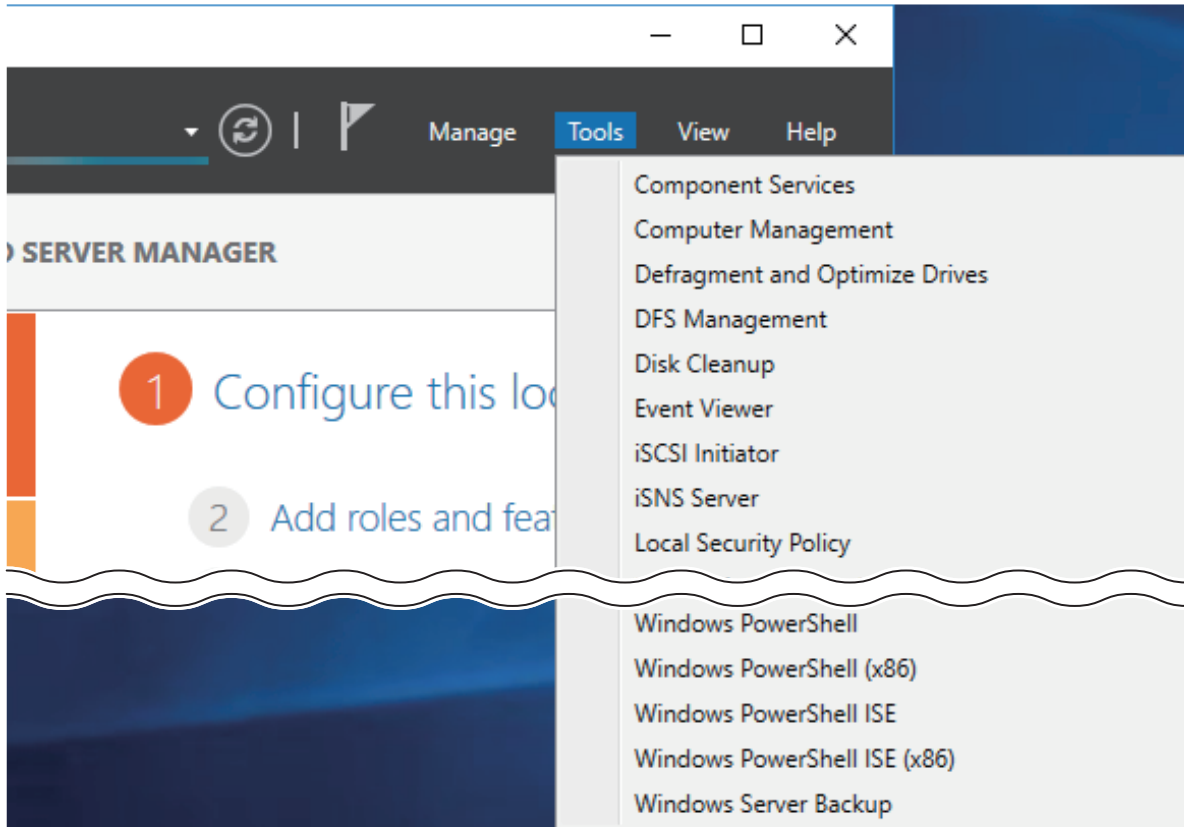

2 Click *Device Manager*.

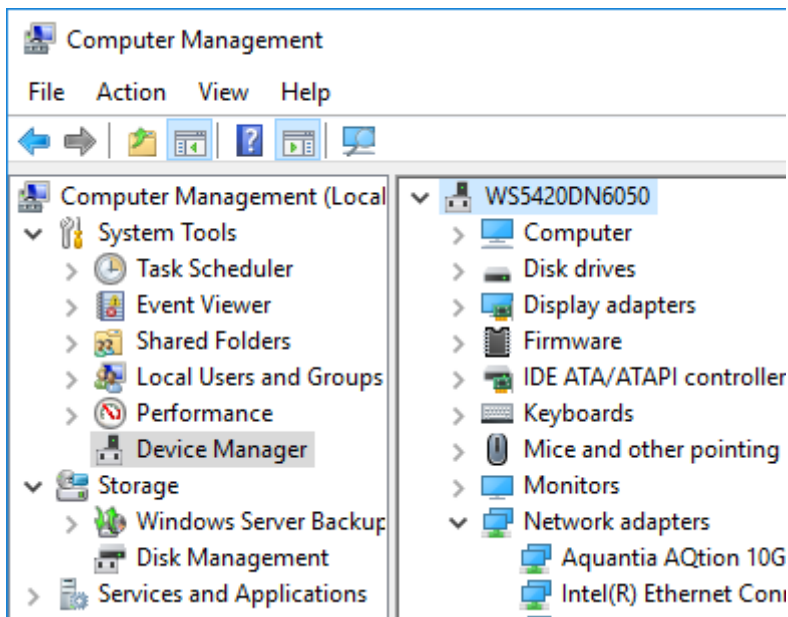

**3** Right-click the network adapter to use for Wake-on-LAN and click *Properties*.

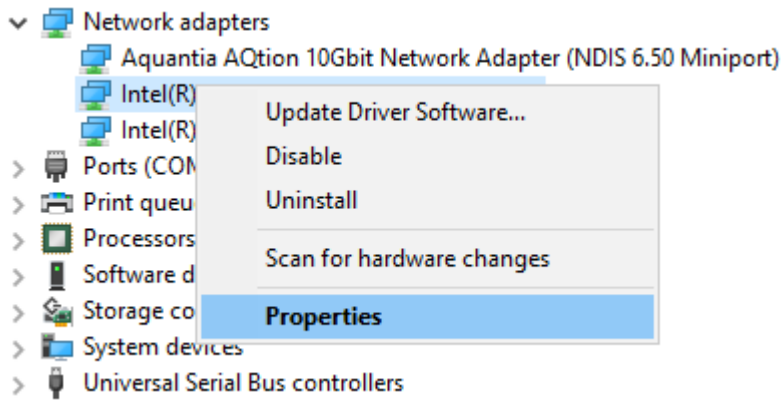

**4** Click the *Advanced* tab.

**5** If you use the 1GbE ports (LAN 1 or LAN 2), then select "Enable PME" under "Property" and change "Value" to "Enabled".

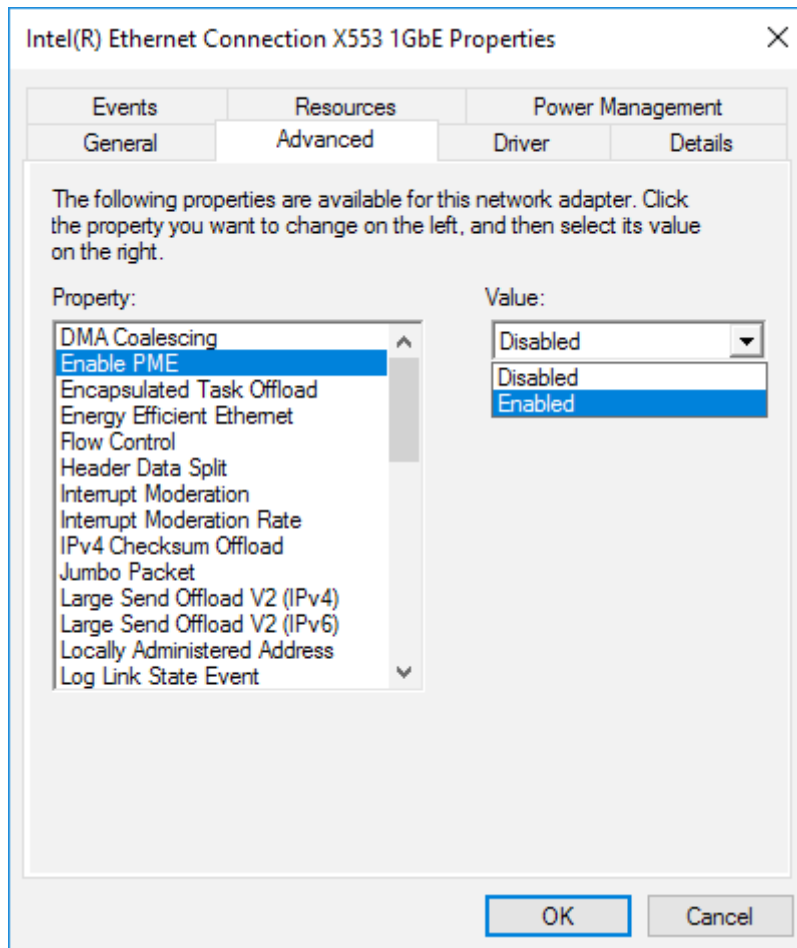



**6** For any adapters, select “Wake on Magic Packet” under “Property” and change “Value” to “Enabled”.

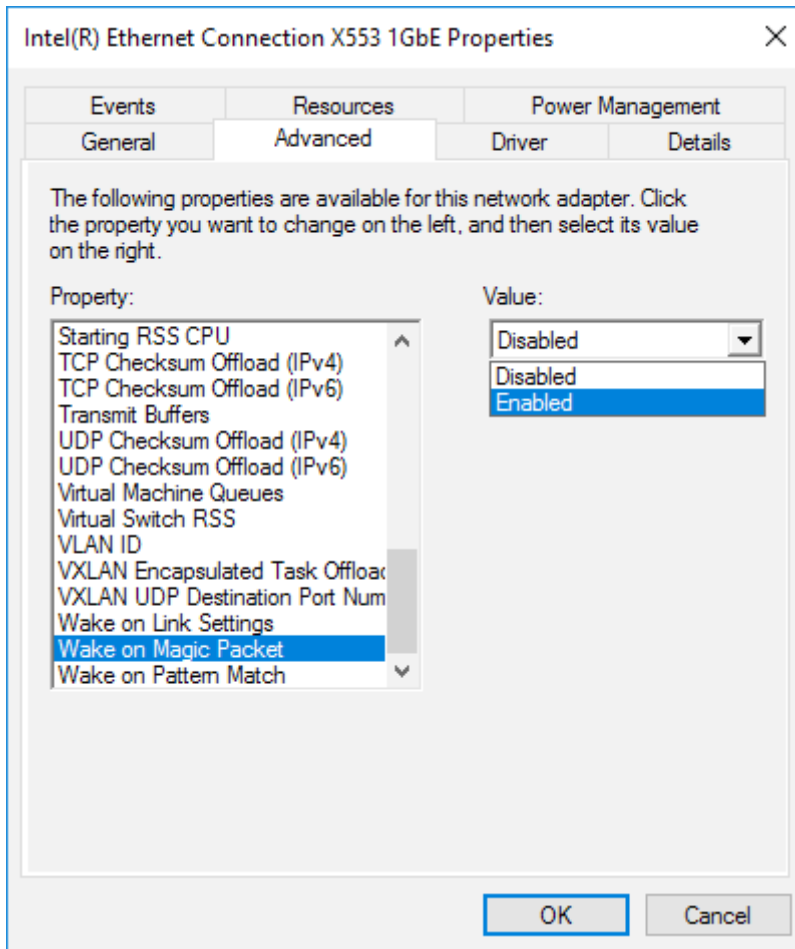

**Notes:**

- To use Wake-on-LAN, you'll need Wake-on-LAN software that sends magic packets. The TeraStation does not include Wake-on-LAN software.
- If the TeraStation is powered off by Wake-on-LAN using 10GbE ports (LAN3), the link speed will be fixed to 100 Mbps. To use with 10GbE ports, all network devices must be compatible with 100 Mbps speed.

# Chapter 6 Drive Replacement

## LEDs

Drives in the TeraStation show a green status LED during normal operation. If a drive fails, its error LED will glow red. The following drive replacement examples use the case of the WS5420DN6 series.

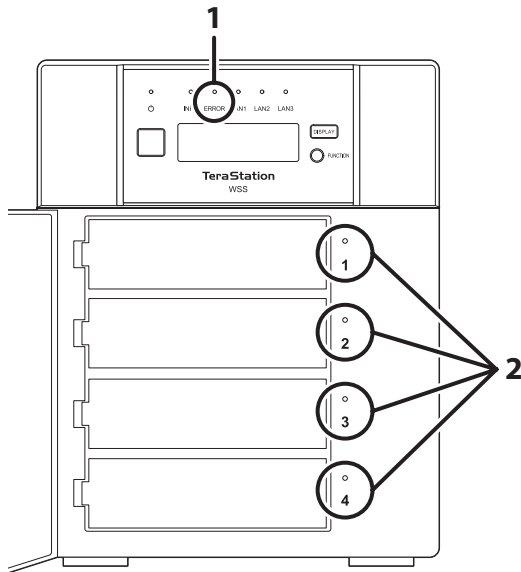

### 1 Error LED

Glowes red if a drive has failed.

### 2 Status LEDs

The failed drive's status LED will be glowing a steady red. Dismount the drive in Buffalo Dashboard before unplugging it from the TeraStation.

## Notice Before Drive Replacement

- Do not unplug a drive whose status LED is not lit red. If you remove the drive without properly dismounting it, data may be lost or the TeraStation may malfunction.
- For the replacement drive, use a Buffalo OP-HDN series drive. The new drive should be the same size or larger. If a larger drive is used, the extra space will not be usable in a volume.
- The TeraStation is fragile. Handle it with care. Do not drop or bump the TeraStation.
- Use caution when handling the unit in order to avoid personal injury.
- Never disassemble any parts while you are replacing a drive unless instructed to do so in this manual. Any malfunction or damage caused by disassembling the TeraStation will void your warranty.
- To avoid damaging the TeraStation with static electricity, ground yourself by touching something made of metal before handling any sensitive electronic parts.
- Do not change the order of the drives in the TeraStation. For example, pulling out drive 1 and replacing it with drive 2 may cause data to be corrupted or lost.

- The boot drive (C:) consists of the mirrored volume and a portion of the two drives from the top. Do not replace both of these drives at the same time.
- If a drive is replaced while saving a file, the file can be corrupted. Be sure that the saving operation is completed before replacing the drive.

---

## Example of Drives 1 and 2

---

### Notes:

- If one of the drives in the boot drive fails, repair the mirrored volume of the system area first after replacing the drive. Repairing the volume for the data area first may not always succeed.
- If you used Disk Management to mirror the boot drive, the TeraStation will not boot if the drive fails. In such a case, refer to the procedure below.

**1** If your TeraStation has a front cover, open it with the included key.

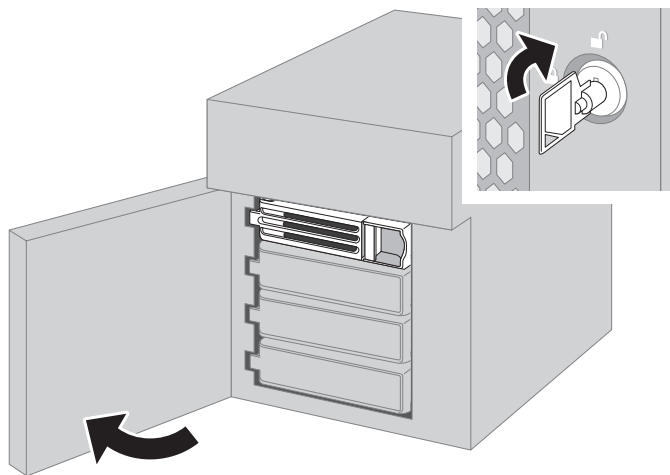

**2** Make a note of the drive number where the status LED glows red.

**3** Shut down the TeraStation.

**4** Push the unlock button of the failed drive and swing the lock mechanism out.

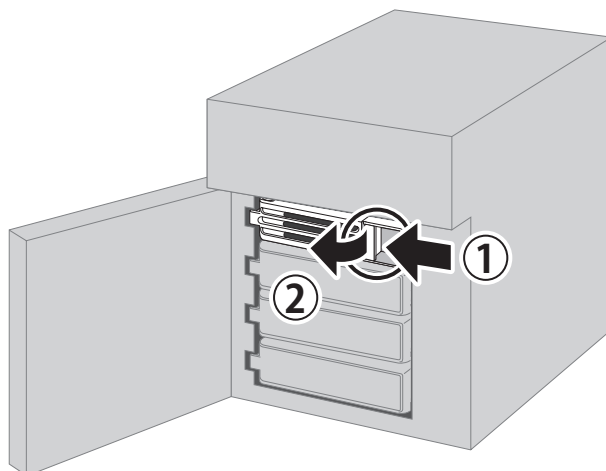

**5** Pull out the drive cartridge and remove it from the TeraStation.

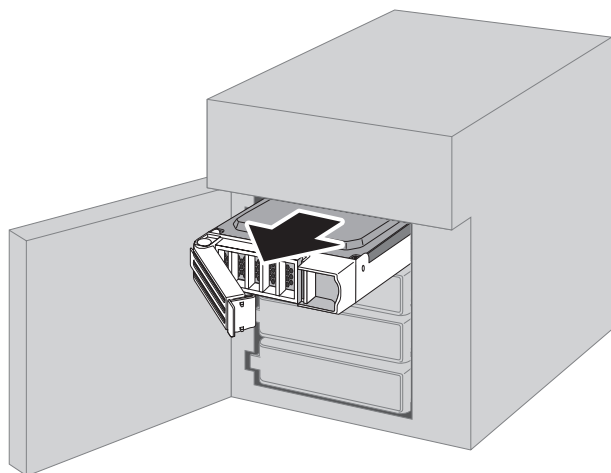

**6** Firmly insert the new drive into the empty slot. Slide the drive in with the locking mechanism open. Make sure the replacement drive is inserted exactly as the previous drive.

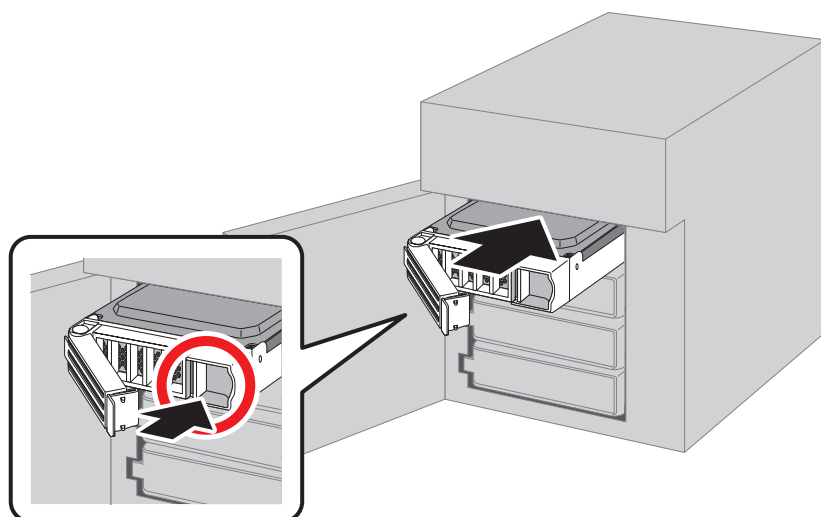

**7** Swing the lock back down until it clicks into place. Make sure that the inserted drive has been pushed in as far as the other drives. If the drive has not been inserted properly, it will not be detected by the TeraStation.

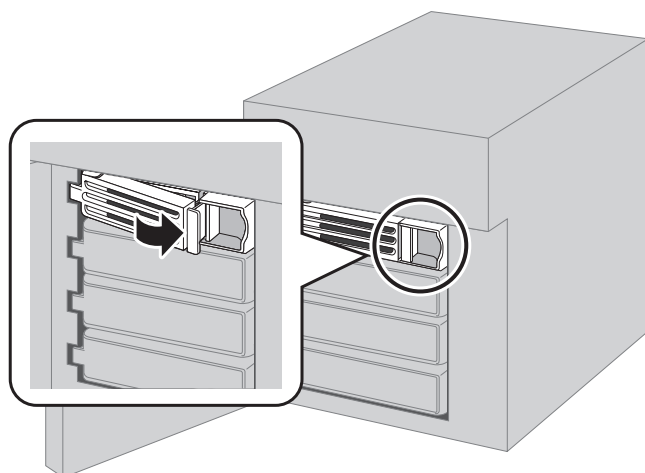

**8** Close the front cover with the included key. Press the power button on the TeraStation to turn it on.

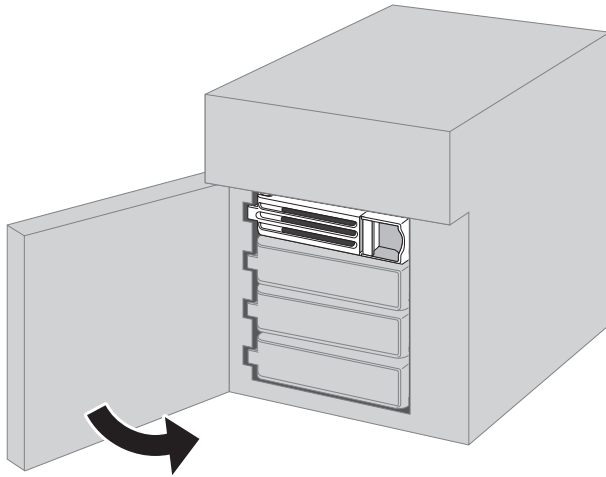

**9** Double-click the  icon to start NAS Navigator2.

**10** Right-click your TeraStation's icon and select *Open Remote Desktop*. For macOS, select the TeraStation's icon while holding down the control key, then select *Open Remote Desktop*.

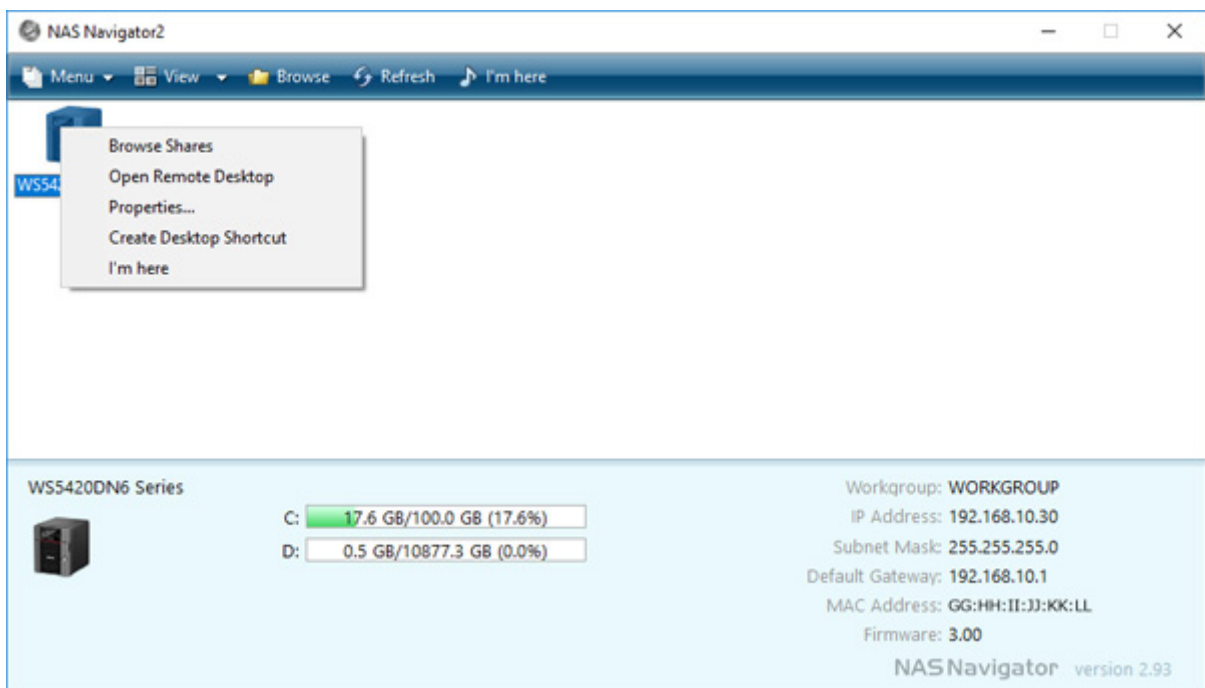

**11** Enter the username and password and press the Enter key. Windows Storage Server opens in the remote desktop.

**Note:** The default username and password are "Administrator" and "password".

**12** Click the Start button and click *RAID Builder*.

**13** Select *Create or repair a mirrored volume of the system area*, check the replaced drive, and click *OK*.

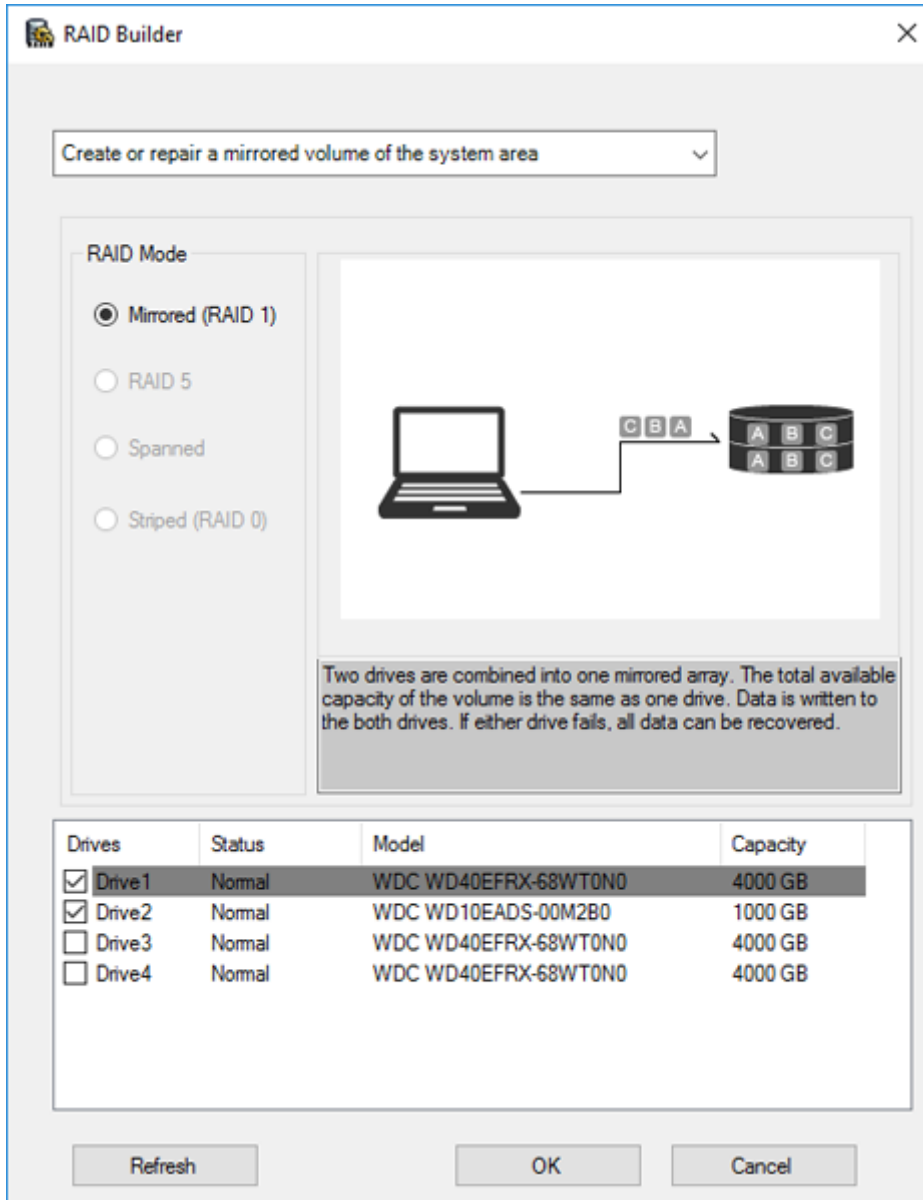

**14** When "Drive x will be initialized. Continue?" is displayed, click *OK*. It will take about an hour for the mirrored volume to be repaired. You can check the progress of the repair in Disk Management. After creating a mirrored volume, you will see the message dialog to restart your TeraStation. Follow the instructions displayed. When the reboot is finished, go to the next step.

**15** From Server Manager, click *Tools > Computer Management*.

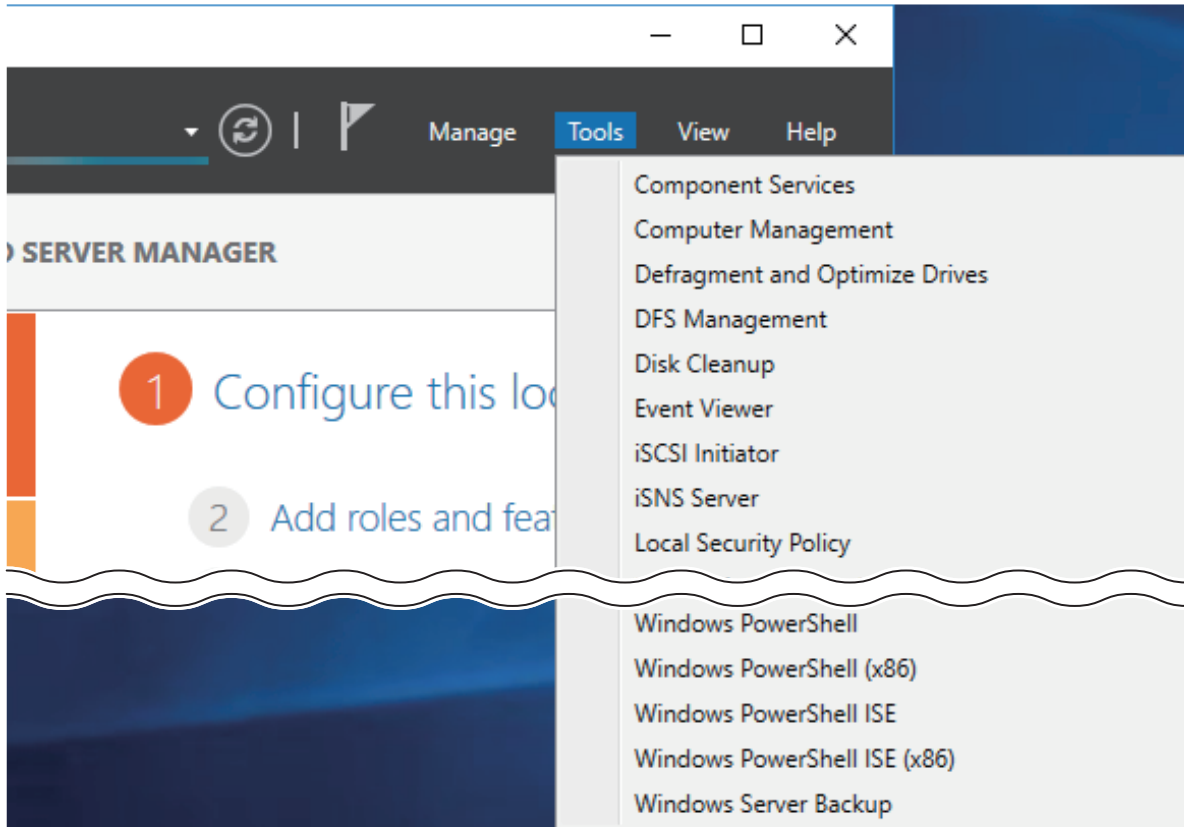

**16** Click *Disk Management*.

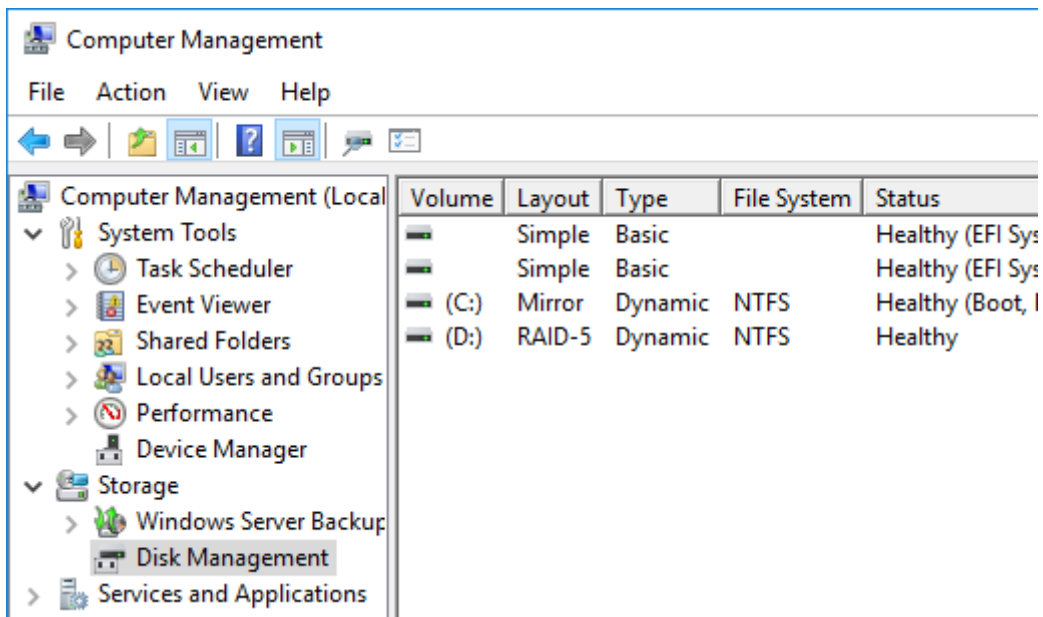

**17** Select the step depending on your reason for a created volume.

**To create a new volume (except for a RAID 5 volume or mirrored volume):**

- (1) Right-click the new dynamic disk and select *New Volume*.
- (2) Follow the instructions on the screen to create a new volume.

**To repair a RAID 5 volume:**

- (1) Right-click the volume labeled "Failed Redundancy" and click *Repair Volume*.
- (2) When "Select one of the disks listed below." is displayed, select the drive to repair and click *OK*.

Repeat steps (1) and (2) for each volume that requires resynchronization.

- (3) Right-click the volume labeled "Missing" and select *Remove Disk*.

**To repair a mirrored volume:**

- (1) Right-click the volume labeled "Failed Redundancy" and click *Remove Mirror*.
- (2) When "Remove Mirror" is displayed, select "Missing" and click *Remove Mirror*.
- (3) When "Are you sure you want to remove the mirror?" is displayed, click *Yes*.  
Repeat steps (1) to (3) for each volume that requires resynchronization.
- (4) Select the volume to be repaired and select *Add Mirror*.
- (5) When "Add Mirror" is displayed, select the drive to be added to the mirrored volume and click *Add Mirror*.

## If a Mirrored System Area Failed to Be Repaired

If a mirrored volume on the system area doesn't restore the first time, try initializing the drive and converting it to a dynamic disk, then restart the TeraStation. After the TeraStation restarts, try the steps above a second time. If the mirrored volume still cannot be restored, contact Buffalo technical support for assistance.

---

## Example of Drives 3 and 4

---



- 1 Double-click the  icon to start NAS Navigator2.

- 2 Right-click your TeraStation's icon and select *Open Remote Desktop*. For macOS, select the TeraStation's icon while holding down the control key, then select *Open Remote Desktop*.

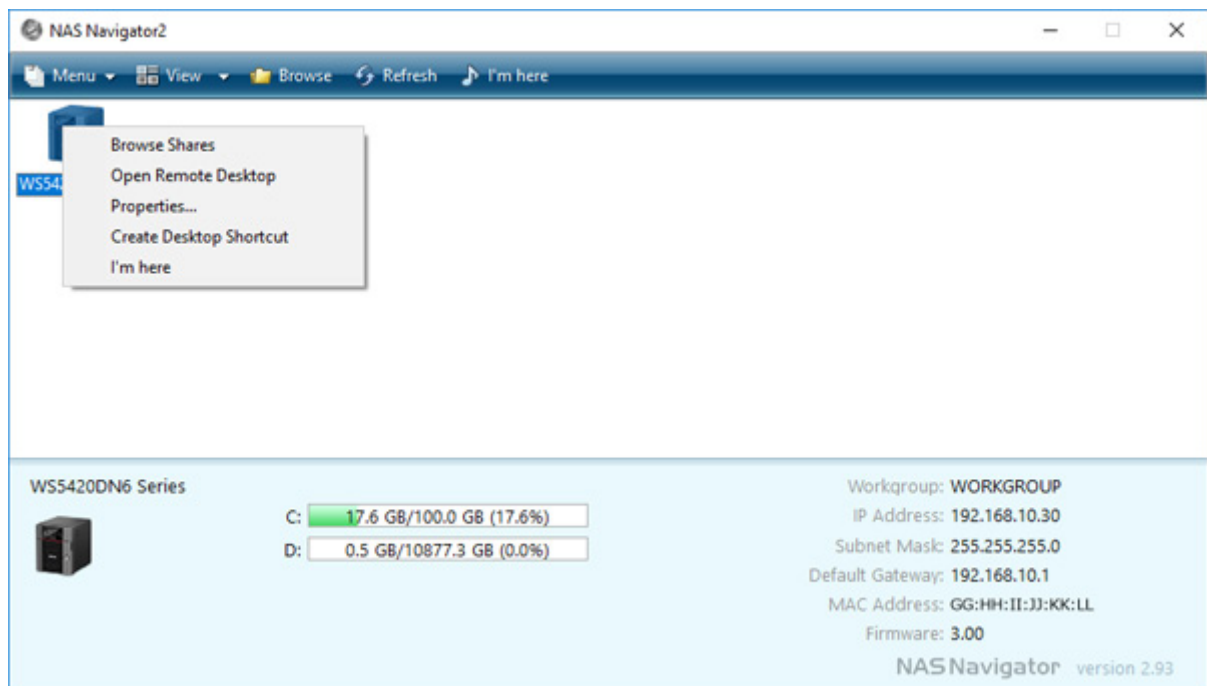

- 3 Enter the username and password, then press the Enter key. Windows Storage Server will open in the remote desktop.

**Note:** The default username and password are "Administrator" and "password".



- 4** The error message (E30) will be displayed in Buffalo Dashboard. Click *Dismount Drive x* (where “x” is the number of the failed drive).

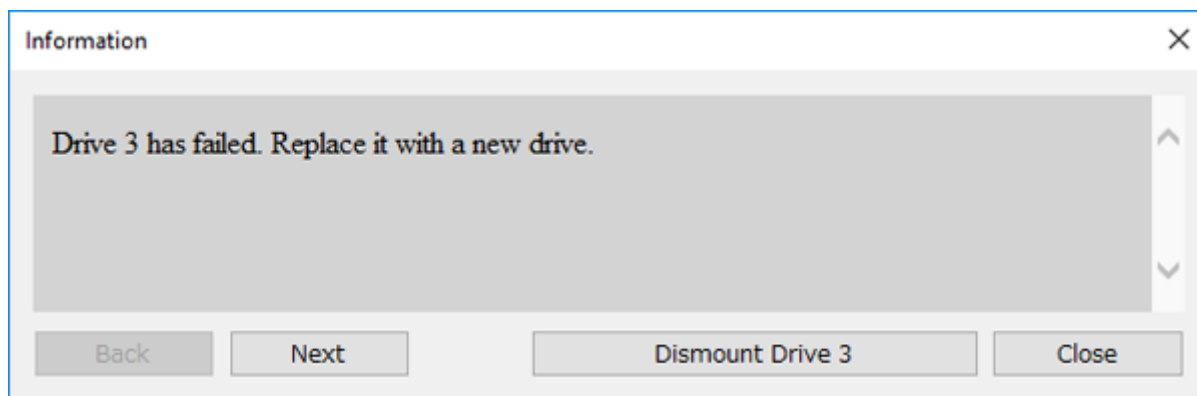

- 5** When the message “Drive dismount finished.” is displayed, click *OK*.  
The status LED will stop flashing and glow steadily.
- 6** If your TeraStation has a front cover, open it with the included key.
- 7** Push the unlock button of the failed drive and swing the lock mechanism out.
- 8** Pull out the drive cartridge and remove it from the TeraStation.
- 9** Firmly insert the new drive into the empty slot. Slide the drive in with the locking mechanism open. Make sure the replacement drive is inserted exactly as the previous drive.
- 10** Swing the lock back down until it clicks into place. Make sure that the inserted drive has been pushed in as far as the other drives. If the drive has not been inserted properly, it will not be detected by the TeraStation.
- 11** Close the front cover with the included key. If the drive was replaced while the TeraStation was off, power it on now.

**12** Buffalo Dashboard will show the drive status “Getting drive status...”. After the drive status changes to “Normal”, open Server Manager and click *Tools > Computer Management*.

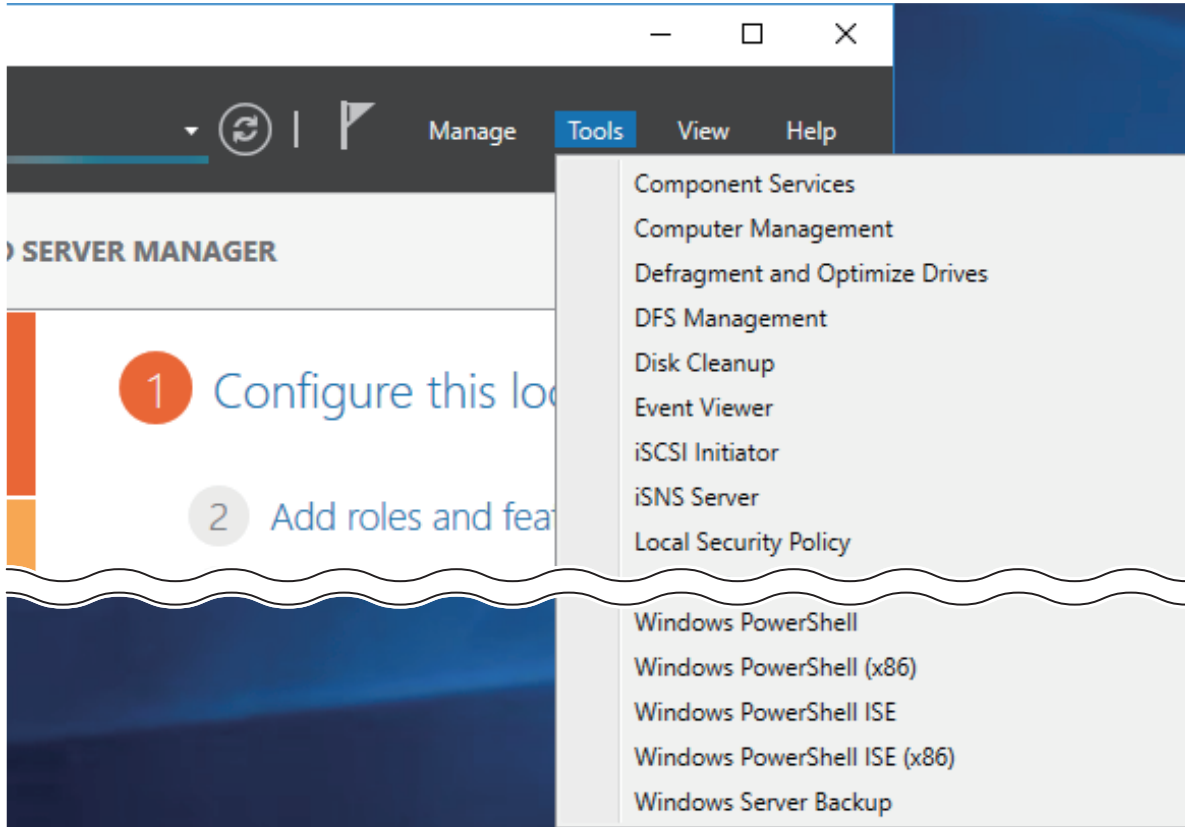

**13** Click *Disk Management*.

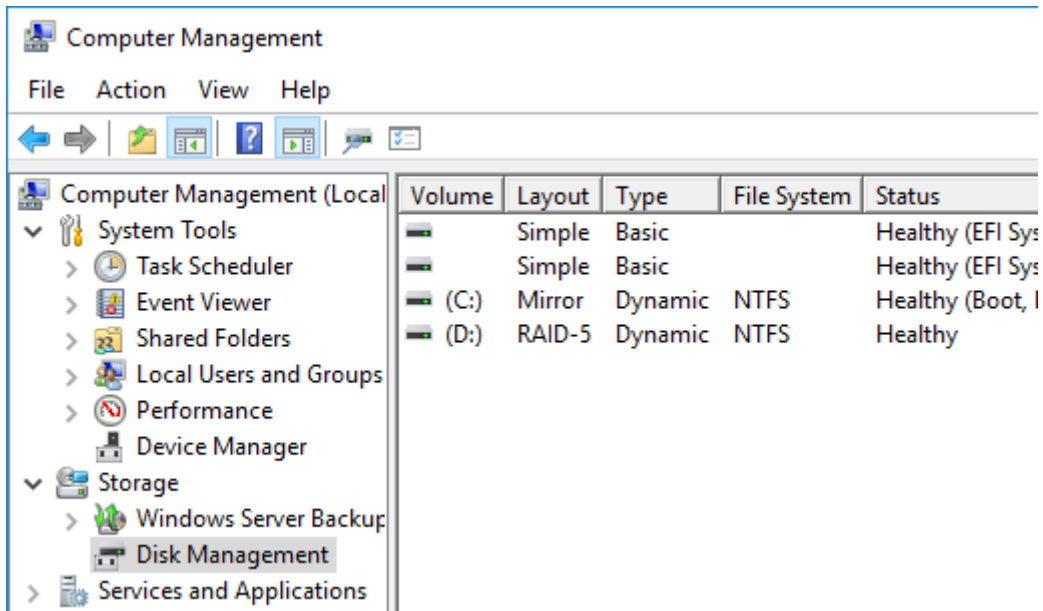

**14** When the “Initialize Disk” window appears, click *OK*.

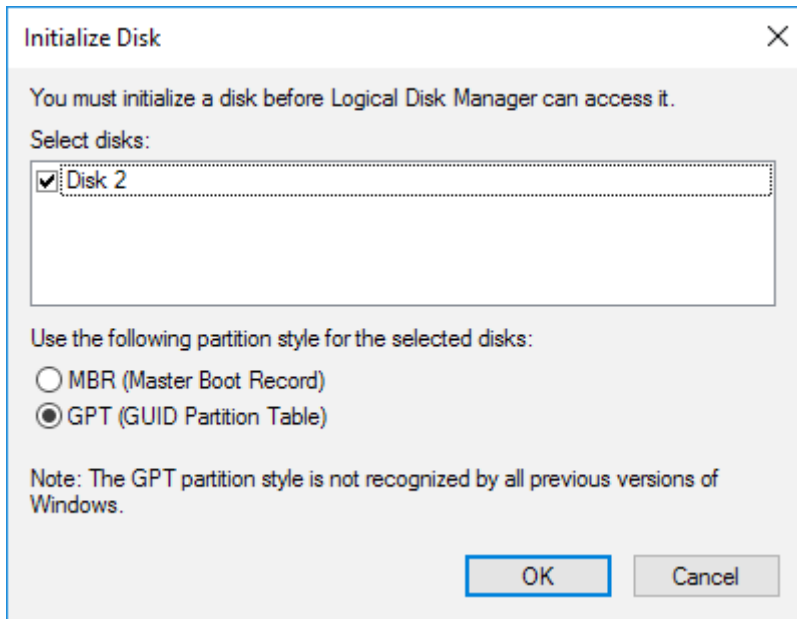

**15** Right-click the initialized drive and select *Convert to Dynamic Disk*. A volume cannot be created unless the drive is converted to a dynamic disk.

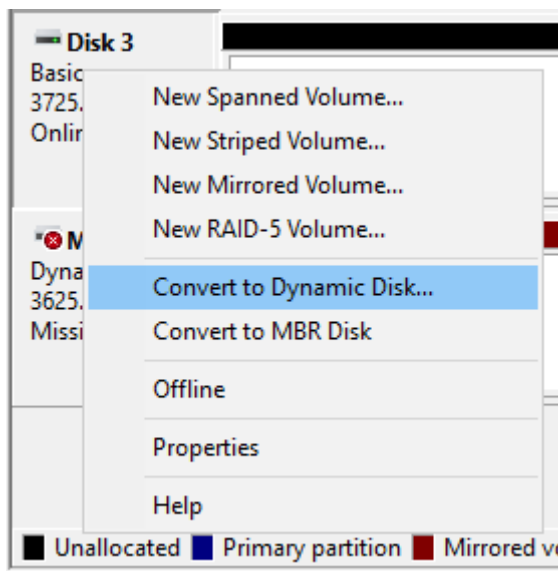

**16** Select the step depending on your reason for a created volume.

**To create a new volume (except for a RAID 5 volume or mirrored volume):**

- (1) Right-click the new dynamic disk and select *New Volume*.
- (2) Follow the instructions on the screen to create a new volume.

**To repair a RAID 5 volume:**

- (1) Right-click the volume labeled “Failed Redundancy” and click *Repair Volume*.
- (2) When “Select one of the disks listed below.” is displayed, select the drive to repair and click *Yes*. Repeat steps (1) and (2) for each volume that requires resynchronization.
- (3) Right-click the volume labeled “Missing” and select *Remove Disk*.

**To repair a mirrored volume:**

- (1) Right-click the volume labeled “Failed Redundancy” and click *Remove Mirror*.
- (2) When “Remove Mirror” is displayed, select “Missing” and click *Remove Mirror*.

- (3) When "Are you sure you want to remove the mirror?" is displayed, click *Yes*. Repeat steps (1) to (3) for each volume that requires resynchronization.
- (4) Select the volume to be repaired and select *Add Mirror*.
- (5) When "Add Mirror" is displayed, select the drive to be added to the mirrored volume and click *Add Mirror*.

# Chapter 7 Utilities

## NAS Navigator2 for Windows

NAS Navigator2 is a utility program that makes it easy to display Windows Storage Server, change the TeraStation's IP address, or check its drive in remote desktop. To install NAS Navigator2, download the installer from <http://d.buffalo.jp/WS5020N6/>.



Double-click the  icon to start NAS Navigator2.

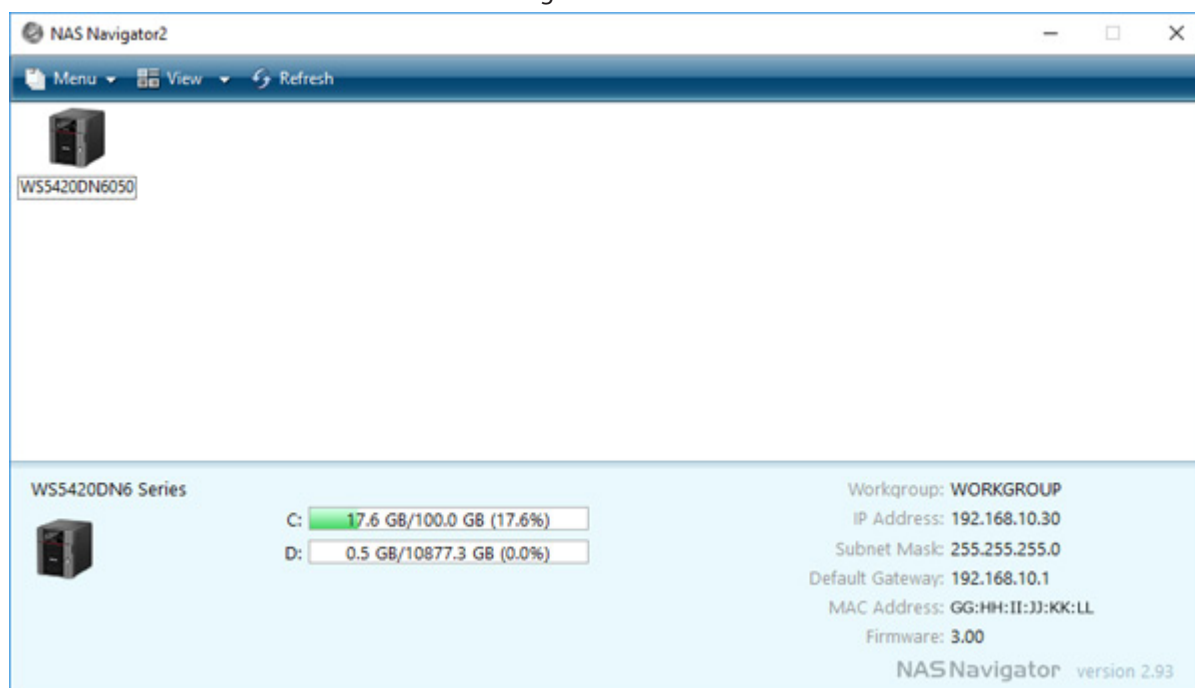

Click on a TeraStation's icon to display:

- Total capacity
- Used capacity
- Workgroup
- IP address
- Subnet mask
- Default gateway
- MAC address
- Firmware version

Double-click the icon to open a share on the TeraStation.

Name		Description
Menu	Map All Remote Shares to Drive Letters	Assigns all Buffalo NAS devices' shared folders as network drives. This is available only when a shared folder has been created.
	Create Desktop Shortcut*	Creates a desktop shortcut to the Buffalo NAS device's shared folders.
	Launch NAS Navigator2 on Startup	Launches NAS Navigator2 in the system tray when Windows boots.
	Display Errors	If an error occurs, an error message will appear from the NAS Navigator2 icon in the system tray.
	Properties*	Opens the properties page that lets you configure the Buffalo NAS device's IP address or open Windows Storage Server in remote desktop.
	Close	Closes NAS Navigator2.
View	View	Icons: Displays icons. Details: Displays the hostname, product name, workgroup, IP address, subnet mask, and default gateway.
	Sort by	If you have multiple Buffalo NAS devices on the network, you may choose to display them in order of hostname, product name, workgroup, IP address, subnet mask, or default gateway.
Browse*		Opens the Buffalo NAS device's shared folders.
Refresh		Searches for the Buffalo NAS devices on the network again.
I'm here*		Causes your Buffalo NAS device to beep.
Right-click your device's icon to show these options.	Browse Shares	Opens the Buffalo NAS device's shared folders.
	Open Remote Desktop	Opens Windows Storage Server in remote desktop.
	Properties	Opens the properties page that lets you configure the Buffalo NAS device's IP address or open Windows Storage Server in remote desktop.
	Create Desktop Shortcut	Creates a desktop shortcut to the Buffalo NAS device's shared folders.
	I'm here	Causes your Buffalo NAS device to beep.

\*Click on the Buffalo NAS device's icon to display these options.

When NAS Navigator2 is closed, right-click the NAS Navigator2 icon in the system tray for the following options.

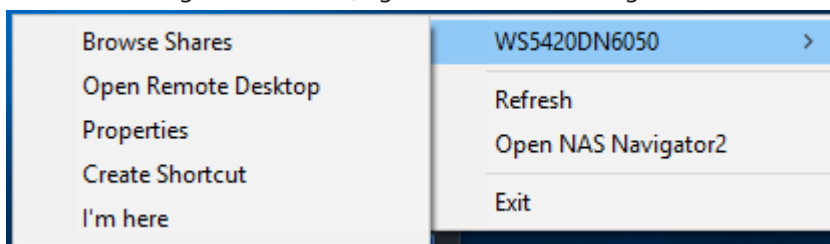

Name	Description	
Buffalo NAS device name	Browse Shares	Opens the Buffalo NAS device's shared folders.
	Open Remote Desktop	Opens Windows Storage Server in remote desktop.
	Properties	Opens the properties page that lets you configure the Buffalo NAS device's IP address or open Windows Storage Server in remote desktop.
	Create Shortcut	Creates a desktop shortcut to the Buffalo NAS device's shared folders.
	I'm here	Causes your Buffalo NAS device to beep.
Refresh	Searches for the Buffalo NAS devices on the network again.	
Open NAS Navigator2	Opens the NAS Navigator2 window.	
Exit	Exits NAS Navigator2.	

The following tasks may be performed from the Buffalo NAS device's properties page.

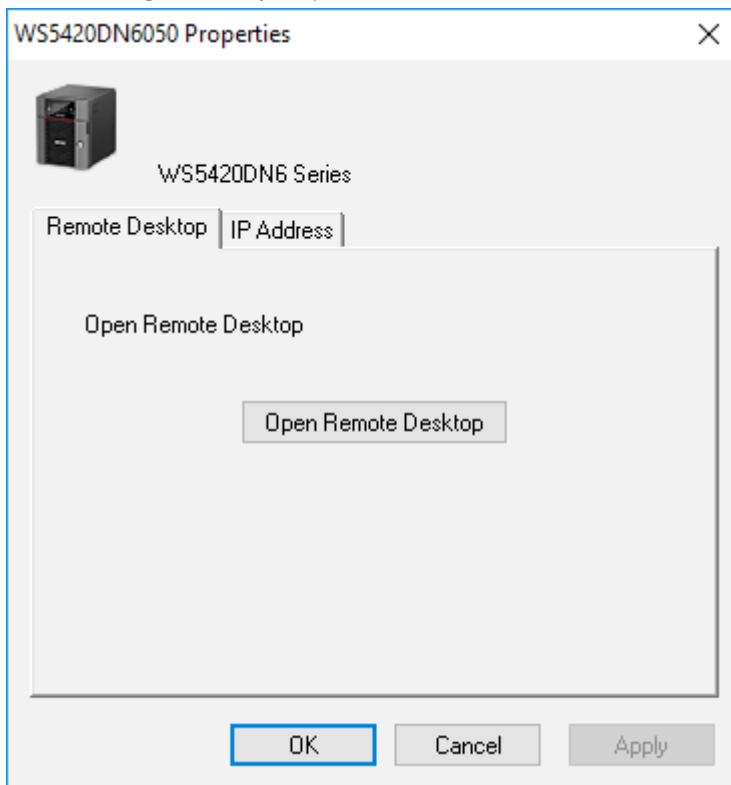

Name	Description
Remote Desktop	Click <i>Open Remote Desktop</i> to open Windows Storage Server.
IP Address	Select the "Use DHCP" checkbox to assign an IP address from the DHCP server automatically. If there is no DHCP server on the network, you cannot use this function. Select the "Renew IP address" checkbox to obtain an IP address from the DHCP server. You can manually enter an IP address, subnet mask, and default gateway.

## Changing the IP Address

**1** Double-click the  icon to start NAS Navigator2.

**2** Right-click your TeraStation's icon and select *Properties > IP Address*.

- 3 Clear the "Use DHCP" checkbox and enter the desired settings, then click *OK*. If the username and password prompt appears, enter the admin username and password.

## NAS Navigator2 for Mac

NAS Navigator2 is a utility program that makes it easy to display Windows Storage Server, change the TeraStation's IP address, or check its drive in remote desktop. To install NAS Navigator2, download the installer from <http://d.buffalo.jp/WS5020N6/>.



Click the icon in the Dock to start NAS Navigator2.

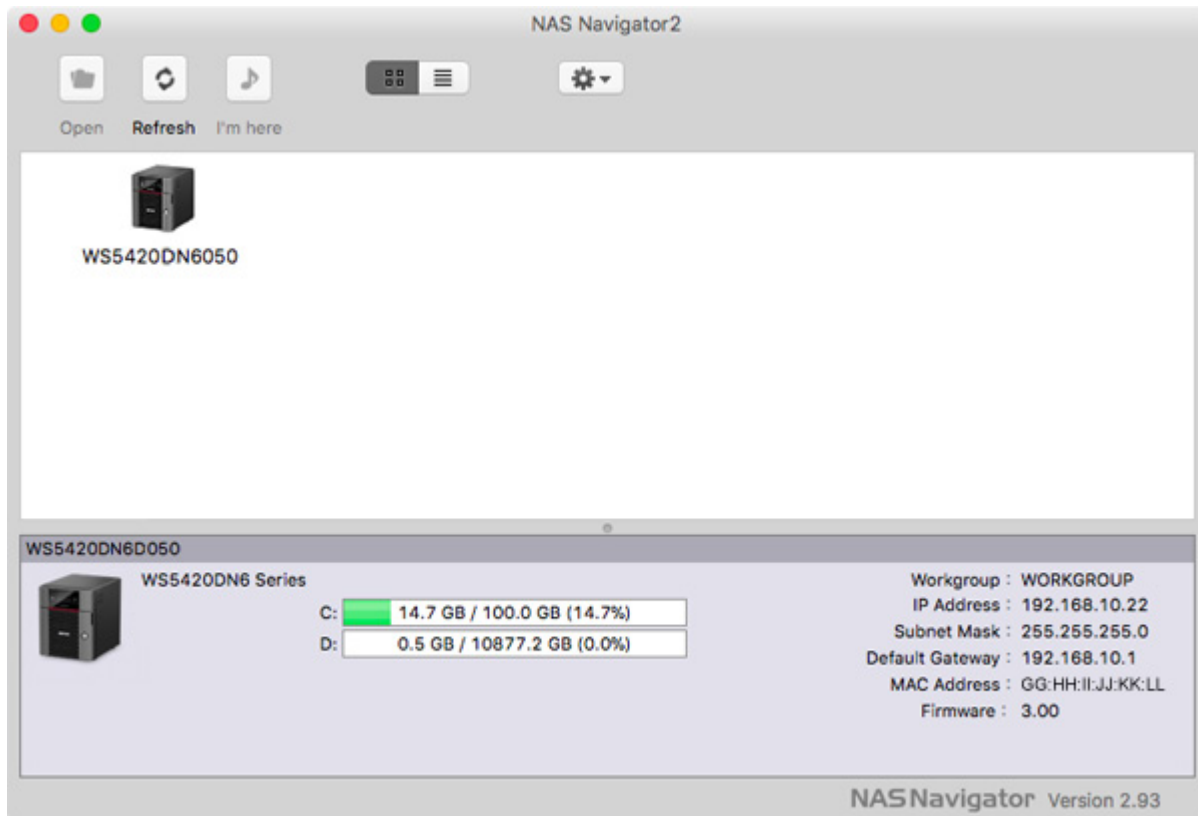

Click on a TeraStation's icon to display:

- Total capacity
- Used capacity
- Workgroup
- IP address
- Subnet mask
- Default gateway
- MAC address
- Firmware version

Double-click the icon to open a share on the TeraStation.

Name	Description
Open	Opens the Buffalo NAS device's shared folders.
Refresh	Searches for the Buffalo NAS devices on the network again.
I'm here	Causes your Buffalo NAS device to beep.



Name	Description	
Open Remote Desktop	Opens Windows Storage Server in remote desktop.	
Configure	Opens the properties page that lets you configure the Buffalo NAS device's IP address or open Windows Storage Server in remote desktop.	
Label Color	Selects the color of the name displayed below the icon.	
View Options	Lets you choose icon size, position, and view mode.	
Auto Power Mode	Auto power mode can turn supported Buffalo NAS devices on the network on and off automatically.	
To display these options, hold down the control key and click your device's icon.	Open Folder	Opens the Buffalo NAS device's shared folders.
	Open Remote Desktop	Opens Windows Storage Server in remote desktop.
	Configure	Opens the properties page that lets you configure the Buffalo NAS device's IP address or open Windows Storage Server in remote desktop.
	I'm here	Causes your Buffalo NAS device to beep.
	Label Color	Selects the color of the name displayed below the icon.

The following tasks may be performed from the Buffalo NAS device's properties page.

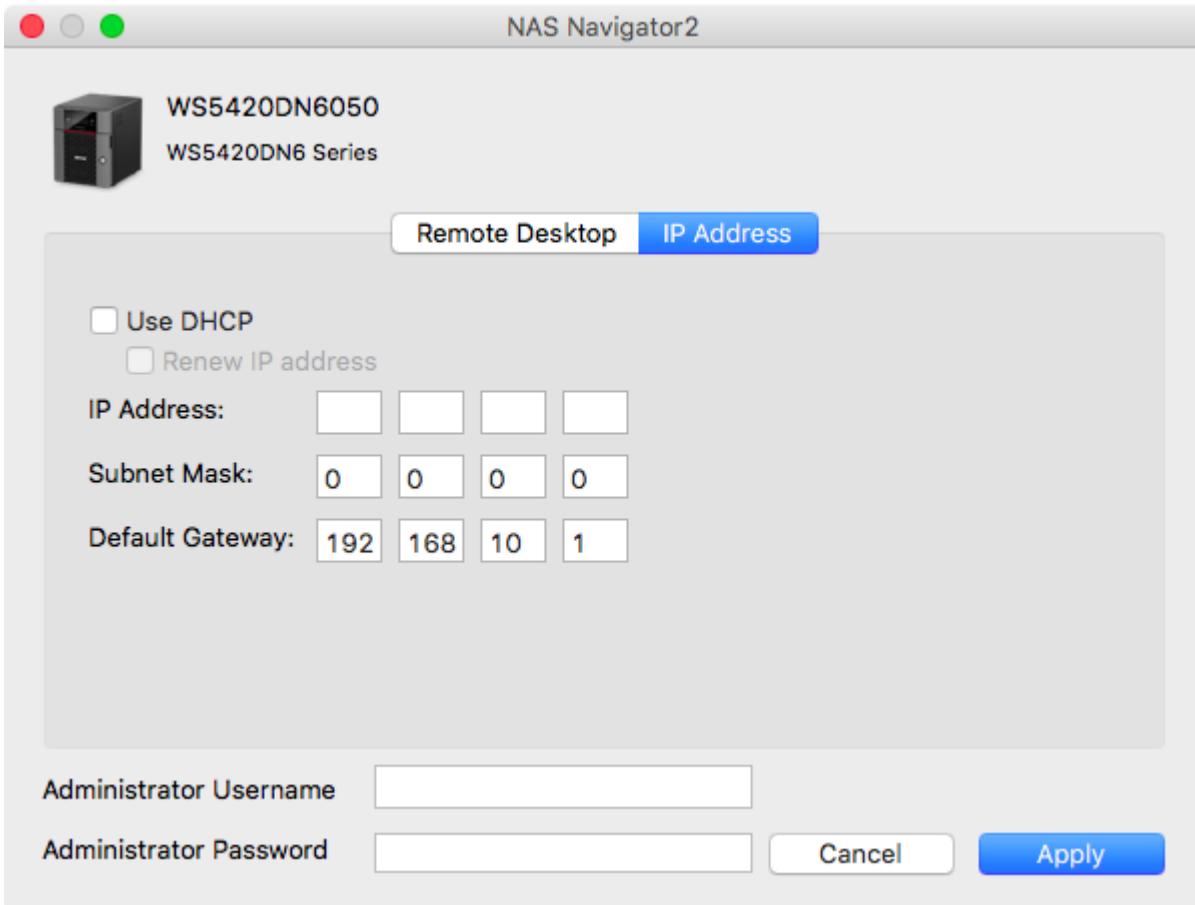

Name	Description
Remote Desktop	Click <i>Open Remote Desktop</i> to open Windows Storage Server.
IP Address	Select the "Use DHCP" checkbox to assign an IP address from the DHCP server automatically. If there is no DHCP server on the network, you cannot use this function. Select the "Renew IP address" checkbox to obtain an IP address from the DHCP server. You can manually enter an IP address, subnet mask, and default gateway.

## Changing the IP Address

---



- 1** Click the  icon in the Dock to start NAS Navigator2.
- 2** Click the TeraStation icon while holding down the control key, then choose *Configure > IP Address*.
- 3** Clear the “Use DHCP” checkbox; enter the desired settings and the administrator password, then click *Apply*.

---

## NovaBACKUP

---

NovaBACKUP is a Windows utility that lets you back up the data on your computer.

The NovaBACKUP installer is available from <http://d.buffalo.jp/WS5020N6/>. Select the region and model to go to your specific model’s d.buffalo website. Download the NovaBACKUP installer and install it onto your computer.

To download the installer, you will need the serial number of your TeraStation. The serial number is printed on the label on the back or top of the unit. For the rackmount model, the serial number is located on the front as well. Refer to the “Diagrams” section in chapter 1 for information on where to find the serial number.

# Chapter 8 Troubleshooting

While using the TeraStation, you may lose your important data due to sudden accidents, hard disk failure, or accidental misoperation. Back up your data regularly! For best results, back up your data to Buffalo drives like the TeraStation, LinkStation, or DriveStation series.

---

## The TeraStation Becomes Unaccessible

---

Common causes of typical issues that may occur, including if you are unable to search using NAS Navigator2 or the remote desktop screen does not open, are described below.

**Cause 1. The cables are not connected correctly:**

The cables are not physically connected, or there may be a contact defect. Reconnect the AC cable and Ethernet cable and restart both the computer and TeraStation.

**Cause 2. Security software in the background is blocking communication:**

Add an exception to your firewall software, or disable the firewall software completely. Turn off any software security suite that might include a firewall. Try searching again.

**Cause 3. Wireless and wired adapters are both enabled:**

Disable all adapters except for the Ethernet adapter connected to the TeraStation.

**Cause 4. The Ethernet cable is defective, or the connection is unstable:**

Try changing the hub port or Ethernet cable that you used to connect.

**Cause 5. The LAN board, card, or adapter that you are using is defective:**

Try changing the LAN board, card, or adapter.

**Cause 6. The duplex mode of the network adapter or hub has not been set to auto negotiation:**

Select the auto negotiation for the duplex mode of the network adapter or hub.

**Cause 7. A network bridge is installed:**

If the network has a network bridge that is not being used, remove it.

**Cause 8. You are searching from a different network:**

You cannot conduct searches beyond your local network subnet. Connect the TeraStation to the same network subnet as the computer performing the search.

**Cause 9. TCP/IP is not operating correctly:**

Reinstall the LAN adapter drivers.

### Cause 10. Remote desktop connection software is not installed on your Mac:

If using macOS, download and install “Microsoft Remote Desktop” from the Mac App Store.

---

## Shared Folders Suddenly Do Not Open

---

If the TeraStation shared folder is assigned and used as a network drive, the TeraStation may suddenly become inaccessible if network settings such as IP addresses or groups are changed. If this happens, open NAS Navigator2 and double-click your TeraStation icon to access a shared folder.

---

## Unable to Access the Shared Folder or the System Becomes Unstable

---

This usually happens because too many software applications are running on Windows Storage Server, causing a memory shortage. Exit or uninstall some of the software running on Windows Storage Server, then restart the TeraStation.

---

## I12 Message Appears Despite No Drive Errors

---

If the I12 message appears on the LCD panel (or NAS Navigator2) but the E30 message does not, this indicates that no drive errors actually occurred. The procedure below will vary depending on how seriously the RAID volume is corrupted. To check the volume status, follow the procedure below.

- 1 From Server Manager, click *Tools > Computer Management*.

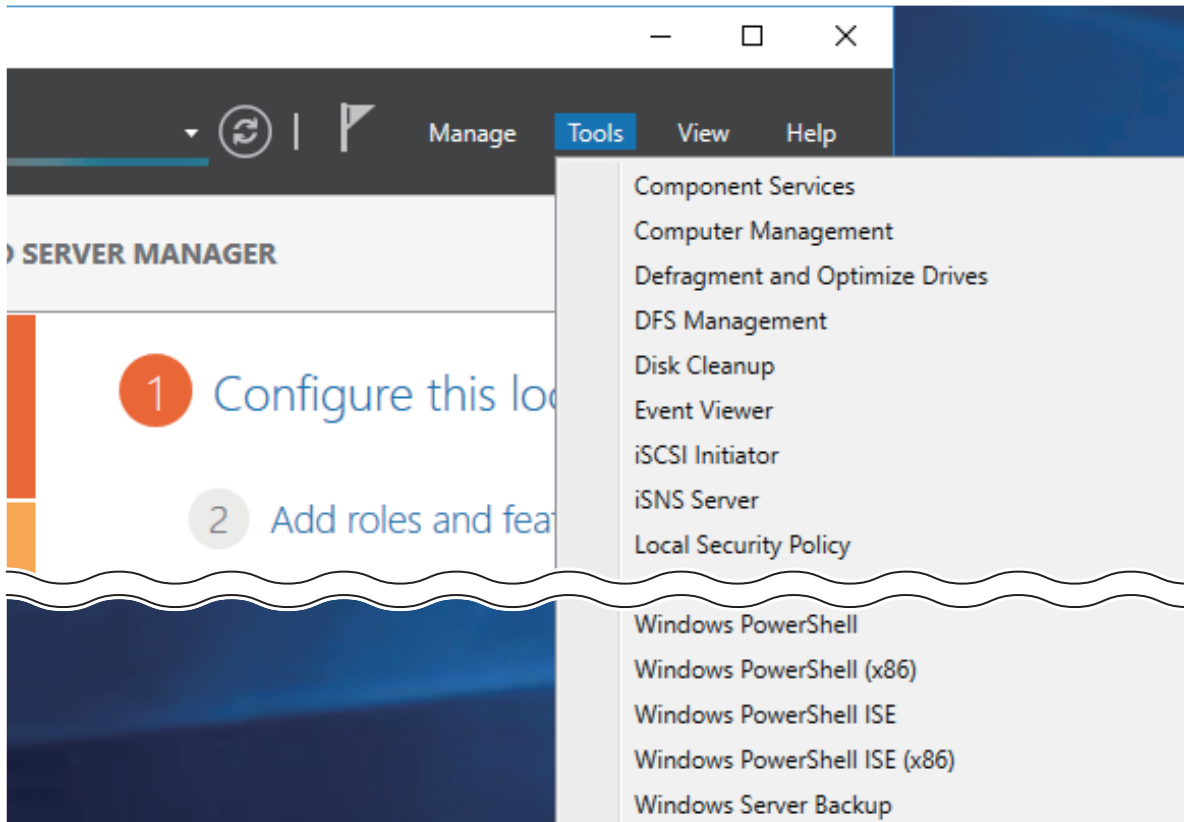

2 Click *Disk Management*.

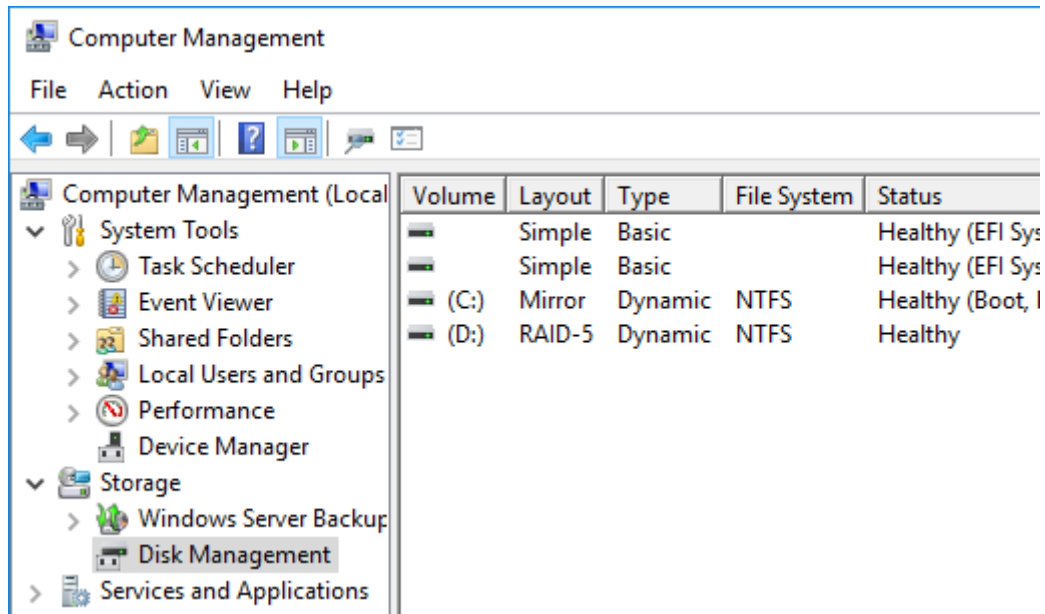

3 Check whether the volume status shows either “Failed Redundancy” or “Failed”.

### Status Shows “Failed Redundancy”

If the status shows “Failed Redundancy”, then a volume in the RAID volume has been corrupted and the RAID volume is operating in degraded mode. In such a case, right-click the volume labeled “Failed Redundancy” and click *Reactivate Volume* in Disk Management.

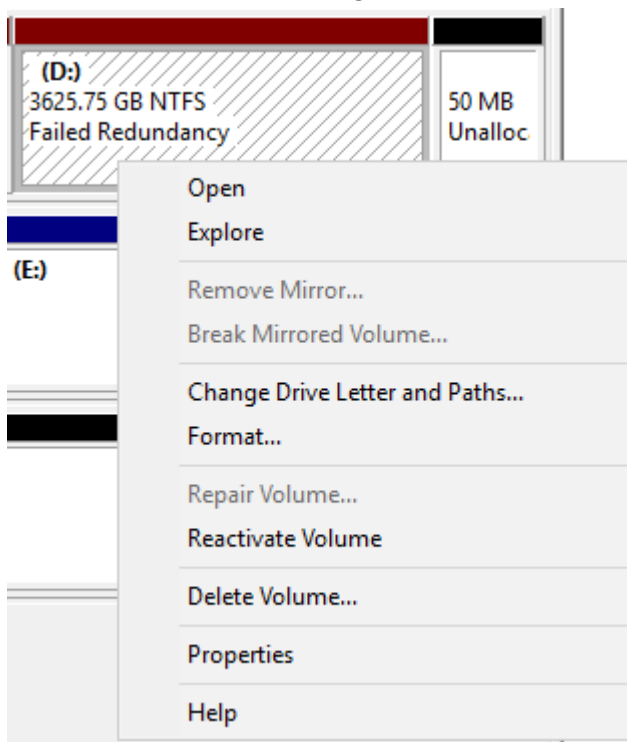

When you reactivate the volume, resynchronization will run automatically. File transfers and system performance will be slower while resynchronization is running, which will take about 23 hours for a RAID 5 volume and about 2–3 hours for a mirrored volume per a 4 TB TeraStation model.

## Status Shows “Failed”

If the two or more volumes are corrupted, the volume status will show “Failed” and the TeraStation will not be accessible. Data cannot be recovered. In such a case, right-click the volume labeled “Failed” and click *Delete Volume* in Disk Management.

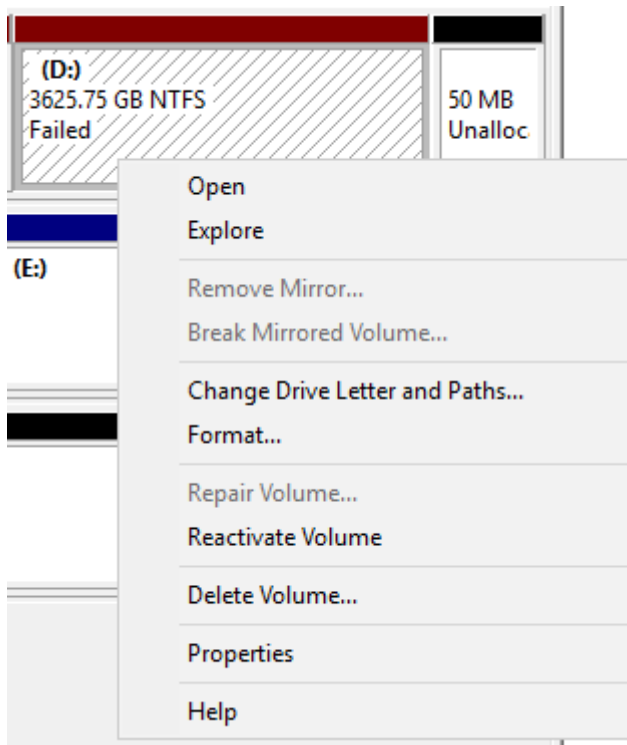

After the volumes are deleted, create the desired RAID volume. Refer to chapter 3 for information on working with volumes.

---

## TeraStation Does Not Boot

---

If Windows Storage Server no longer functions properly, perform recovery using the supplied SD card. This recovery procedure erases your data. Backing up regularly is highly recommended to avoid losing your important data.

### Notice Before Recovery

---

**Do not connect the SD card to another TeraStation or your computer. The recovery process that involves using this SD card is intended for this product only.**

Recovery is performed by deleting the area for drive 1, setting up a new 100 GB (Basic Disk/Simple) area, and then copying the Windows Storage Server image to this area.

If there are system areas (or mirrored locations) on the drives other than drive 1, be sure to delete the system areas (or disable the mirrored locations) before performing the recovery procedure. If recovery is performed without deleting these areas, Windows Storage Server may not run after recovery is performed.

If Windows Storage Server fails to run, turn off the TeraStation and perform the recovery procedure again while all hard drives except for drive 1 (disk 0) are disconnected. After recovery is complete, reconnect the disconnected drives, which will appear in Disk Management as “Foreign”. From Disk Management, right-click *Foreign*, select *Import Foreign Disks*, then right-click this area and click *Reactivate Volume* to rebuild the RAID volume.

## Recovering Windows Storage Server

---

- 1 Turn off the TeraStation, following the procedure on the “Turning the TeraStation On and Off” section in chapter 1.

- 2** Insert the SD card into the card reader (not included).
- 3** Connect the card reader to the USB port on the TeraStation.
- 4** Turn on the TeraStation while holding down the function button. This executes the recovery process.
- 5** The TeraStation shuts down automatically when the recovery process is complete.
- 6** Remove the card reader and press the power button. When the initial setup is complete, the TeraStation will reboot into Windows Storage Server.

After the recovery process is completed, the TeraStation is set to the state below when running under default settings.

- Drive 1

100 MB (EFI System partition)

100 GB (Basic Disk/Simple)

The remaining space is an unallocated area.

- Drives 2–4

The data on the drives cannot be viewed. They appear as “Foreign” in Disk Management. To view the area on the drives, right-click the area displayed as “Foreign” and then select *Import Foreign Disks*.

---

## Additional Information

---

### **Ethernet Port Number Is Not Correct on the Windows Storage Server**

Ethernet port numbers on the Windows Storage Server are assigned as the ports are recognized. They might be different from printed port numbers.

### **Buffalo Dashboard and Windows Disk Management Display Different Information**

Because different drive error algorithm rules are used between Buffalo Dashboard and Windows Disk Management, drive error may appear in different timing.

### **Preinstalled Software Does Not Work**

If a storage pool is enabled, preinstalled software does not work. Disable the storage pool.

# Chapter 9 Appendix

## LCD Panel

The LCD panel can be cycled through different modes by pressing the display button on the front of the TeraStation.

### Modes

LCD Message		Description	Corrective Action
Link Speed <b>Note:</b> The "x" is the number of the LAN port where the Ethernet cable is connected.	LANx Not Connected	Not connected to a network.	Connect an Ethernet cable to the LAN port.
	LANx Full Duplex 10 Mbps	Connected at 10 Mbps full duplex.	-
	LANx Full Duplex 100 Mbps	Connected at 100 Mbps full duplex.	-
	LANx 1000 Mbps	Connected at 1000 Mbps.	-
	LANx 2.5 Gbps	Connected at 2.5 Gbps.	-
	LANx 5 Gbps	Connected at 5 Gbps.	-
	LANx 10 Gbps	Connected at 10 Gbps.	-
Drive Space Used	Used Space C: 15% D: 0%	Displays the used space for drive C and D on the TeraStation.	-
Installed OS	Windows Storage Server 2016	Displays the OS installed on the TeraStation.	-
Hostname and LAN 1 IP Address	WS5410DN6xxx 192.168.11.150	Displays the hostname and the IP address of LAN 1 port. <b>Note:</b> This example is using a WS5420DN6 unit. The "x" in the hostname is the last three digits of the MAC address.	-
Date and Time	Date Time YYYY/MM/DD hh:mm	Displays the date and time set in the TeraStation.	-
The LAN 2 and LAN 3 IP Addresses	LANx 192.168.11.150	Displays the IP address of LAN 2 and LAN 3 ports.	-

### Errors and Status

If an error occurs, the error LED will glow red. After you change settings or format a drive, the info LED will glow amber. You can also confirm the current status from the LCD panel.

**Note:** The "x" in the LCD message is a number of drive or assigned drive letter where an error or information event occurs.



LCD Message	Description	Corrective Action
E11 Fan Failure	An error occurred in the fan speed.	Check that no foreign objects or dust are clogging the fan. If any foreign objects or dust are found, use a pair of tweezers, air duster, or other tools to remove them. If the error is displayed again, contact Buffalo technical support for assistance.
E12 Cooling Failure	A rise in the system temperature may have exceeded the allowable safety value.	Do not place objects in the area around the TeraStation. Also, move the TeraStation to a cool location.
E16 Drive x Not Found	Unable to find the drive.	The drive may be disconnected or may have failed. After shutting down, reinstall the drive.
E30 Replace Drive x	An error occurred, so the drive was removed from the volume.	Replace the drive.
I10 System Is Overheating	A rise in the system temperature may have exceeded the allowable safety value.	Move the TeraStation to a cool location. Do not place objects in the area around the TeraStation.
I12 Degraded Mode	Operating in degraded mode.	Check if the E30 message is also displayed on the LCD panel. In such a case, refer to the corrective action for the E30 message. If only this message is displayed, refer to the "I12 Message Appears Despite No Drive Errors" section in chapter 8.
I18 Rebuilding Drive x...	Rebuilding the volume. <b>Note:</b> Transfer speeds are slower during the rebuilding process.	Wait until resynchronization finishes. It will take about 23 hours for a RAID 5 volume and about 2–3 hours for a mirrored volume per a 4 TB TeraStation model. This message will disappear when resynchronization finishes.
I33 Replication Failure	An error occurred in replication.	From Buffalo Replication, click <i>Sync</i> to execute resynchronization. If the error is displayed again, contact Buffalo technical support for assistance.
I52 New Firmware Available	A new firmware version has been released.	Update the firmware.
I54 Backup Job x Failed	The backup job failed.	Make sure that the backup job is configured correctly. Make sure that the NAS is on and not in standby mode. If the backup job still fails, check the status of NAS, network, and backup source and destinations. Also, check the backup log to see if any errors were recorded.

## Default Settings

Administrator's Name	Administrator
Password	password
Shared Folders	Drives C and D are configured as administrative hidden shares by Windows Storage Server's default settings.
DHCP Client	Normally, the TeraStation will get its IP address automatically from a DHCP server on the network. If no DHCP server is available, then an IP address will be assigned as follows: IP Address: IP address will be assigned starting from "169.254". Subnet Mask: 255.255.0.0
Registered Groups	Windows Storage Server's default groups are registered.
Microsoft Network Group Setting	WORKGROUP

RAID Mode	Drive C: a mirrored volume that uses drives 1 and 2 Drive D: a RAID 5 volume that uses all drives* *For the WS5220DN6 series TeraStations, drive D is a mirrored volume that uses drives 1 and 2.
Local Security Policy	"Password must meet complexity requirements" is disabled by default.

The TeraStation has the following functions and roles:

**Features:**

.NET Framework 4.7, iSNS Server, Windows PowerShell 5.1, WoW64 Support etc.

**Roles:**

File and Storage Services

**Note:** For other installed roles and features, see "Roles and Features", which you can reach by clicking "Local Server" on the left side menu in "Server Manager".

---

## Specifications

---

Check the Buffalo website for information about the latest products and specifications.

Installed System	Workgroup Edition Model: Microsoft Windows Storage Server 2016 Workgroup Edition Standard Edition Model: Microsoft Windows Storage Server 2016 Standard Edition <b>Note:</b> The Microsoft Software License is on the d.buffalo website, <a href="http://d.buffalo.jp/WS5020N6/">http://d.buffalo.jp/WS5020N6/</a> . Be sure to read the terms and conditions of this license.	
LAN Interface	Standards Compliance	1GbE port: IEEE 802.3ab (1000BASE-T), IEEE 802.3u (100BASE-TX), IEEE 802.3 (10BASE-T) 10GbE port: IEEE 802.3an (10GBASE-T), IEEE 802.3bz (2.5GBASE-T, 5GBASE-T), IEEE 802.3ab (1000BASE-T), IEEE 802.3u (100BASE-TX)
	Data Transfer Rates	1GbE port: 10/100/1000 Mbps (auto sensing) 10GbE port: 2.5/5/10 Gbps, 100/1000 Mbps (auto sensing) <b>Note:</b> 1GbE ports only support full-duplex mode. Half-duplex mode is not available.
	Number of Ports	1 x 10GbE, 2 x 1GbE
	Connector Type	RJ-45 8-pin (auto MDI-X)
USB Interface	Standards Compliance	USB 3.0
	Data Transfer Rates	Max. 5 Gbps
	Number of Ports	WS5220DN6, WS5420DN6: 2 WS5420RN6: 3
	Connector Type	Type A
Other Interfaces	1 x D-sub 15 pin (female) port	

Internal Hard Drive	Number of Drive Bays	WS5220DN6: 2 WS5420DN6, WS5420RN6: 4
	Drive Interface	SATA 6 Gbps
	Supported Volume Types	WS5220DN6: mirrored, striped, spanned WS5420DN6, WS5420RN6: RAID 5, mirrored, striped, spanned
	Replacement Drive	Buffalo OP-HDN series drive <b>Note:</b> The new drive should be the same size as the replacement drive. The drives listed above are available from the Buffalo website.
Other	Power Supply	WS5220DN6, WS5420DN6: AC 100–240 V, 1.5 A, 50/60 Hz WS5420RN6: AC 100–240 V, 2.5–1.25 A, 50/60 Hz
	Dimensions (W x H x D, excluding protruding parts)	WS5220DN6: 170 x 170 x 230 mm; 6.7 x 6.7 x 9.1 in WS5420DN6: 170 x 215 x 230 mm; 6.7 x 8.5 x 9.1 in WS5420RN6: 430 x 44.3 x 430 mm; 16.9 x 1.7 x 16.9 in
	Weight	WS5220DN6: 5.0 kg; 11.0 lb WS5420DN6: 7.4 kg; 16.3 lb WS5420RN6: 8.9 kg; 19.6 lb
	Power Consumption	WS5220DN6, WS5420DN6: max. 85 W WS5420RN6: max. 100 W
	Operating Environment	Temperature: 0–40°C; 32–104°F Humidity: 10–85% non-condensing
	Compatible Devices	Windows PCs, tablets, and Mac computers with wired or wireless Ethernet connection. <b>Note:</b> The TeraStation requires an Ethernet connection with your computer for operation. The TeraStation cannot connect via USB.
	Supported OS	Windows 10, 8.1, 7 Windows Server 2016, 2012 R2, 2012, 2008 R2, 2008 macOS 10.13, 10.12, 10.11