

## USER'S MANUAL

### *SMART APP SINEWAVE UPS SERIES*

PR2200RTL2UA

PR3000RTL2UA



## INTRODUCTIONS

Thank you for purchasing the CyberPower Smart App Sinewave **PR2200RTXL2UA/ PR3000RTXL2UA** Uninterruptible Power Supply!

The product features 2430 Joules of surge protection, provides battery backup during power outages and is Active PFC compatible for safeguarding mission-critical servers, telecom equipment, VoIP and internetworking hardware that require seamless sine wave power. Its full Automatic Voltage Regulation (AVR) boost/buck technology delivers a consistent and clean AC power, protecting connected equipment and preventing costly business interruptions. This UPS is GreenPower UPS™ Bypass circuitry patented to save on energy costs by reducing energy consumption and heat buildup.

The UPS unit incorporates microprocessor-based full digital control and includes PowerPanel® Business Edition providing the user unsurpassed flexibility and control. An optional SNMP/HTTP Remote Management adapter (RMCARD205) supports remote management and control of the machine through a standard web browser.

### **AUTOMATIC VOLTAGE REGULATOR (AVR)**

The incoming utility power may be damaging to important data and hardware, but with Automatic Voltage Regulation, the computer will not experience damaging voltage levels. The AVR automatically increases low or decreases high voltage to a safe and consistent output voltage.

### **CyberPower GreenPower UPS™ Technology**

CyberPower's patented GreenPower UPS™ with Bypass Technology are ENERGY STAR complainant ensuring lower power consumption and energy costs compared to conventional UPS models. Even when utility power is normal, conventional UPS models constantly pass power through a transformer. By contrast, under normal conditions the advanced circuitry of a GreenPower UPS™ bypasses the transformer. As a result, the power efficiency is significantly increased while decreasing waste heat, using less energy, and reducing energy costs.

When an abnormal power condition occurs, the GreenPower UPS™ automatically runs power through its transformer to regulate voltage and provide "safe" power. Since utility power is normal over 88% of the time, the GreenPower UPS™ operates primarily in its efficient bypass mode.

The GreenPower UPS™ is also manufactured in accordance with the Restriction on Hazardous Substances (RoHS) directive making it one of the most environmentally-friendly on the market today.



## IMPORTANT SAFETY INSTRUCTIONS

This manual contains important instructions that should be followed during installation and maintenance of the UPS and batteries. Please read and follow all instructions carefully during installation and operation of the unit. Read this manual thoroughly before attempting to unpack, install, or operate.

**CAUTION!** The UPS must be connected to a grounded AC power outlet with fuse or circuit breaker protection. DO NOT plug the UPS into an outlet that is not grounded. If you need to de-energize this equipment, turn off and unplug the UPS.

**CAUTION!** The battery can energize hazardous live parts inside even when the AC input power is disconnected.

**CAUTION!** To prevent the risk of fire or electric shock, install in a temperature and humidity controlled indoor area, free of conductive contaminants. Please see specifications for acceptable temperature and humidity range.

**CAUTION!** For pluggable equipment, the socket-outlet shall be installed near the equipment and shall be easily accessible.

**CAUTION!** To reduce the risk of electric shock, do not remove the cover, except to service the battery. There are no serviceable parts inside, except for the battery.

**CAUTION!** To avoid electrical shock, turn off the unit and unplug it from the AC power source before servicing the battery or installing a computer component.

**CAUTION!** When installing the equipment, ensure that the sum of the leakage current of the UPS and the connected equipment does not exceed 3.5mA.

**CAUTION!** Do not unplug the unit from AC Power during operation, as this will invalidate the protective ground insulation.

**CAUTION!** To reduce the risk of fire, connect only to a circuit provided with 30 amperes maximum branch circuit overcurrent protection in accordance with the National Electric Code, ANSI/NFPA 70.

**CAUTION! DO NOT USE FOR MEDICAL OR LIFE SUPPORT EQUIPMENT!** CyberPower does not sell products for life support or medical applications. DO NOT use in any circumstance that would affect operation or safety of any life support equipment, with any medical applications, or patient care.

**CAUTION! DO NOT USE WITH OR NEAR AQUARIUMS!** To reduce the risk of fire, do not use with or near aquariums. Condensation from the aquarium can come in contact with metal electrical contacts and cause the machine to short out.

**CAUTION! DO NOT INSTALL THE UPS WHERE IT WOULD BE EXPOSED TO DIRECT SUNLIGHT OR NEAR A STRONG HEAT SOURCE!**

**CAUTION! DO NOT BLOCK OFF VENTILATION OPENINGS AROUND THE HOUSING!**

## IMPORTANT SAFETY INSTRUCTIONS (continued)

**CAUTION! DO NOT USE THE UPS ON ANY TRANSPORTATION!** To reduce the risk of fire or electric shock, do not use the unit on any transportation such as airplanes or ships. The effect of shock or vibration caused during transit and the damp environment can cause the unit to short out.

**CAUTION!** Dispose of or recycle the UPS after the end of its life, it should be in accordance with local regulations.

## UNPACKING

When you receive the unit, the package should contain the following items:

### 1. UPS Unit

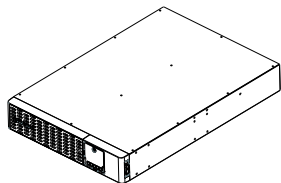

### 2. Faceplate

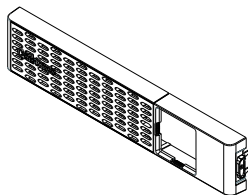

### 3. Rail Kit – CP2RAIL02

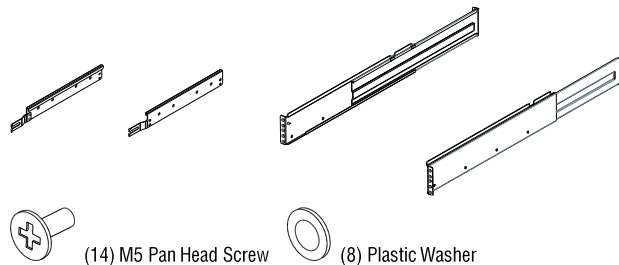

### 4. Management Cable

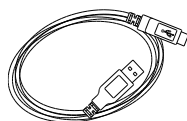

(1) USB Cable

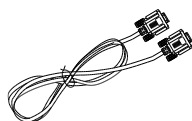

(1) Serial Cable

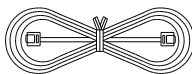

(1) EPO Cable (gray)

### 5. User's Manual

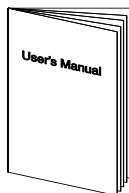

### 6. Mechanical Accessory

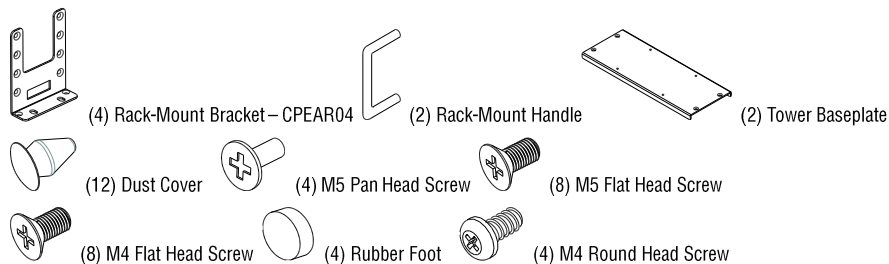

# PRODUCT OVERVIEW

## BASIC CONFIGURATION

### Front Panel

1. Power Switch
2. Toolless Battery Access Door
3. LCD Module
4. Front Panel Access Tabs
5. Faceplate

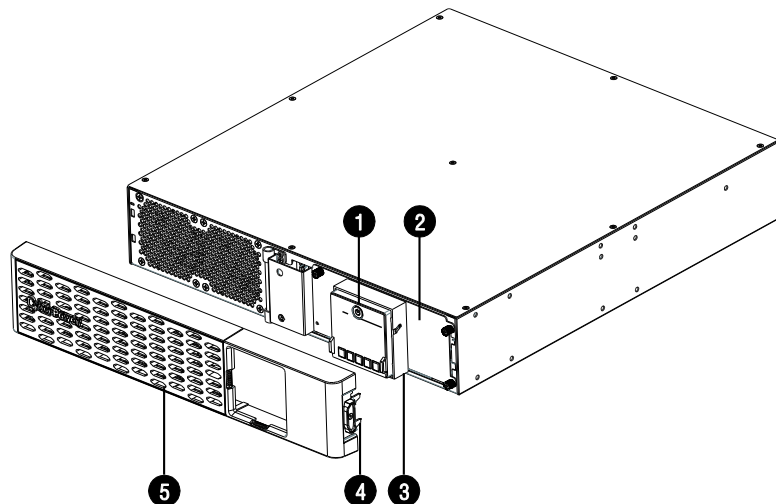

### Rear Panel

- |   |  |
|---|--|
| 1. Battery Backed and Surge Protected Outlet  | 8. Dry Contact                               |
| 2. Output Circuit Breaker                     | 9. Serial Port                               |
| 3. SNMP/HTTP Network Slot                     | 10. USB Port                                 |
| 4. Surge Protected Communication Ports (RJ45) | 11. EPO/ROO Port                             |
| 5. Input Circuit Breaker                      | 12. TVSS Screw                               |
| 6. AC Inlet                                   | 13. Wiring Fault Indicator                   |
| 7. BM/ENV Port                                | 14. Extended Battery Module Connector Socket |

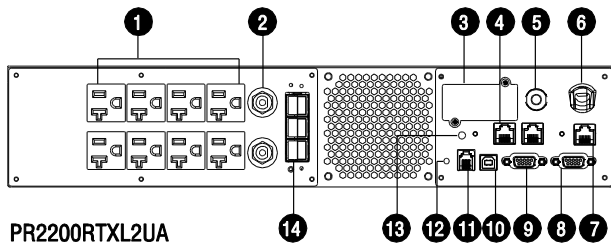

PR2200RTXL2UA

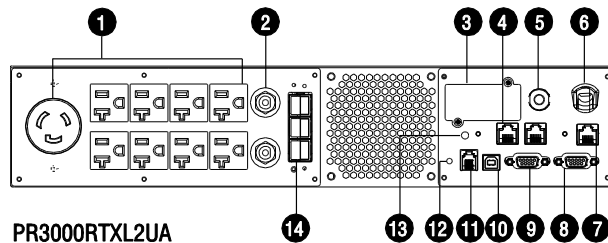

PR3000RTXL2UA

### **BM/ENV Port**

Connection port for built-in battery management module on extended battery module. The port also supports the CyberPower environment sensor.

## INSTALLATION

### Rack Installation for 2-post Rack

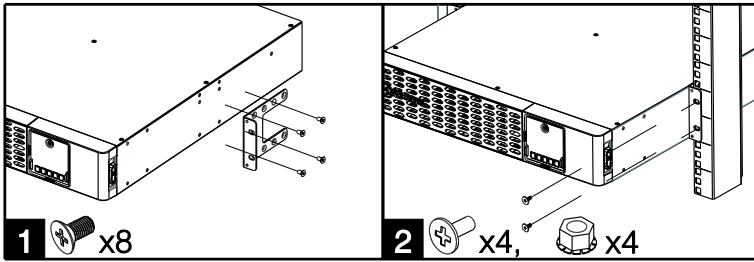

1. Attach the brackets with provided M5 flat head screws.
2. Affix the UPS to the rack with provided M5 pan head screws or suitable screws and cage nuts.

### Rack Installation for 4-post Rack

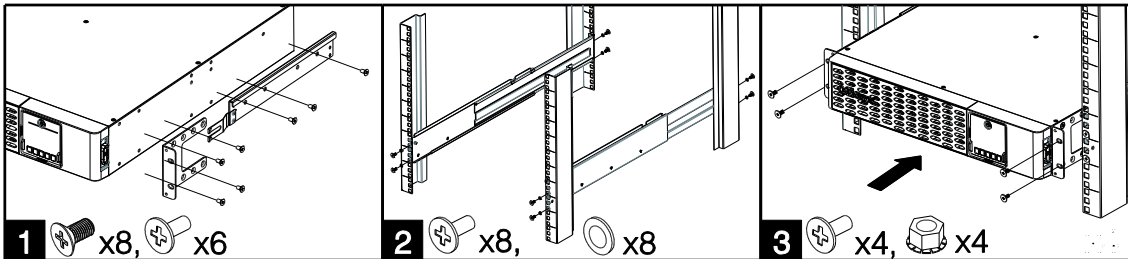

1. Use the provided M5 flat head screws to attach the brackets and provided M5 pan head screws for hanging brackets.
2. Screw the hanging rails to the rack with provided M5 pan head screws and plastic washers.
3. Lift the UPS upon the hanging rails and slide the unit into the rack. Affix the UPS to the rack with provided M5 pan head screws or suitable screws and cage nuts. If handles are needed, affix them to the brackets with M4 flat head screws.

### Tower Installation

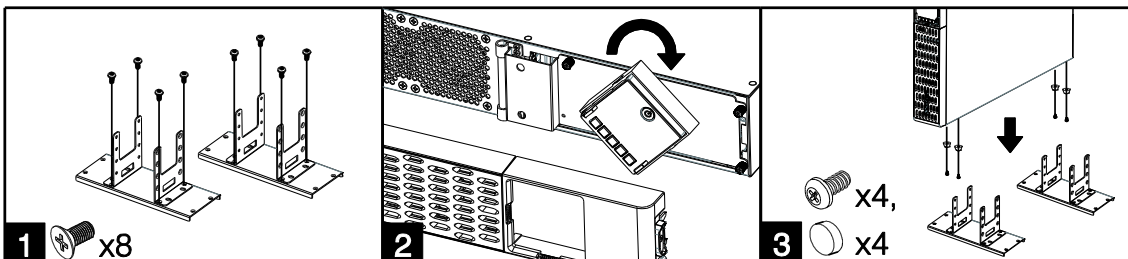

1. Attach the brackets to the baseplate with the provided M4 flat head screws.
2. Remove the faceplate and rotate the LCD module, then re-install the faceplate.
3. Screw the rubber feet with provided M4 round head screws and then put the UPS onto the assembled tower stand. You can also put the dust covers in the screw holes on the top side of the UPS to prevent dust from falling into the unit.

## BASIC OPERATION

### Normal Use

1. Connect equipment to the outlets on the rear panel of UPS.
2. Plug the UPS into a 2 pole, 3 wire grounded receptacle/ wall outlet.
3. Press the power switch on LCD module to turn on the UPS.

**Important! For first time usage, plug your UPS into an AC outlet to disable cold start protection. Otherwise your UPS will not turn on.**

## BASIC OPERATION (continued)

Be aware of the following statements:

- A. Your UPS may be used immediately upon receipt. However, **charging the battery for at least twelve (12) hours is recommended** to ensure the battery reaches its maximum charge. Charge loss may occur during shipping and storage. To recharge the battery, simply leave the unit plugged into an AC outlet. The unit will charge in either the on or off state.
- B. To maintain optimal battery charge, leave the UPS plugged into an AC outlet at all times.
- C. DO NOT plug a laser printer, copier, space heater, vacuum, paper shredder or other large electrical device to the UPS. The power demands of these devices will possibly overload and damage your UPS.
- D. Always plug the UPS into a 2 pole, 3 wire grounded receptacle/ wall outlet. Make sure the wall branch outlet is protected by a fuse or circuit breaker and does not service equipment with large electrical demands, e.g. air conditioner, refrigerator, copier, etc. Avoid using extension cords.
- E. To prevent the risk of electric shock, follow the steps to ground the UPS:
  - (a) Connect an earth wire to the TVSS screw on the rear panel of UPS.
  - (b) Connect another side of the earth wire to Earth.

### Storage

To store your UPS for an extended period, cover it and store with the battery fully charged. Recharge the battery every three months to ensure battery life.

### Operation/Storage Environment

To prevent risk of fire or electric shock, install or place the unit in a temperature and humidity controlled indoor area, free of conductive contaminants.

Operation	Temperature	32°F to 104°F (0°C to 40°C)
	Relative Humidity	0% - 95% Non-condensing
	Elevation	0 - 10000 feet (0 - 3000 meters)
Storage	Temperature	5°F to 113°F (-15°C to 45°C)
	Relative Humidity	0% - 95% Non-condensing
	Elevation	0 - 50000 feet (0 - 15000 meters)

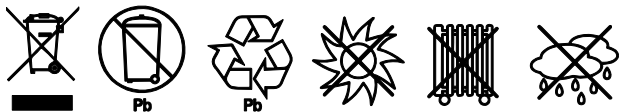

## DATA LINE PROTECTION

The surge protected communication ports (RJ45) are used to prevent power surges that travel through Ethernet lines from causing damage to electronics. Connect the Ethernet line from wall jack outlet to the surge protected communication port marked "IN" of the UPS. Then, connect another Ethernet line from surge protected communication port marked "OUT" of the UPS to the modem, computer, telephone, fax machine or network device.

## NETWORK OPERATION

Connect either the USB cable or Serial cable to the corresponding port on the UPS and on the computer with PowerPanel® Business Edition software installed. PowerPanel® Business Edition software is available on our website. Please go to [www.cyberpower.com](http://www.cyberpower.com) for the free download.

Note: USB and Serial port cannot be used simultaneously. Serial port will be disabled if the USB port is used.

Additionally, if you would like to control the UPS from a remote location, a CyberPower Remote Management Card (RMCARD) is required. For more information, visit [www.cyberpower.com](http://www.cyberpower.com).

# PRODUCT ADVANCED SETTING

## LCD OPERATION GUIDE

### Display Interface

1. Power Switch/Power on Indicator
2. Online Indicator
3. Fault/Warning Indicator
4. On Battery Indicator
5. Night Mode Indicator
6. Display Screen
7. Menu Button
8. Esc Button
9. Up Button
10. Down Button
11. Enter Button

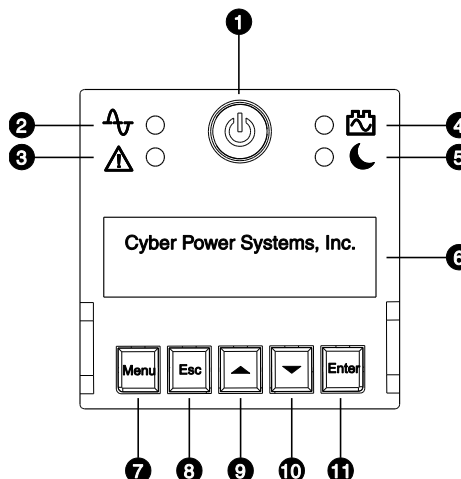

### Basic Operation

Press Up and Down Button to scroll through the UPS status. Press Esc button to go back to top.

Menu	Items
Status	<ul style="list-style-type: none"> <li>• Operation Mode</li> <li>• Input Voltage Information</li> <li>• Output Voltage Information</li> <li>• Estimated Runtime</li> <li>• Battery Information</li> <li>• Load Information</li> <li>• NCL Status</li> <li>• UPS Temperature</li> <li>• Date &amp; Time</li> </ul>

### LCD Setting Guide

Press Menu Button to enter Setup Menu and use Up/Down Button to scroll through menus. Press Enter Button to go into the selected menu and use the Up/Down Button and Enter Button to select the setting item and to complete the setting. Esc Button is pressed to exit the submenu and go back to previous page.

Menu	Items
Basic Setup	<ul style="list-style-type: none"> <li>• Utility Quality</li> <li>• Sensitivity</li> <li>• Audible Alarm</li> <li>• Extended Battery Module Quantity*</li> </ul>
Night Mode	<ul style="list-style-type: none"> <li>• Night Mode Switch</li> <li>• Night Mode Audible Alarm</li> <li>• Night Mode LCD Switch</li> <li>• Night Mode LED Switch</li> <li>• Night Mode Max Fan Speed</li> </ul>
Outlet Control	<ul style="list-style-type: none"> <li>• UPS Configuration</li> <li>• NCL Configuration</li> </ul>
Test	<ul style="list-style-type: none"> <li>• Self Test</li> <li>• Alarm Test</li> <li>• Battery Calibration</li> </ul>
Logs	<ul style="list-style-type: none"> <li>• Event 1-10</li> </ul>
About	<ul style="list-style-type: none"> <li>• UPS Model Name</li> <li>• UPS Serial Number</li> <li>• Last Battery Change Date</li> <li>• Next Battery Change Date</li> <li>• UPS Firmware Version</li> <li>• LCD Firmware Version</li> <li>• IP Address</li> <li>• MAC ID</li> <li>• Service Port Number</li> <li>• BM Status</li> <li>• UPS Battery Information</li> </ul>
Advanced Setup	<ul style="list-style-type: none"> <li>• Output Voltage</li> <li>• Minimum Output Voltage</li> <li>• Maximum Output Voltage</li> <li>• LCD Hibernation</li> <li>• Cycling Display</li> <li>• Low Battery Threshold</li> <li>• Battery Change Date</li> <li>• Schedule Test</li> <li>• Date and Time</li> <li>• Power Meter Rest</li> <li>• IP Access</li> <li>• IP Address</li> <li>• Subnet Mask</li> <li>• Gateway</li> <li>• Firmware Update**</li> <li>• Back to Default</li> </ul>

\*Select models

\*\*Only displayed in standby mode

## LCD OPERATION GUIDE (continued)

### Menu/Basic Setup

In order to better supply power to the connected equipment, it is recommended to check settings in this menu before you start using your UPS.

Item	Default	Option	Description
Utility Quality	Normal	<ul style="list-style-type: none"> <li>• Good</li> <li>• Normal</li> <li>• Poor</li> </ul>	<p>Select the voltage quality of the input utility power. If Good is selected, the UPS will go to battery mode more often to supply the cleanest power to connected devices. If Poor is selected, the UPS will tolerate more power fluctuations and go to battery mode less often.</p>
		<ul style="list-style-type: none"> <li>• (Customized)</li> </ul>	<p>“Customized” shows up when Maximum/Minimum Output Voltage has been adjusted in Advanced Setup Menu or through software.</p>
Sensitivity	Medium	<ul style="list-style-type: none"> <li>• High</li> <li>• Medium</li> <li>• Low</li> </ul>	<p>Select the sensitivity level to power events for connected equipment. If the connected equipment is highly sensitive to power events, select High; the UPS will go to battery mode more often to provide the cleanest power. If the connected equipment can tolerate more power events, select Low; the UPS will go to battery mode less often.</p>
Audible Alarm	Normal	<ul style="list-style-type: none"> <li>• Normal</li> <li>• Mute on Battery</li> </ul>	<p>If Mute On Battery is selected, the UPS will not emit an alarm indicating the UPS is providing power from battery.</p>
Extended Battery Module Quantity*	0	<ul style="list-style-type: none"> <li>• 0-10</li> <li>• Auto-sensing</li> </ul>	<p>If Auto-sensing is selected, the UPS will change the numbers automatically.</p>

\*Select models

### Menu/Night Mode

Night Mode is an independent mode for users to quickly turn on/off alarms, LED, LCD and fan noise for specific usage and times. All setting items in Night Mode only perform when Night Mode Switch is set On and at the same time the Night Mode Indicator on the LCD module will illuminate.

Item	Default	Option	Description
Night Mode Switch	Off	<ul style="list-style-type: none"> <li>• On</li> <li>• Off</li> </ul>	<p>It is the main switch for Night Mode. All settings items will only apply when On is selected and Night Mode is active.</p>
Night Mode Audible Alarm	Mute on Battery	<ul style="list-style-type: none"> <li>• Normal</li> <li>• Mute on Battery</li> <li>• Completely Mute</li> </ul>	<p>If Mute On Battery is selected, the UPS will not emit reminding alarm indicating the UPS is providing power from battery. All alarms are disabled if Completely Mute is selected.</p>
Night Mode LCD Switch	Off	<ul style="list-style-type: none"> <li>• On</li> <li>• Off</li> </ul>	<p>If On is selected, the UPS will follow LCD Hibernation setting in Advanced Setup Menu. If Off is selected, the LCD screen will turn off after a few seconds of inactivity. Pressing any button will activate the LCD screen.</p>
Night Mode LED Switch	Off	<ul style="list-style-type: none"> <li>• On</li> <li>• Off</li> </ul>	<p>If On is selected, the LED indicators work normally. If Off is selected, the LED indicators will turn off after a few seconds except for Fault Indicator. Pressing any button will activate the LED Indicators.</p>
Night Mode Maximum Fan Speed	Full	<ul style="list-style-type: none"> <li>• Full</li> <li>• High</li> <li>• Medium</li> <li>• Low</li> </ul>	<p>Options are shown in bar chart. Select the maximum fan noise level you can accept in Line mode. This setting is also related to runtime in battery mode. UPS performs best backup time when Full is selected. Runtime decreases as maximum fan speed gets lower than Full.</p>



## LCD OPERATION GUIDE (continued)

### Menu/Outlet Control

Use this menu to configure UPS outlet performance. Outlets are divided into Critical and Non-Critical (NCL) outlets. Connect the mission critical devices into Critical outlets and nonessential equipment into NCL outlets. If equipment needs to be shut down or reboot in a specific order, plug the equipment into separate outlet groups.

Item	Default	Option	Description
NCL Switch	On	<ul style="list-style-type: none"> <li>• On</li> <li>• Delay On</li> <li>• Off</li> <li>• Delay Off</li> <li>• Reboot</li> <li>• Delay Reboot</li> </ul>	This is the main switch for NCL outlet groups. Note: Can only be configured in the Submenu, NCL Configuration.
Delay Turn On	4 seconds	<ul style="list-style-type: none"> <li>• 0-600 seconds</li> </ul>	The amount of time that the outlets will wait before actual startup.
Delay Turn Off	4 seconds	<ul style="list-style-type: none"> <li>• 0-600 seconds</li> </ul>	The amount of time that the outlets will wait before actual shutdown.
Reboot Duration	4 seconds	<ul style="list-style-type: none"> <li>• 4-300 seconds</li> </ul>	The amount of time that the outlets will remain off before the UPS restart itself.
Minimum Restored Capacity	0%	<ul style="list-style-type: none"> <li>• 0-100%</li> </ul>	It is the criteria for UPS to perform auto-restart as utility is restored. If battery capacity is higher than this setting, the auto-restart will be performed; otherwise, the UPS will keep charging the battery until battery capacity reaches that level.
Uptime on Battery	Disable	<ul style="list-style-type: none"> <li>• Enable: 5-1800 seconds</li> <li>• Disable</li> </ul>	Set the maximum runtime on battery mode. The UPS will shut down after the amount of time spent in battery mode has reached this setting. Make sure the estimated runtime is larger than this setting; otherwise, the UPS will still stop supplying power when it is running out of battery.
Reserved Runtime	Disable	<ul style="list-style-type: none"> <li>• Enable: 0-1800 seconds</li> <li>• Disable</li> </ul>	When the UPS is in battery mode, it will cut off output power when the remaining runtime reaches the level.
Off on Overload	Disable	<ul style="list-style-type: none"> <li>• Enable</li> <li>• Disable</li> </ul>	NCL outlets will be turned off if the UPS is overload in battery mode if the item is enabled. NCL outlets will turn on automatically as utility is restored. Note: Can only be configured in the Submenu, NCL Configuration.

### Menu/Test

This menu provides basic tests and calibration for users to check the current performance of the UPS.

Item	Default	Option	Description
Self Test	No	<ul style="list-style-type: none"> <li>• Yes</li> <li>• No</li> </ul>	Select Yes to order the UPS to quickly test the backup function by entering to battery mode, checking if it works. The test takes around 10 seconds.
Alarm Test	Short Test	<ul style="list-style-type: none"> <li>• Short Test</li> <li>• Continuous Test</li> </ul>	This item tests the alarm's audible warning and LED indicators' functionalities. Short test lasts 5 seconds. In continuous testing, press any button to stop the test.
Battery Calibration	No	<ul style="list-style-type: none"> <li>• Yes</li> <li>• No</li> </ul>	<p>If Yes is selected, the UPS will start discharging the battery and record the runtime to calibrate the information on estimated runtime. Before calibrate your runtime, please make sure the following conditions are not currently happening, or the calibration will fail:</p> <ul style="list-style-type: none"> <li>A. Load &lt; 20%</li> <li>B. Load variations</li> <li>C. Low battery</li> <li>D. Power failure</li> <li>E. Charge &lt; 8 hours</li> </ul>

## LCD OPERATION GUIDE (continued)

### Menu/Logs

All kinds of events are recorded and the UPS will show the last 10 events in this menu. Events are categorized into four sorts and shown in a capital letter in a single event log on the LCD screen: (F) Fault, (W) Warning, (S) Shutdown, and no letter for a normal transfer event.

### Menu/Advanced Setup

This menu contains more adjustable and detailed items for UPS advanced usage. Read the item descriptions below thoroughly before you change the settings.

Item	Default	Option	Description
Output Voltage	120V*	<ul style="list-style-type: none"> <li>• 100V</li> <li>• 110V</li> <li>• 120V</li> <li>• 127V</li> </ul>	Select the AC output voltage on battery mode.
Minimum Output Voltage	<ul style="list-style-type: none"> <li>100V: 89V</li> <li>110V: 96V</li> <li>120V: 105V</li> <li>127V: 111V</li> </ul>	<ul style="list-style-type: none"> <li>• 100V: 86-92V</li> <li>• 110V: 93-99V</li> <li>• 120V: 102-108V</li> <li>• 127V: 108-114V</li> </ul>	<p>Set the value lower if the utility voltage is usually low to avoid unnecessary battery usage, and vice versa.</p> <p>Make sure the connected equipment can work under the voltage condition.</p>
Maximum Output Voltage	<ul style="list-style-type: none"> <li>100V: 111V</li> <li>110V: 124V</li> <li>120V: 135V</li> <li>127V: 143V</li> </ul>	<ul style="list-style-type: none"> <li>• 100V: 108-114V</li> <li>• 110V: 121-127V</li> <li>• 120V: 132-138V</li> <li>• 127V: 140-146V</li> </ul>	<p>Set the value lower if the utility voltage is usually low to avoid unnecessary battery usage, and vice versa.</p> <p>Make sure the connected equipment can work under the voltage condition.</p>
LCD Hibernation	After 1 minute	<ul style="list-style-type: none"> <li>• Never</li> <li>• After 1 minute</li> <li>• After 5 minutes</li> <li>• After 10 minutes</li> </ul>	After this amount of time with no activity, the LCD screen will shut off to save energy.
Cycling Display	Never	<ul style="list-style-type: none"> <li>• Never</li> <li>• After 10 seconds</li> <li>• After 20 seconds</li> <li>• After 30 seconds</li> </ul>	After this amount of time with no activity, UPS will start cycling the status information on LCD screen.
Low Battery Threshold	300 seconds	<ul style="list-style-type: none"> <li>• 0-1800 seconds</li> </ul>	The UPS will emit an audible alarm, as a reminder that remaining runtime is reaching the threshold.
Battery Change Date	---/---	<ul style="list-style-type: none"> <li>• Month/Year</li> </ul>	Optional setup information for users to record the installation date of battery pack. Reset the data when replacing new battery pack.
Schedule Test – On Startup	Yes	<ul style="list-style-type: none"> <li>• Yes</li> <li>• No</li> </ul>	If Yes is selected, the UPS will perform Self Test every time on startup.
Schedule Test – Frequency	Never	<ul style="list-style-type: none"> <li>• Never</li> <li>• Every 1 week</li> <li>• Every 2 weeks</li> <li>• Every 3 weeks</li> <li>• Every 4 weeks</li> </ul>	Select the amount of time that the UPS will perform Self Test periodically after startup.
Date and Time	---/--/-- --:--	<ul style="list-style-type: none"> <li>• Year/Month/Day Hour:Minute</li> </ul>	Set the Date and Time for use in data/event logs.
Power Meter Reset	No	<ul style="list-style-type: none"> <li>• Yes</li> <li>• No</li> </ul>	Select Yes to reset the value of Load Energy in Status menu.
IP Access	DHCP	<ul style="list-style-type: none"> <li>• DHCP</li> <li>• Manual IP Setup</li> </ul>	Select the way to access the IP/Subnet Mask/Gateway. This shows “No Web Device” when no RMCARD is installed.
IP Address	Auto-sensing	<ul style="list-style-type: none"> <li>• Auto-sensing</li> <li>• Manual Key-in</li> </ul>	Change the IP Access setting to manual IP Setup and then this item can be adjusted manually. This shows “No Web Device” when no RMCARD is installed.
Subnet Mask	Auto-sensing	<ul style="list-style-type: none"> <li>• Auto-sensing</li> <li>• Manual Key-in</li> </ul>	Change the IP Access setting to manual IP Setup and then this item can be adjusted manually. This shows “No Web Device” when no RMCARD is installed.
Gateway	Auto-sensing	<ul style="list-style-type: none"> <li>• Auto-sensing</li> <li>• Manual Key-in</li> </ul>	Change the IP Access setting to manual IP Setup and then this item can be adjusted manually. This shows “No Web Device” when no RMCARD is installed.
Firmware Update**	No	<ul style="list-style-type: none"> <li>• Yes</li> <li>• No</li> </ul>	Select Yes to update the firmware of UPS in standby mode.
Back to Default	No	<ul style="list-style-type: none"> <li>• Yes</li> <li>• No</li> </ul>	Select Yes to restore the UPS factory default settings.

\*Select models and regions

\*\*Only displayed in standby mode

## EPO AND ROO CONFIGURATION

The Emergency Power Off (EPO) port is a safety feature that can be used to immediately shut down the UPS and cut off its power supply to connected equipment. It is necessary to manually press the power switch on the LCD module to restart the UPS and reapply power to connected equipment.

The Remote On/Off (ROO) shares the same port with EPO and those two functions can be used at the same time. ROO is a remote power control function, which allows users not only to power on but also power off the UPS in a remote location.

### Installation

1. Verify the UPS is off and unplugged.
2. The EPO/ROO interface is an IEC 60950 safety extra low voltage (SELV) circuit. This circuit must be separated from hazardous voltage circuits by reinforced insulation. Follow the appropriate circuit diagram below to wire the provided gray EPO cable to your EPO/ROO configuration. Use ONLY latching switch for your ROO configuration.

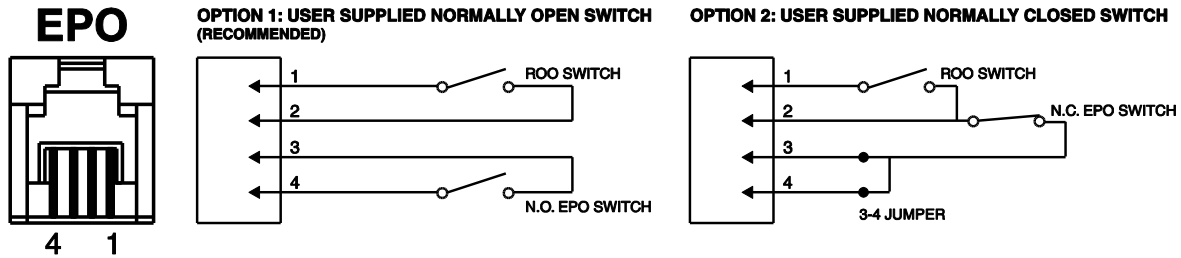

3. After wiring, make sure the external EPO/ROO switch is not activated to enable UPS output.
4. Plug the UPS into an AC outlet and turn the UPS on via power switch on the LCD module.
5. Activate the external EPO/ROO switch to test the function. Check the status change of UPS from its LCD module.
6. For EPO user: De-activate the external EPO switch and restart the UPS via power switch on the LCD model.  
For ROO user: Press the external ROO switch again to restart the UPS.

### Restriction on ROO

- A. ROO can only turn on the UPS when utility is available.
- B. ROO becomes inactive if the UPS is shut down due to Fault, Low Battery or EPO; it is necessary to manually press the power switch on the LCD module to restart the UPS and reapply power to connected equipment.
- C. ROO is active only when UPS power status is the same as ROO circuit.\* If they are different, manually adjust the external ROO switch to synchronize current UPS status.

For instance, the UPS is turned off via power switch on the LCD module; however, the ROO switch stays in “on” position, which means the contact is closed. Users have to manually press the external ROO switch to “off” position, making contact open, to reactivate the ROO, verifying the power status shown on LCD module and ROO switch is on the same page. And then users can press the external ROO switch again to turn on the UPS.

\*Note: Power switch on the LCD module, software and external ROO switch can all turn on/off the UPS.

## DRY CONTACT

This UPS offers users the solution for UPS status monitoring via two output relays. Refer to Network Operation in this manual, verifying the UPS is connected to a computer with PowerPanel® Business Edition installed or is equipped with RMCARD. Follow the circuit provided by PPBE software or RMCARD browser to wire your dry contact port and choose your preferred monitoring status via those interfaces.

UPS status which can be monitored by dry contact is listed below:

UPS Status	UPS Conditions
Power Failure*	UPS detects utility failure.
Battery Low*	Battery capacity is lower than threshold.
Summary Alarm	UPS exits alarms due to Inverter Fault, Output Short, Over Temperature, Overload, Battery Overcharge, Low Battery, and Wiring Fault.
UPS Fail	UPS has malfunctioned due to Inverter Fault, DC Power Fault, and Over Temperature.

\*Default settings of relay contacts are Power Failure and Battery Low (Normally Open).

## BATTERY REPLACEMENT

Read and follow the important safety instructions before servicing the batteries. Replacement of batteries located in an operator access area. Visit CyberPower official website [www.cyberpower.com](http://www.cyberpower.com) or contact your dealer for more information on battery replacement.

**CAUTION!** RISK OF EXPLOSION IF BATTERY IS REPLACED BY AN INCORRECT TYPE. When replacing batteries, replace with the same number of the following battery: CyberPower RB1260X8 for PR2200RTXL2UA/ PR3000RTXL2UA.

**CAUTION!** Risk of Energy Hazard, 12V, maximum 9AH battery.

**CAUTION!** The used batteries are considered hazardous waste and must be disposed through recycling. Most retailers that sell lead-acid batteries collect used batteries for recycling, as required by local regulations. Do not dispose of batteries in a fire. The batteries may explode.

**CAUTION!** Do not open or mutilate batteries. Released material is harmful to the skin and eyes. It may be toxic.

**Take the following precautions before replacing the battery:**

1. Remove watches, rings, or other metal objects.
2. Use tools with insulated handles.
3. Wear rubber gloves and boots.
4. Do not lay tools or metal parts on top of batteries.
5. Determine if battery is inadvertently grounded. If inadvertently grounded, remove source from ground. **CONTACT WITH ANY PART OF A GROUNDED BATTERY CAN RESULT IN ELECTRICAL SHOCK.** The likelihood of such shock can be reduced if such grounds are removed during installation and maintenance (applicable to equipment and remote battery supplies not having a grounded supply circuit).

## BATTERY REPLACEMENT PROCEDURE

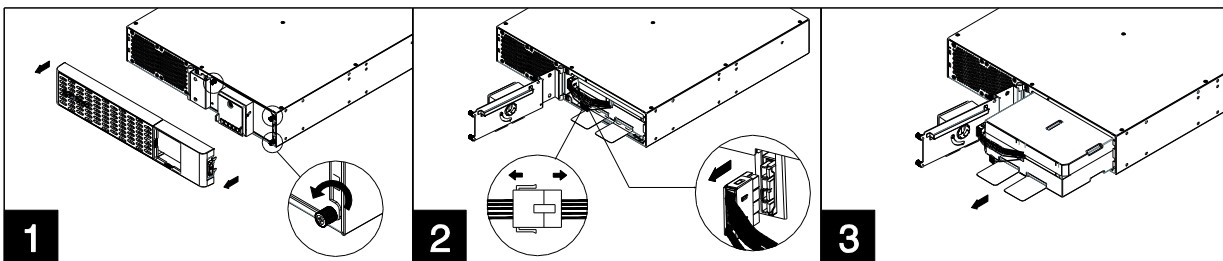

1. Remove faceplate and unscrew the thumbscrews on battery cover and then open the battery cover. Note: Thumbscrews are designed fixed on the battery cover, do not remove them from the metal cover.
2. Disconnect the battery and battery management module connector.
3. Insert the new battery pack. Assemble the connectors, thumbscrews and faceplate. Recharge the unit for at least 12 hours to ensure the UPS performs expected runtime.

**Reminder:** Battery Change Date is optional setup information for users to record the installation date of battery pack. It can be adjusted through LCD module in Advanced Setup Menu or through software.

## TECHNICAL SPECIFICATIONS

Model	PR2200RTL2UA	PR3000RTL2UA
<b>General</b>		
UPS Topology	Line-interactive	
Energy Saving	GreenPower UPS™ Bypass Technology	
<b>Input</b>		
Nominal Input Voltage	100/110/120V	
Input Voltage Range	For 110/120V systems: 78V – 149V; For 100V systems: 75V – 119V	
Input Voltage Adjustable Range	For 110/120V systems: 75V – 155V; For 100V systems: 70V – 129V	
Input Frequency	50/60Hz +/- 3Hz (Auto-sensing)	
Plug Type	NEMA L5-30P	
Power Cord Length	10ft	
<b>Output</b>		
Power Capacity	2200VA/2200W	3000VA/3000W*
On Battery Output Voltage	100/110/120V +/- 5%	
On Battery Output Frequency	50/60Hz +/- 1%	
On Battery Output Waveform	Sine Wave	
Outlet	(8) NEMA 5-15/20R	(8) NEMA 5-15/20R, (1) NEMA L5-30R
Overload Protection	On Utility: Circuit breaker; On Battery: Internal current limiting	
Transfer Time	4ms typical; 10ms maximum	
<b>Battery</b>		
Battery Type	Sealed Maintenance Free Lead Acid Battery	
Replacement Battery Pack	RB1260X8	
RBP Quantity	1	
Typical Recharge Time	3 hours to 90% from total discharge under 100% load	
Extended Battery Module	BP48VP2U03	
<b>Surge Protection and Filtering</b>		
Surge Suppression	2430 Joules	
EMI/RFI Filtering	Yes	
Data Line Protection	1-in, 1-out (RJ45)	
<b>Management and Communications</b>		
LCD/LED Indicator	Matrix LCD Panel; Power on, Online, On Battery, Fault/Warning, Night mode and Wiring fault LED indicators	
Audible Alarm	Battery mode, Low battery, Overload, Overcharge, Overheat	
Interface	(1) USB, (1) Serial, (1) Dry contact, (1) Expansion slot	
EPO/ROO Port	Yes	
Software	PowerPanel® Business Edition	
SNMP/HTTP Remote Monitoring	Yes, with optional RMCARD	
<b>Physical</b>		
Dimensions	2U Rack, 17.05" x 34.1" x 24.8" / 433 x 86.5 x 630 (mm)	
Weight	93lbs / 42.2kg	88.4lbs / 40.1kg
<b>Conformance</b>		
Approvals	UL1778, cUL107.1, FCC Part15 Class A, VCCI Class A, ENERGY STAR	
Environmental	RoHS Compliant	

\* Refer below de-rating information for 100/110V systems:  
 PR3000RTL2UA: 2400VA/2400W@100V, 2700VA/2700W@110V.

## TROUBLESHOOTING

Problem	Possible Cause	Solution
UPS does not provide power to equipment.	Circuit breaker has tripped due to an overload.	Turn the UPS off and unplug at least one piece of equipment. Wait 10 seconds, reset the circuit breaker and then turn the UPS on.
	Batteries are discharged.	Recharge the UPS for at least 3 hours.
	UPS has been damaged by a surge or spike.	Contact CyberPower for repair.
UPS does not perform expected runtime.	Non-critical outlets have turned off automatically due to an overload in battery mode.	NCL outlets will be turned on automatically as utility is restored. To avoid recurring, check "Off on Overload" setting in Outlet Control Menu and disable the function.
	Batteries are not fully charged.	Recharge the batteries by leaving the UPS plugged in.
UPS cannot be turned on.	Batteries are degraded.	Contact CyberPower about replacement batteries.
	UPS is not connected to an AC outlet.	The unit must be connected to a 100 – 125V outlet.
	Batteries are worn out.	Contact CyberPower about replacement batteries.
PowerPanel® Business Edition is inactive.	Mechanical problem.	Contact CyberPower for repair.
	The serial cable or USB cable is not connected.	Connect the cable to your UPS and computer. Use the cable that came with the unit.
	The serial cable or USB cable is connected to the wrong or defected port.	Try another port on the computer.
Night mode fan speed control is inactive. Fans keep rotating in a higher speed level in line mode.	UPS is not providing battery power.	Shutdown the computer and tune the UPS off. Wait 10 seconds and turn the UPS back on to reset the unit.
	Ambient temperature is too high.	Turn off the unit and check the ventilation.
	Overload for the fan speed level.	Adjust the fan speed to a higher level, or turn the UPS off and unplug at least one piece of equipment. Wait 10 seconds and then turn the UPS on.
"Service Battery" message appears on LCD screen.	Component fault, such as fans.	Call CyberPower for repair.
	The Battery Replacement Date has reached the recommended maintenance period.	Perform a runtime calibration to verify battery capacity is sufficient and acceptable. If batteries have been recently replaced, then reset the Battery Replacement Date using PowerPanel® Business Edition-Agent software or RMCARD interface; you can also reset the Battery Change Date in Advanced Setup Menu through LCD module.

Additional troubleshooting information can be found at [www.cyberpower.com](http://www.cyberpower.com).

## REGULATORY COMPLIANCE

**FCC Compliance Statement** This device complies with part 15 of the FCC rules. Operation is subject to the following two conditions: (1) this device may not cause harmful interference, and (2) this device must accept any interference received, including interference that may cause undesired operation.

*Note:* This equipment has been tested and found to comply with the limits for a Class A digital device, pursuant to part 15 of the FCC Rules. These limits are designed to provide reasonable protection against harmful interference when the equipment is operated in a commercial environment. This equipment generates, uses, and can radiate radio frequency energy and, if not installed and used in accordance with the instruction manual, may cause harmful interference to radio communications. Operation of this equipment in a residential area is likely to cause harmful interference in which case the user will be required to correct the interference at his own expense.

*Important:* Changes or modifications not expressly approved by the party responsible for compliance could void the user's authority to operate the equipment.

**Canadian Compliance Statement** CAN ICES-3 (A)/NMB-3(A)

**VCCI Compliance Statement** この装置は、クラス A 情報技術装置です。この装置を家庭環境で使用すると電波妨害を引き起こすことがあります。この場合には使用者が適切な対策を講ずるよう要求されることがあります。VCCI-A



## LIMITED WARRANTY AND CONNECTED EQUIPMENT GUARANTEE

Read the following terms and conditions carefully before using the CyberPower **PR2200RTXL2UA/ PR3000RTXL2UA** (the "Product"). By using the Product you consent to be bound by and become a party to the terms and conditions of this Limited Warranty and Connected Equipment Guarantee (together referred to as this "Warranty"). If you do not agree to the terms and conditions of this Warranty, you should return the Product for a full refund prior to using it.

### Who is providing this warranty?

CyberPower Systems (USA), Inc. ("CyberPower") provides this Limited Warranty.

### What does this warranty cover?

This warranty covers defects in materials and workmanship in the Product under normal use and conditions. It also covers equipment that was connected to the Product and damaged because of the failure of the Product.

### What is the period of coverage?

This warranty covers the Product for three years and connected equipment for as long as you own the Product.

### Who is covered?

This warranty only covers the original purchaser. Coverage ends if you sell or otherwise transfer the Product.

### How do you get warranty service?

1. Before contacting CyberPower, identify your Product model number, the Purchase Date, and each item of Connected Equipment (E.G. Computer tower, Computer Monitor, Cable Modem, etc).
2. Visit our web site at <https://www.cyberpowersystems.com/support> or Call us at (877) 297-6937.
3. If your product requires warranty service you must provide a copy of your dated purchase receipt or invoice.

### How do you open a connected equipment claim?

1. Call us at (877) 297-6937 or write to us at Cyber Power Systems (USA), Inc., 4241 12th Ave. E., STE 400, Shakopee, MN 55379, or send us an e-mail message at [claims@cpsww.com](mailto:claims@cpsww.com) for instructions, within 10 days of the occurrence.
2. When you contact CyberPower, identify the Product, the Purchase Date, and the item(s) of Connected Equipment. Have information on all applicable insurance or other resources of recovery/payment that are available to the Initial Customer and Request a Claim Number.
3. You must provide a dated purchase receipt (or other proof of the original purchase) for the CyberPower unit and connected equipment. You also need to provide a description of the damage to your connected equipment.
4. Pack and ship the product to CyberPower and, if requested, the item(s) of Connected Equipment, a repair cost estimate for the damage to the Connected Equipment, and all claim forms that CyberPower provides to you. Show the Claim Number on the shipping label or include it with the product. You must prepay all shipping costs, you are responsible for packaging and shipment, and you must pay the cost of the repair estimate.

### How long do I have to make a claim?

All claims must be made within ten days of the occurrence.

### What will we do to correct problems?

CyberPower will inspect and examine the Product.

If the Product is defective in material or workmanship, CyberPower will repair or replace it at CyberPower's expense, or, if CyberPower is unable to or decides not to repair or replace the Product (if defective) within a reasonable time, CyberPower will refund to you the full purchase price you paid for the Product (purchase receipt showing price paid is required). If it appears that our Product failed to protect any equipment plugged into it, we will also send you forms for making your claim for the connected equipment. We will repair or replace the equipment that was damaged because of the failure of our Product or pay you the fair market value (NOT REPLACEMENT COST) of the equipment at the time of the damage. We will use Orion Blue Book, or another third-party valuation guide, or eBay, craigslist, or other source to establish that amount. Our maximum liability is limited to \$400,000 for the PR2200RTXL2UA and PR3000RTXL2UA.

### Who pays for shipping?

We pay when we send items to you; you pay when you send items to us.

### What isn't covered by the warranty?

1. This Warranty does not cover any software that was damaged or needs to be replaced due to the failure of the Product or any data that is lost as a result of the failure or the restoration of data or records, or the reinstallation of software.
2. This Warranty does not cover or apply to: misuse, modification, operation or storage outside environmental limits of the Product or the equipment connected to it, nor for damage while in transit or in storage, nor if there has been improper operation or maintenance, or use with items not designed or intended for use with the Product, such as laser printers, appliances, aquariums, medical or life support devices, etc.

### What are the limitations?

The sole and exclusive remedies of the Initial Customer are those provided by this Warranty.

1. This Warranty does not apply unless the Product and the equipment that was connected to it were connected to properly wired and grounded outlets (including compliance with electrical and safety codes of the most current electrical code), without the use of any adapters or other connectors.
2. The Product must have been plugged directly into the power source and the equipment connected to the Product must be directly connected to the Product and not "daisy-chained" together in serial fashion with any extension cords, another Product or device similar to the Product, surge suppressor, or power tap. Any such installation voids the Limited Warranty.
3. The Product and equipment connected to it must have been used properly in a suitable and proper environment and in conformance with any license, instruction manual, or warnings provided with the Product and the equipment connected to it.
4. The Product must have been used at all times within the limitations on the Product's VA capacity.

The Product was designed to eliminate disrupting and damaging effects of momentary (less than 1ms) voltage spikes or impulses from lightning or other power transients. If it can be shown that a voltage spike lasting longer than 1ms has occurred, the occurrence will be deemed outside the rated capabilities of the Product and the Limited Warranty is void. CyberPower Does Not Cover or Undertake Any Liability in Any Event for Any of the Following:

## LIMITED WARRANTY AND CONNECTED EQUIPMENT GUARANTEE (continued)

1. Loss of or damage to data, records, or software or the restoration of data or records, or the reinstallation of software.
2. Damage from causes other than AC Power Line Transients, spikes, or surges on properly installed, grounded and code-compliant 120 volt power lines in the United States and Canada; transients, surges or spikes on standard telephone land lines, PBX telephone equipment lines or Base 10T Ethernet lines, when properly installed and connected. (This exclusion applies, for example, to fluctuations in data transmission or reception, by CATV or RF transmission or fluctuations, or by transients in such transmission.)
3. Damage from any circumstance described as excluded above with respect to the Product.
4. Damages from fire, flood, wind, rain, rising water, leakage or breakage of plumbing, abuse, misuse or alteration of either the product or the Connected Equipment.
5. CyberPower excludes any liability for personal injury under the Limited Warranty and Connected Equipment Guarantee. CyberPower excludes any liability for direct, indirect, special, incidental or consequential damages, whether for damage to or loss of property [EXCEPT FOR (AND ONLY FOR) the specific limited agreement of CyberPower to provide certain warranty benefits regarding "Connected Equipment" under this Warranty], loss of profits, business interruption, or loss of information or data. NOTE: Some States or Provinces do not allow the exclusion or limitation of incidental or consequential damages, so the above limitation may not apply to you.
6. The Product is not for use in high-risk activities or with aquariums. The Product is not designed or intended for use in hazardous environments requiring fail-safe performance, or for use in any circumstance in which the failure of the Product could lead directly to death, personal injury, or severe physical or property damage, or that would affect operation or safety of any medical or life support device (collectively, "High Risk Activities"). CyberPower expressly disclaims any express or implied warranty of fitness for High Risk Activities or with aquariums. CyberPower does not authorize use of any Product in any High Risk Activities or with Aquariums. ANY SUCH USE IS IMPROPER AND IS A MISUSE OF THE PRODUCT.

### Where can I get more information?

The application of the United Nations Convention of Contracts for the International Sale of Goods is expressly excluded. CyberPower is the warrantor under this Limited Warranty.

For further information please feel free to contact CyberPower at CyberPower Systems (USA), Inc. 4241 12th Ave E., STE 400, Shakopee, MN 55379; call us at (877) 297-6937; or send us an e-mail message at [claims@cpsww.com](mailto:claims@cpsww.com).

## CUSTOMER SUPPORT

Visit our website at <https://www.cyberpowersystems.com/support> to access extensive service and in-depth support to gain the information you need about power protection. Use the website links to find answers to common questions, obtain troubleshooting tips, learn about our power management software, view warranty details, and examine product literature. Our online, self-service resources are available 24/7. CyberPower also offers assistance from our expert team of sales, technical, and product support associates.

### Technical Support

Our Technical Support team will be happy help you with technical questions during business hours. Choose the ways described below you would like us to help you.

- Chat Live: Monday – Friday, 7am – 6pm CST. Visit <https://www.cyberpowersystems.com/support>.
- Submit a Form (recommended): Monday – Friday, 24 Hours. Visit <https://www.cyberpowersystems.com/support>.
- Email: Monday – Friday, 7am – 6pm CST. Contact [tech@cpsww.com](mailto:tech@cpsww.com).
- Call Toll Free: Live Monday – Friday, 7am – 6pm CST. Call 1-877-297-6937 (press 1).





Customer Support is available on our website.  
Visit CyberPower at [www.cyberpower.com](http://www.cyberpower.com) to get more information.